



Join the Marina Medical
PREFERRED CUSTOMER CLUB
And start earning valuable rewards
Ask Your Rep Now

Returned Goods Policy

1. Goods will be accepted for return for the following reasons:
 - A. If shipment was made without Customer's authorization;
 - B. If incorrect items were shipped;
 - C. If defective items were shipped;
 - D. If defective goods are covered by the standard warranty;
 - E. If the goods were sent on evaluation basis.
2. To return goods, contact a Customer Service Representative by telephone for an RGA (Returned Goods Authorization) number. The RGA # must also be clearly indicated on the outside of the returned package. Please have the following information:
 - A. Reason you wish to return the goods;
 - B. Quantity, description, product number;
 - C. Date of Receipt of Order;
 - D. Customer's Purchase Order and the Marina Medical invoice number;
 - E. All instruments that have been used must be cleaned and sterilized prior to shipment.
3. Shipment must be returned prepaid by Customer. Freight collect shipments will not be accepted.
4. If Customer intends to return equipment ordered in error; the following restocking charges and terms will apply:
 - A. 25% within 90 days from date of shipment;
 - B. Goods must be returned unused, in the original carton, and in marketable condition;
 - C. Refurbishing and replacement charges will be added to the restocking charges for damaged or missing items;
 - D. No return after 90 days;
 - E. No refund on sterile, single-use disposable products
 - F. No refund will be made on customized instruments.

Send all Returns to:
Marina Medical
955 Shotgun Road
Sunrise, Florida 33326 USA



In Memoriam



Anthony Zinnanti, Jr., Founder

Marina Medical Instruments is sad to announce the passing of our founder, mentor, and friend, Anthony Zinnanti Jr on August 4th, 2010. Anthony was a fixture in the surgical instrument business for over forty years and will be greatly missed. Anthony had a penchant for teaching and sharing his professional experiences with his staff thus Marina Medical shall continue his vision of innovation, quality, and customer support.

- 1998-2010 Founder & President MARINA MEDICAL
- 1993-1998 Consultant BEI MEDICAL (ZINNANTI SURGICAL)
- 1984-1993 Founder & President ZINNANTI SURGICAL INSTRUMENTS
- 1980-1984 Founder & President UNIMAR
- 1975-1978 Vice President CRYOMEDICS/DYONICS

A Message To Our Customers

After completing twelve successful years in business, we at Marina Medical are grateful to each of you for your sustained support and confidence in the Marina Medical product line, thus providing us with another year of outstanding growth.

We would like to take this opportunity to remind you of our Preferred Customer Rewards Program, which shows our gratitude for those who continue to be most loyal to Marina Medical. As a member of the Preferred Customer Club, you will earn higher discounts and free instruments as added value to your regular purchases of Marina Medical instruments.

Every Preferred Customer Club Member receives a monthly statement indicating the number of reward points accumulated and what is available in exchange for these reward points. As always, this program is totally free and without further obligation on behalf of our customers. It is simply our way of saying "Thanks!"

To become a member of Marina Medical's Preferred Customer Club, simply contact your Marina Medical representative and ask for a Preferred Customer application. This application is also available on our website at www.marinamedical.com. As soon as the application is completed and returned, your Rewards Points will begin to accumulate toward future greater discounts and even free instruments.

Please enjoy leafing through the pages of our new catalog. The New Wave in Surgical Instruments continues with the intention of making your surgical objectives easier and safer to achieve.

Alex Barron

Alex Barron
CEO, Marina Medical

TABLE OF CONTENTS

HYSTERECTOMY

MP Clamps	2, 3
MP-IFP Clamps.....	3
Hysterectomy Clamps	3-5
Classic Clamps.....	4
Forceps and Needle Holders	5-6
Vaginal Dissection Scissors.....	6
Parametrium Scissors	7
Speculum	8
Hysterectomy Special Accessories	8

PELVIC SURGERY INSTRUMENTS

Retractors.....	9
Diagnostic Instruments for Pelvic Disorders	10
Lighted Retractors	11
Miyazaki Tack Driver Set	12
Suture Retrieval Hooks.....	12
Tissue Clamps.....	12
Uterosacral Pedicle Clamps	12
Special Instruments for Pelvic Surgery	13
Myotomes	13
Transobturator Sling Needles	13
Martin's Arm	14
VIPA™	15-17
Marina Vaginal Stents	17
<i>Bariatric</i>	
Deep Pelvic Tray.....	18-19
Ligature Carriers	20

CERVICAL UTERINE INSTRUMENTS

Minor Surgery Sets.....	21
Needle Holders.....	21
Cervical and Uterine Instruments	21, 22
Manipulators, Injectors and Catheters	21-23

SPECIALTY INSTRUMENTS

Retractors, Blades, Frames and Retractor Sets	24-33
Four-Armed Customized Retractors.....	24
Deep Pelvic Customized Retractors.....	25
Retractor Blades	24-26, 29-33
Marina Multi-Trac.....	26-33
Sterilization Containers & Baskets	27
Rings	27
Table Mounting Components	28
Retractors	29-31
Sterilization Supplies	31
Retractor Sets	32, 33

BIOPSY AND COLPOSCOPY

Endometrial Samplers (MASI).....	34
Reusable OS Finder Set	35
4-Bladed Vaginal Speculum	35
Marina Specialty Vaginal Specula.....	36
Marina Open-Sided Specula.....	37
Side Wall Retractors	37
Disposable Specula	38
Vaginal Dilator Sets, Dilators	38, 39
Marina Biopsy Punches	40, 41
Kogan Endocervical Specula	41
Marina Endocervical Curettes	41, 44
Myoma Grasping Forceps	42
Marina Cervical Hooks	42
Needle Extensions.....	42

MICROSURGERY

Scissors, Handles, Forceps and Dissection Needles	43
---	----

GYN BASIC INSTRUMENTS

Curettes, Dilators and Sounds.....	44
Tenacula	44
Marina IUD Hooks & Polyp Forceps.....	45

ELECTRO-SURGICAL INSTRUMENTATION

Lletz Program.....	46
Non-Conductive Instruments.....	47, 48
Lletz Electrode Chart	49
Lletz Accessories	50
Smoke Evacuation Systems.....	51
Accessories for Smoke Evacuation.....	51, 52
Smoke Evacuation Tubing Sets	52

PESSARIES

Ring, Oval, Shaatz, Gellhorn, Dish, Mar-Land, Hodge, Gehrung, Donut, Cube.....	53-56
--	-------

COLOSCOPES

Overhead Zoom Colposcope/Video Overhead Zoom	57
Zoom /Video Colposcope	58
Diagnostic Colposcope.....	59
High Resolution Color-Video Camera	60
Colposcope Accessories	60
Portable Headlight System.....	61
Surgical Loupes	61

TURNKEY OFFICE HYSTEROSCOPY SYSTEM

Camera, Coupler, Light Sources, Monitors, Cable, Hysteroscope, Sheaths, Scissors, Forceps	62, 63
Flexible Instruments for Hysteroscopy System	64

DIAGNOSTIC & OPERATIVE ENDOSCOPY

Scopes.....	65
Diagnostic Sheaths.....	66
Obturator.....	66
Continuous Flow Operating Sheaths.....	66
Operating Sheaths.....	67
Resectoscopy Instruments	68
Resectoscopy Electrodes.....	69
Endoscopy Accessories.....	70
Containers for Endoscopy	70
Hasson Grasper	71
Instruments for Puncture.....	71
S-Shaped Retractors.....	71
Tissue Clamps	71
Accessories (Trocars, Caps).....	72
Instruments for Laparoscopy	73, 74
Cannula Sheaths & Trocars.....	73, 74
Accessories (Reduction Sleeve, Holders, Reducers)	74
3-Blade Retractor	75
Dilators.....	75
Insufflation Needle.....	75
Suction & Irrigation Systems, Cannulas	75-77
Handle Styles for Endoscopic Instruments.....	77
Rotable and Detachable Scissors.....	78
Rotable and Detachable Biopsy Forceps.....	79
Rotable and Detachable Grasping Forceps	80-87
Clip Application Forceps	88
Cholangiography Forceps for Catheters	88
Needle Holders	89
Knot Pushers.....	90
Fan Retractors	90
Electrodes with Handles	90
Bipolar Instrumentation	91
Accessories (Cable and Sterilization)	92

CONTAINERS

Containers and Matching Trays	93-95
Accessories.....	95
Vasectomy Sets	95

PREFERRED CUSTOMER CLUB PROGRAM

INDEX

Inside Back Cover





The Tissue is Secure with... MP™ (MARINA PARAMETRIUM) HYSTERECTOMY CLAMPS

MP™ Clamps are well-balanced and have a sturdy, atraumatic longitudinal groove that guarantees a secure grip of tissue and prevents slippage. The MP™ Hysterectomy Clamps are available in **five lengths** and five jaw configurations.

ZEPPELIN-STYLE CLAMPS

Product Description Product No.

Straight w/ Gold Rings

21 cm, 8.25 in.	336-411
24 cm, 9.5 in.	336-541
30 cm, 12 in.	336-601
35 cm, 14 in.	336-661
41 cm, 16 in.	336-911

Angled Shaft

21 cm, 8.5 in.	336-711
24 cm, 9.5 in.	336-741
30 cm, 12 in.	336-801
35 cm, 14 in.	336-861

Product Description Product No.

Slightly Curved w/ Gold Rings

21 cm, 8.25 in.	336-412
24 cm, 9.5 in.	336-542
30 cm, 12 in.	336-602
35 cm, 14 in.	336-662
41 cm, 16 in.	336-912

Angled Shaft

21 cm, 8.5 in.	336-712
24 cm, 9.5 in.	336-742
30 cm, 12 in.	336-802
35 cm, 14 in.	336-862

Product Description Product No.

Strongly Curved w/ Gold Rings

21 cm, 8.25 in.	336-413
24 cm, 9.5 in.	336-543
30 cm, 12 in.	336-603
35 cm, 14 in.	336-663
41 cm, 16 in.	336-913

Angled Shaft

21 cm, 8.5 in.	336-713
24 cm, 9.5 in.	336-743
30 cm, 12 in.	336-803
35 cm, 14 in.	336-863

Product Description Product No.

Angulated w/ Gold Rings

21 cm, 8.25 in.	336-414
24 cm, 9.5 in.	336-544
30 cm, 12 in.	336-604
35 cm, 14 in.	336-664
41 cm, 16 in.	336-914

Angled Shaft

21 cm, 8.5 in.	336-714
24 cm, 9.5 in.	336-744
30 cm, 12 in.	336-804
35 cm, 14 in.	336-864

Product Description Product No.

MP Vaginal Cuff Clamp

Jaw length — 50 mm	
24 cm, 9.5 in.	336-669
30 cm, 12 in.	336-670



35 cm
Angled

30 cm
Fully curved

24 cm
Slightly curved

21 cm
Straight



Latest Additions to the MP Family
MP-IFP CLAMP
 (Infundibular Pelvic Clamp)

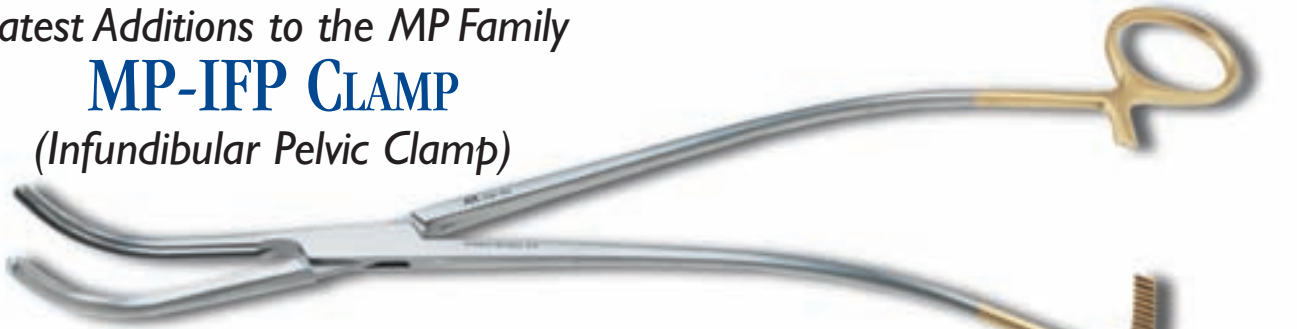

- The **Marina IFP Clamp** is perfectly shaped to reach high into the pelvis during vaginal hysterectomy salpingo-oophorectomy (BSO)
- The S-shaped shanks of the instrument are out of the way of the surgeon
- The 70 mm jaw length is able to envelop the infundibular pelvic ligament and round ligament simultaneously
- The **MP-IFP-XL Clamp** offers the extra length of two inches proximal to the box lock to accommodate the larger patient

Product Description

Product No.

MP-IFP Clamp, 11 in.

336-150

MP-IFP-XL Clamp, 13 in.

336-152



New Techniques in Vaginal Surgery Require New Surgical Instrumentation. Introducing the
KOVAC HYSTERECTOMY CLAMP



336-541K



336-542K



336-543K

When a stronger bite is what you are looking for, the **Kovac Hysterectomy Clamp** combines the gentleness of the MP Clamp with the security of the Heaney-Ballentine notches.

Product Description

Product No.

Kovac Clamp, 24 cm, 9.5 in., Straight

336-541K

Kovac Clamp, 24 cm, 9.5 in., Slight Curved

336-542K

Kovac Clamp, 24 cm, 9.5 in., Strong Curved

336-543K



All **MP™ Clamps** are available with angled shanks for greater scissoring space and clamping ability.



Classics With Quality...

HEANEY-BALLENTINE HYSTERECTOMY CLAMP

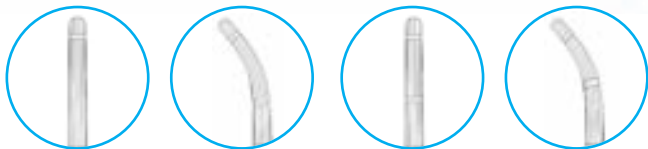

Straight/Single Curved/Single Straight/Double Curved/Double

Product Description	Product No.
21 cm, 8.25 in., Straight, Single Groove	336-376
21 cm, 8.25 in., Curved, Single Groove	336-378
21 cm, 8.25 in., Straight, Double Groove	336-380
21 cm, 8.25 in., Curved, Double Groove	336-382
25 cm, 10 in., Straight, Single Groove	336-384
25 cm, 10 in., Curved, Single Groove	336-385
25 cm, 10 in., Straight, Double Groove	336-387
25 cm, 10 in., Curved, Double Groove	336-386

Also available in 12 and 14 inch lengths

ROGERS HYSTERECTOMY CLAMP



Straight Slightly Curved Strongly Curved Angled

Product Description	Product No.
22 cm, 8.5 in., Straight	336-130
22 cm, 8.5 in., Slightly Curved	336-131
22 cm, 8.5 in., Strongly Curved	336-132
22 cm, 8.5 in., Angled	336-133

MASTERSON HYSTERECTOMY CLAMP



Straight Curved

Product Description	Product No.
22 cm, 8.5 in., Straight	336-222
22 cm, 8.5 in., Curved	336-322
25.5 cm, 10 in., Straight	336-226
25.5 cm, 10 in., Curved	336-326

HEANEY HYSTERECTOMY CLAMP



Straight/Single Curved/Single Straight/Double Curved/Double

Product Description	Product No.
21 cm, 8.25 in., Straight, Single Groove	336-340
21 cm, 8.25 in., Curved, Single Groove	336-342
21 cm, 8.2 in., Straight, Double Groove	336-370
21 cm, 8.25 in., Curved, Double Groove	336-372
30 cm, 12 in., Straight, Single Groove	336-360
30 cm, 12 in., Curved, Single Groove	336-362
30 cm, 12 in., Curved, Double Groove	336-366



More Hysterectomy Clamps...

GLENNER HYSTERECTOMY CLAMPS

Prod. Description	Length	Product No.
Curved left	8 1/4 in.	336-142
Curved right	8 1/4 in.	336-144

- Ideal in vaginal hysterectomy to grasp lower ligaments
- Curved for right and left side performance
- Longitudinal serrations provide secure grasping



M.D. ANDERSON CLAMP

- Ideal for clamping adnexal tissue during hysterectomy
- Longitudinal serrations in atraumatic jaws

Product Description	Product No.
10 in.	336-125
11 in.	336-128
14 in.	336-129



CLARK CLAMP

- Used for tunneling around ureters during pelvic surgery
- Longitudinal serrations in jaw gently grasp tissue

Product Description	Product No.
8 3/4 in.	336-021
12 in.	336-022
14 in.	336-024



NOLAN NEEDLE HOLDER

- Extended boxlock prevents torquing of shanks
- Long and extra long length for deep surgery

Product Description	Product No.
10 in.	420-865
12 in.	420-870
12 in. CVD Tip	420-871
14 in.	420-875
14 in. CVD Tip	420-876



Forceps and Needle Holders

LAHEY FORCEPS



Product Description	Product No.
Lahey Forceps, Sharp Teeth, Two prong: 20 cm / 8 in.	330-571
Lahey Forceps, Sharp Teeth, Three prong: 25 cm / 10 in.	330-572

HEANEY NEEDLE HOLDER



Product Description	Product No.
Heaney Needle Holder - Curved,TC Inserts: 21 cm / 8.25 in.	420-540
Heaney Needle Holder - Curved,TC Inserts: 26.5 cm / 10.5 in.	420-546

Vaginal Dissection Scissors

MAYO-NOBLE



Product Description	Product No.
Mayo-Noble Dissection Scissors	050-148

ZIMMERMAN-YAGI



Product Description	Product No.
Zimmerman-Yagi Dissection Scissors	050-160

METZENBAUM

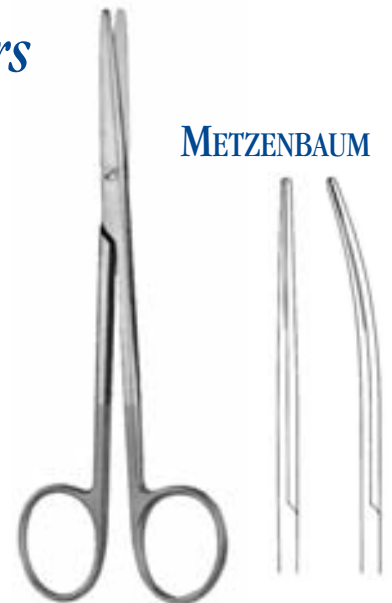

Prod. Description	Straight	Curved
11.5 cm / 4.5 in.	050-175	050-176
14.5 cm / 5.75 in.	050-179	050-180
18 cm / 7.0 in.	050-181	050-182
20 cm / 8.0 in.	050-183	050-184
23 cm / 9.0 in.	050-186	050-188



The Complete Source for Pelvic Reconstructive Surgical Instrumentation

Precision in Cutting MP™ (MARINA PARAMETRIUM) SCISSORS

MP™ Scissors are a complete set of Parametrium scissors designed to match precisely to the MP™ Hysterectomy Clamp jaw curvatures. The MP™ Scissors guarantee precise cutting. The scissors feature tungsten serrated blades to ensure tissue does not slip during cutting. The MP™ Scissors are available in four lengths and three jaw configurations.



Product Description **Product No.**

Slightly Curved w/ Gold Rings

23 cm, 9 in.	410-123
26.5 cm, 10.5 in	410-126
30 cm, 12 in.	410-130
35 cm, 14 in.	410-333



Product Description **Product No.**

Strongly Curved w/ Gold Rings

23 cm, 9 in.	410-223
26.5 cm, 10.5 in	410-226
30 cm, 12 in.	410-230



Product Description **Product No.**

Angulated w/ Gold Rings

23 cm, 9 in.	410-323
26.5 cm, 10.5 in	410-326
30 cm, 12 in.	410-330
35 cm, 14 in.	410-335
41 cm, 16 in. (Jorgensen)	410-337



**NOW AVAILABLE
IN 16 INCH
LENGTH!**



Hysterectomy Special Accessories

252-055

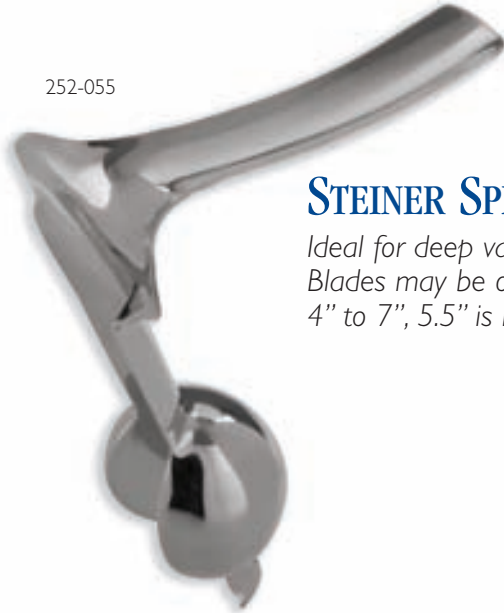

STEINER SPECULUM

Ideal for deep vaginal surgery. Blades may be ordered from 4" to 7", 5.5" is normal length.

Product Description

1.1 Kg / 2.5 lb:
14 cm x 3 cm / 5.5 in. x 1.25 in.

Product No.

252-055

252-020



HARDY-DUDDY SPECULUM

It will not fall out. Design places the 3.5 lbs weight at a right angle to the shaft of the speculum, preventing expulsion. Many blade options are available.

Product Description

Hardy-Duddy Speculum,
3.5 lbs., 120 mm x 35 mm / 5.5 in.,
cupped blade

Product No.

252-020



AUWARD SPECULUM

An assortment of weighted Auvard specula is available.

Product Description

1.1 Kg / 2.5 lb:
8.5 cm x 4 cm / 3.5 in. x 1.5 in.

Product No.

252-009

1.1 Kg / 2.5 lb:
10 cm x 4.5 cm / 4 in. x 1.75 in.

252-010

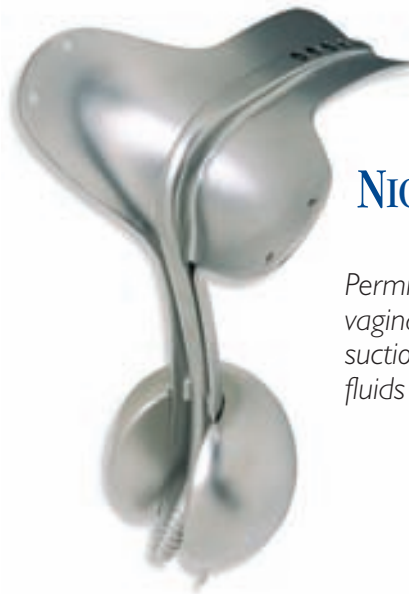

NICHOLS WEIGHTED SPECULUM

Permits retraction of posterior vaginal wall, while providing suction and measurement of fluids from the surgical site.

Product Description

Nichols Vaginal Weighted Speculum
with Suction, 2.5 lbs. 2.75 in. x 1.5 in.

Product No.

350-180



BREISKY RETRACTORS

Product Description	Product No.
100 mm x 18 mm	254-407
100 mm x 25 mm	254-410
100 mm x 30 mm	254-412
100 mm x 35 mm	254-414
100 mm x 38 mm	254-415
120 mm x 30 mm	254-512
130 mm x 35 mm	254-514
140 mm x 35 mm	254-516
150 mm x 35 mm	254-613
160 mm x 35 mm	254-615
170 mm x 25 mm	254-620
170 mm, heart-shaped	254-622

PELOSI VR RETRACTORS



- Ergonomically shaped and lightweight handle
- Perforations in the blade provide traction against the vaginal wall to prevent the retractor from slipping
- The "Z"-shape of the retractor enables the assistant to keep his hand away from the surgical field so the surgeon has optimal exposure

Product Description	Product No.
Small, 30 mm x 90 mm	254-519
Large, 35 mm x 110 mm	254-518

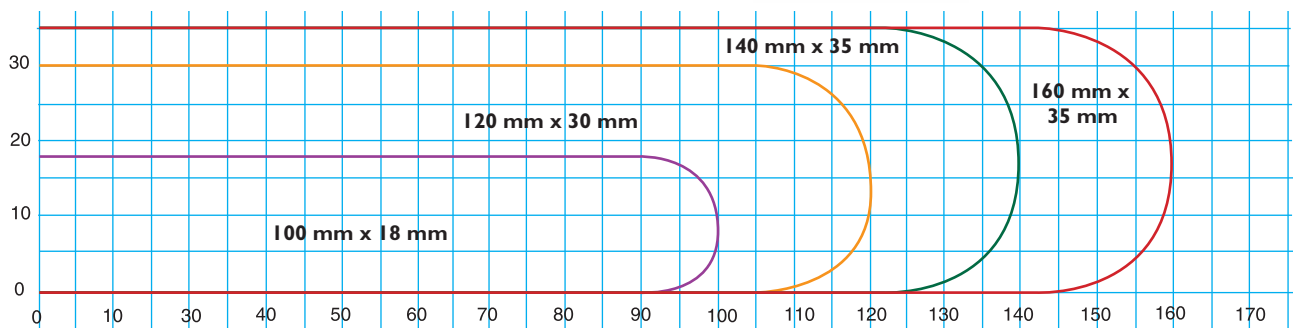

VERONIKIS VAGINAL RETRACTORS

Designed to achieve maximum visibility in the narrow vaginal operative tunnel.

Product Description	Product No.
1 in. (2.5 cm) blade width, 12 in. length	254-701
1 in. (2.5 cm) blade width, 13.5 in. length	254-701C
1.5 in. (3.8 cm) blade width, 12 in. length	254-702
1 in. (2.5 cm) Tapered blade, 12 in. length	254-704

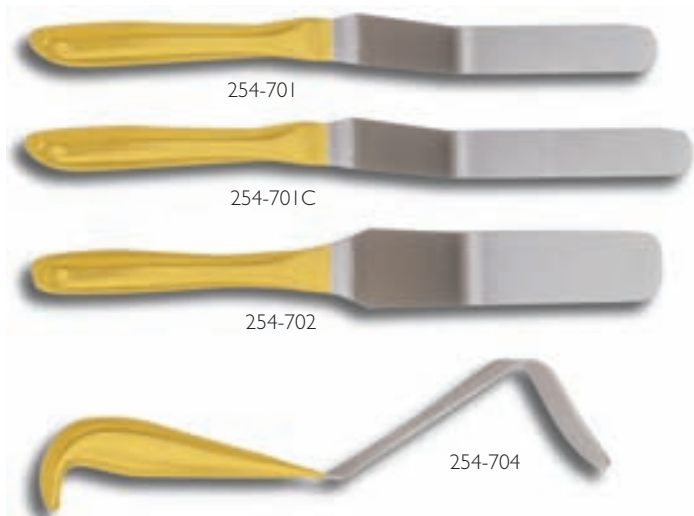

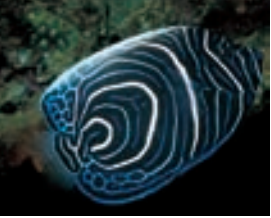

The New Wave in GYN

Diagnostic Instruments for Pelvic Disorders

POP-Q EXAM STICK

Easy to use • Cost-effective • Accurate
Ink-free disposable
wooden sticks

POPstix

The POP-Q Exam stick is the main clinical tool to identify the severity of pelvic organ prolapse and the anatomical success or failure of prolapse surgery.

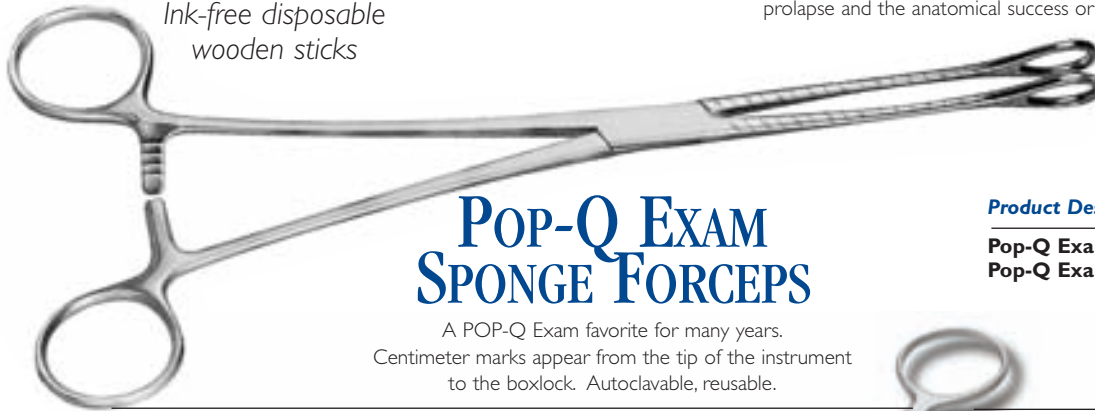

POP-Q EXAM SPONGE FORCEPS

A POP-Q Exam favorite for many years. Centimeter marks appear from the tip of the instrument to the boxlock. Autoclavable, reusable.

Product Description	Product No.
Pop-Q Exam Stick, box of 50	222-222
Pop-Q Exam Sponge Forceps	350-225

350-220

BADEN VAGINAL DEFECT ANALYZERS

For evaluation of paravaginal defects as presented by Wayne Baden, M.D.



350-222

Product Description

The **original style** as defined by Dr. Baden with 2 1/4 inch long blades, slightly angled
The **Baden-Nichols style** with 1 1/2 inch, deeply angled blades, more specific to level 2 of the vagina

Product No.

350-220
350-222

MARINA MASSON FASCIALATA STRIPPER

For precise harvesting of fascialata (a short video showing technique is available upon request).



Product Description	Product No.
Stripper, 1 cm (Inner Diameter)	350-400
Stripper, 2 cm (Inner Diameter)	350-402
Complete set of 2	350-412

WALTHER URETHRAL CATHETERS

Classic bladder filling and emptying catheter, stainless steel.



Product Description	Product No.
12 FR	220-312
14 FR	220-314
16 FR	220-316
18 FR	220-318
20 FR	220-320
22 FR	220-322
24 FR	220-324
26 FR	220-326
28 FR	220-328
30 FR	220-330
32 FR	220-332
34 FR	220-334
Set of 12, 12-34	220-300

Also available - Urethral Sounds



MIYAZAKI LIGHTED RETRACTORS™

Lighted Retractors That Make Sense!

A. Miyazaki All-Purpose Retractor

Useful in modified Burch procedures, sacrospinous suspension of prolapsed vault and other transvaginal procedures.

B. Miyazaki Sacropexy Retractor

Useful in sacrocolpopexy and other abdominal approach sacral procedures.

C. Marina Lighted Breisky Retractor with Light Pipe built-in

The most commonly used retractor now available with pin-point light.

D. Marina Heaney-Simon Lighted Retractor with Light Pipe built-in

The most popular anterior wall retractor with a convenient out-of-the-way fiberoptic light.

E. Marina Lighted Yankauer Suction Tube with Light Pipe built-in

At your request, the most popular suction tube in GYN surgery, now with the convenience of available light even in the darkest surgeries.

F. Marina “Triple Threat” Suction Tube with Light Pipe & Irrigation built-in

Our newest and most popular blunt dissection instrument. Combines suction, irrigation and light. Cost effective.

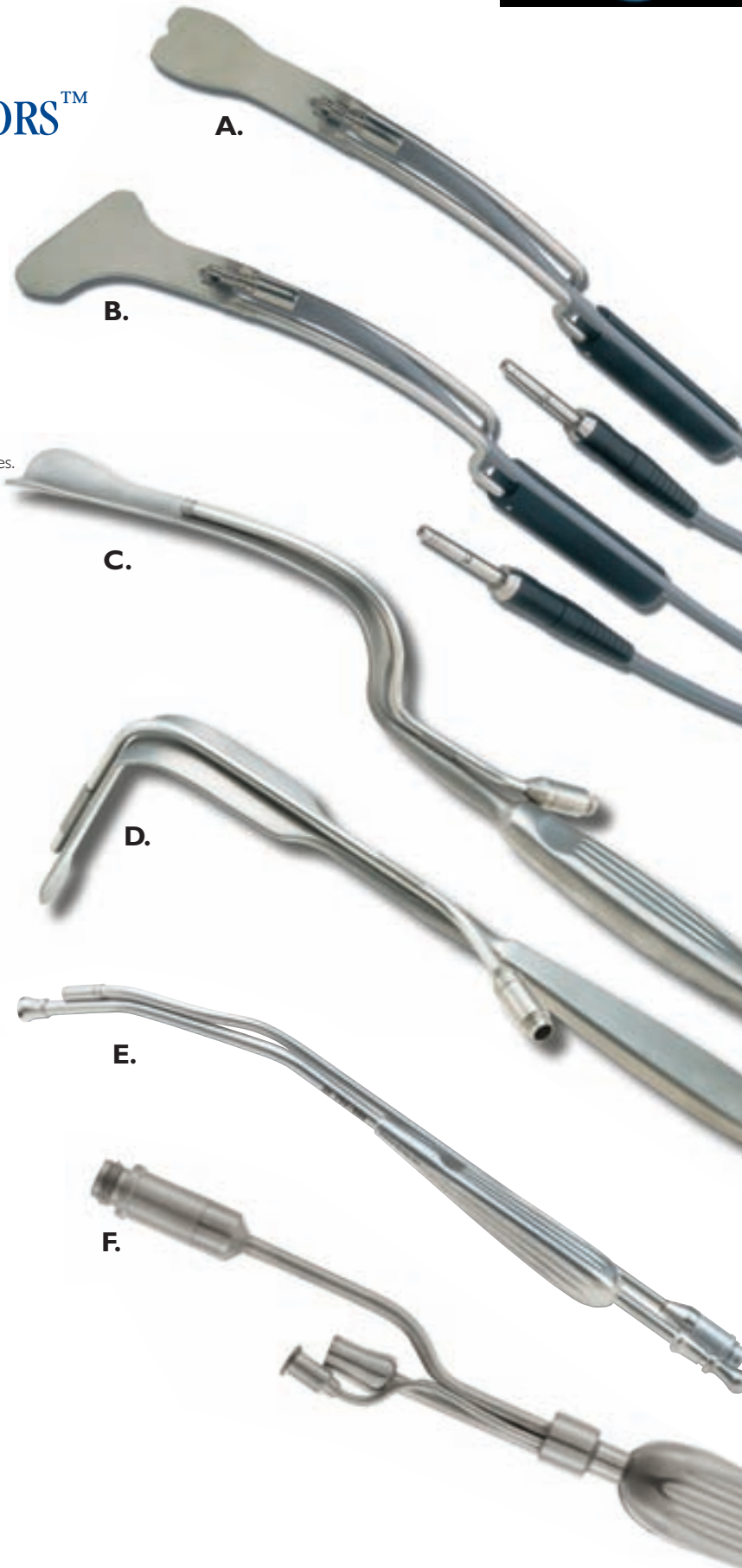

<i>Product Description</i>	<i>Product No.</i>
Miyazaki All-Purpose Retractor	254-630
Miyazaki Sacropexy Retractor	254-632
Marina Lighted Breisky Retractor	254-640
Marina Heaney-Simon Lighted Retractor	254-642
Marina Lighted Yankauer Suction Tube	254-644
Marina “Triple Threat” Yankauer Suction Tube	254-648



MIYAZAKI TACK DRIVER™ SET

For Sacral Bleeding During Pelvic Surgery

When the only achievable hemostasis is through permanent sacral tack positioning. One piece titanium.

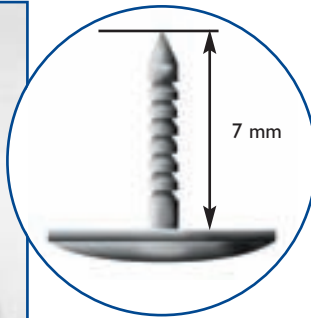

Product Description

- Miyazaki Tack Driver
- Miyazaki Mallet
- Hemorrhage Occluder Pin, (Box of 1), sterile
- Hemorrhage Occluder Pin, (Box of 2), sterile

Product No.

- 337-240
- 337-242
- 337-244
- 337-245

SUTURE RETRIEVAL HOOK

Stiff shaft to distal end eases difficulty of suture retrieval.



Product Description

- Suture Retrieval Hook, 27 cm / 10.5 in.
- Suture Retrieval Hook, Sims Handle, 27 cm / 10.5 in. .

Product No.

- 295-310
- 295-310S

KROBACH TISSUE CLAMP

Ideal to grasp the posterior vaginal wall and perianal tissue when dissecting in the pararectal space.



10mm Jaw

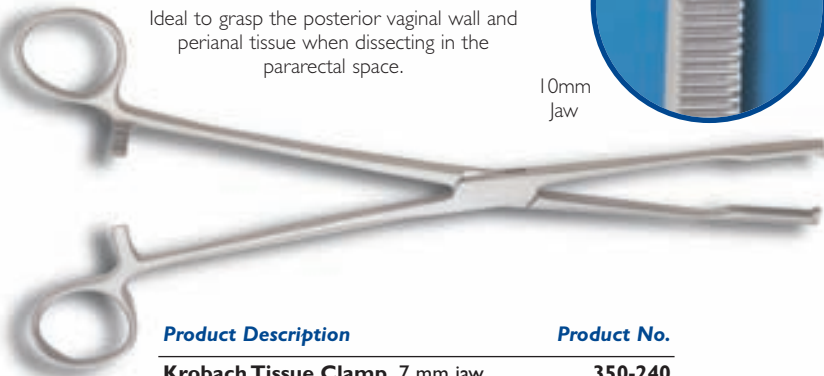

Product Description

- Krobach Tissue Clamp, 7 mm jaw
- Krobach Tissue Clamp, 10 mm jaw

Product No.

- 350-240
- 350-242

Uterosacral Pedicle Clamps



McCALL UTEROSACRAL PEDICLE CLAMP™

Ideally shaped to grasp the uterosacral pedicle when positioning suture.



350-252

UTEROSACRAL ALLIS FORCEPS

201-021
201-023



REEVES PEDICLE CLAMP, 90°

070-559



Product Description

- McCall Uterosacral Pedicle Clamp
- Reeves Uterosacral Pedicle Clamp, 90°
- Uterosacral Allis Forceps, Curved, 19 cm / 7.5 in.
- Uterosacral Allis Forceps, Curved, 24 cm / 9.5 in.

Product No.

- 350-252
- 070-559
- 201-021
- 201-023

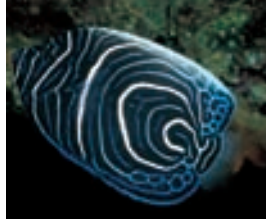

The Complete Source for Pelvic Reconstructive Surgical Instrumentation

Special Instruments for Pelvic Disorders

THE ZIMMERMAN MYOTOME INSTRUMENT SET

For use during vaginal delivery of myomatous uteri.

Uniquely designed myotomes help morsellate and remove myoma quickly and with minimum trauma. Zimmerman Graspers hold the myoma firmly while the Zimmerman Myotomes are used to enucleate the myoma from surrounding tissue. A complimentary video (332-420) is available to show this myomectomy technique. Ask your Marina Medical Rep for a copy.



Product Description

Product No.

Zimmerman Myotome Instrument Set (4 items)	332-400
Includes Chisel Tip, Spoon Tip Myotome, Grasper, 8 mm & Grasper, 13 mm	
Zimmerman Myotome, Chisel Tip, 29 cm	332-410
Zimmerman Myotome, Spoon Tip, 24 cm	332-412
Zimmerman Myotome Grasper	332-414
3 x 3 Teeth x 8 mm wide, 25 cm / 10 in.	
Zimmerman Myotome Grasper	332-416
3 x 3 Teeth x 13 mm wide, 20 cm / 8 in.	
Martin Myomectomy Scissors Straight, Serrated, 20 cm / 8 in.	050-532
Martin Myomectomy Scissors Curved, Serrated, 20 cm / 8 in.	050-534

TRANSOBTURATOR SLING NEEDLES



Product Description

Product No.

Transobturator Sling Needle, Type I, Short, pair (L & R)	350-007
Transobturator Sling Needle, Type II, Short, pair (L & R)	350-008
Transobturator Sling Needle, Type III, Long (Anterior/Posterior)	350-009



A Cost Effective, Valuable O.R. Assistant

MARTIN'S ARM

- Attaches to the O.R. Table
- Steadier than the Human Hand
- Eliminates Shake & Fatigue
- Adjusts to Any Height or Angle
- Quick Adjust & Lock Control

Use Martin's Arm with Breisky Retractors (see page 15)



Breisky Retractors

110-652
or
110-655

254-620

110-652 or 110-655

254-516

Martin's Arm Table Assistant Clamp provides complete rotation whether O.R. table track is horizontal or vertical.

110-655 plus 110-660
or 110-660A

110-660A

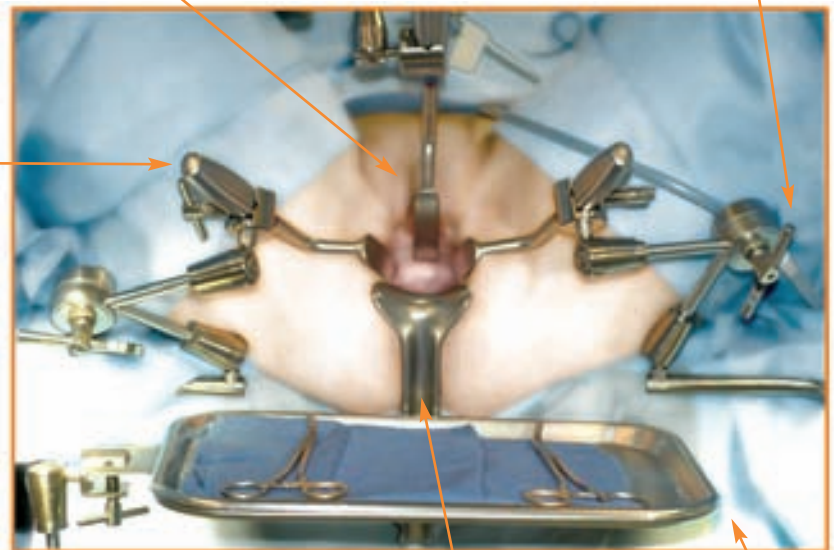

252-055

110-655-020
and
110-655-030

MARTIN'S ARM TABLE ASSISTANT SET

Product Description

- Martin's Arm with Clamp**, 22 in. x 10 in., L-Stand (extended), 45 in. height
- Martin's Arm Table Assistant**, 33 in. height (Table Clamp #110-660 not included)
- Martin's Arm Retractor Table Clamp**
- Mini Mayo Tray for Martin's Arm**
- Tray Holder for Martin's Arm**
- Steiner Speculum**, 1.1 Kg / 2.5 lb; 14 cm x 3 cm / 5.5 in. x 1.25 in.
- Breisky Retractor** - 140 mm x 35 mm / 5.5 in. x 1.3 in.
- Breisky-Navratil Retractor** - 170 mm x 25 mm / 6.75 in. x 1 in.

Product No.

- 110-652
- 110-655
- 110-660A
- 110-655-020
- 110-655-030
- 252-055
- 254-516
- 254-620



TAKE CONTROL

with



VERONIKIS INTRA-FIBEROPTIC PELVIC ASSISTANT

The Most Exciting New Instrument Available for:

- Sacrocolpopexy
- Paravaginal Repair
- Urethropexy
- Rectovaginal Septum Endometriosis

Illumination helps:

- Find the Apical Scar
- Pinpoint suturing on steady platform
- Avoid suturing thinned out tissue

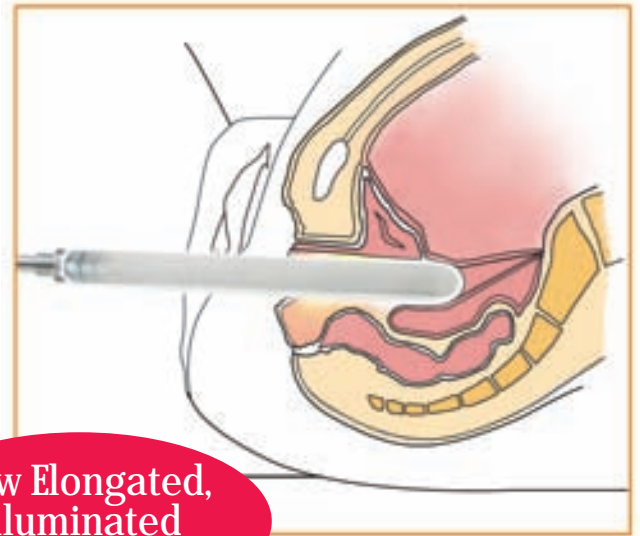

New Elongated, Illuminated Suture Platforms

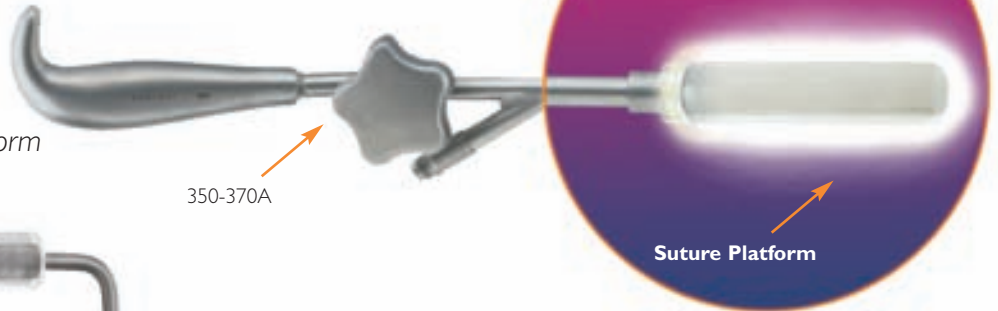

350-370A

Suture Platform



350-408

350-407

MARINA VAGINAL CUFF SUTURE PLATFORMS

New Suture Platforms are 12 centimeters in length allowing illuminated examination of vaginal tissue and a continuous suturing platform for the entire length of the vagina.

VIPA™ SUTURE PLATFORMS

Product Description	Product No.
0.75 in. / 19 mm diameter, 12 cm length	350-403
1.00 in. / 25 mm diameter, 12 cm length	350-404
1.25 in. / 31 mm diameter, 12 cm length	350-405
Flat Sided Suture Platform, 10 in. x 1.75 in. diameter	350-407
Metal Handle with Stent, 10 in. x 1.25 in. diameter	350-408

THE SET
Actual size diameters



19 mm

25 mm

31 mm



The New Wave in GYN

TAKE CONTROL

Of Your
Vaginal Repair Procedures

THE TAKE CONTROL SYSTEM INCLUDES:

- Martin's Arm Table Assistant
- 360° Rotatable Table Clamp
- VIPA™ - Fiberoptic Pelvic Assistant

- Marina Vaginal Cuff Suture Platform



**NEW,
ELONGATED,
ILLUMINATED!**

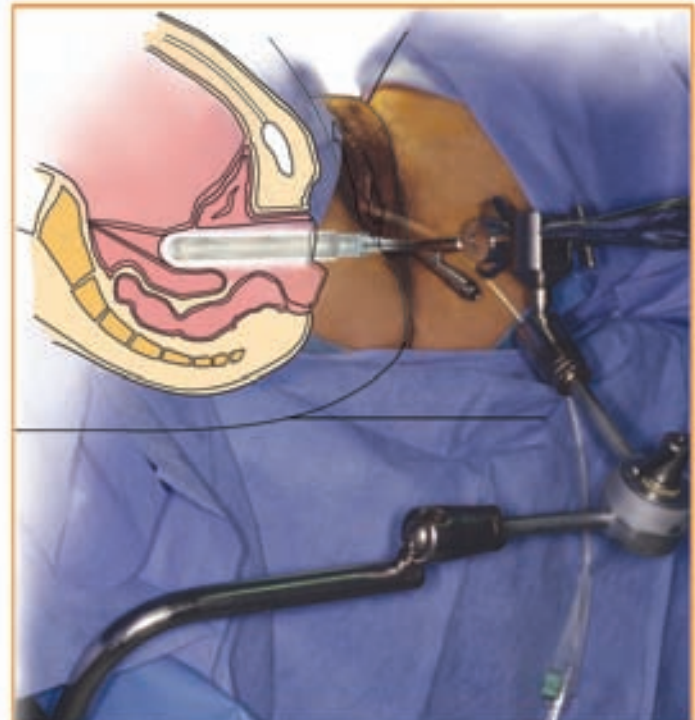



with other
TAKE CONTROL **VIPA™** TIPS



350-374D
350-375

350-376

350-378

350-380

Product Description

Product No.

VIPA Urethropexy Replacement Dome Tip	350-374D
VIPA Urethropexy Elbow	350-375
VIPA Vaginal Cuff Suture Platform (small)	350-376
VIPA Vaginal Cuff Suture Platform (large)	350-378
VIPA Rectal Probe	350-380

MARINA VAGINAL STENTS

For hand held use in the O.R. during vaginal surgery. Marina Vaginal Stents are 10 inches long and come in a set of three different diameters:

- 18 mm (3/4 in.)
- 25 mm (1 in.)
- Urethropexy
- 31 mm (1 1/4 in.)

Custom sized diameters are available upon request.

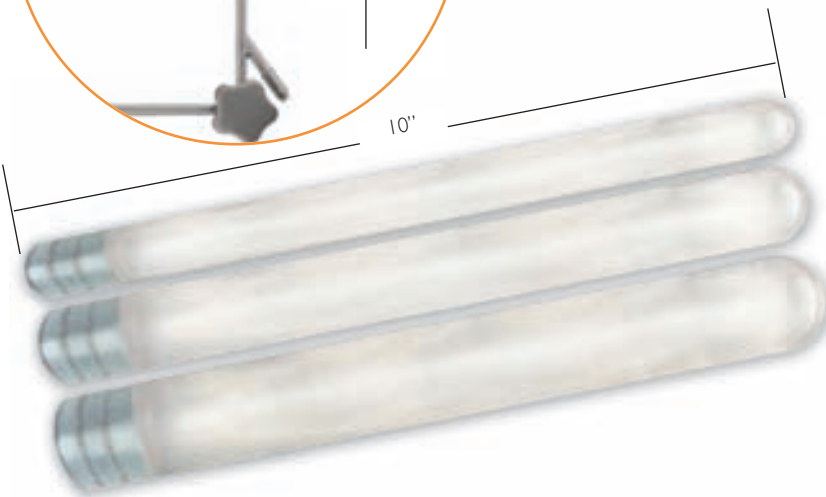
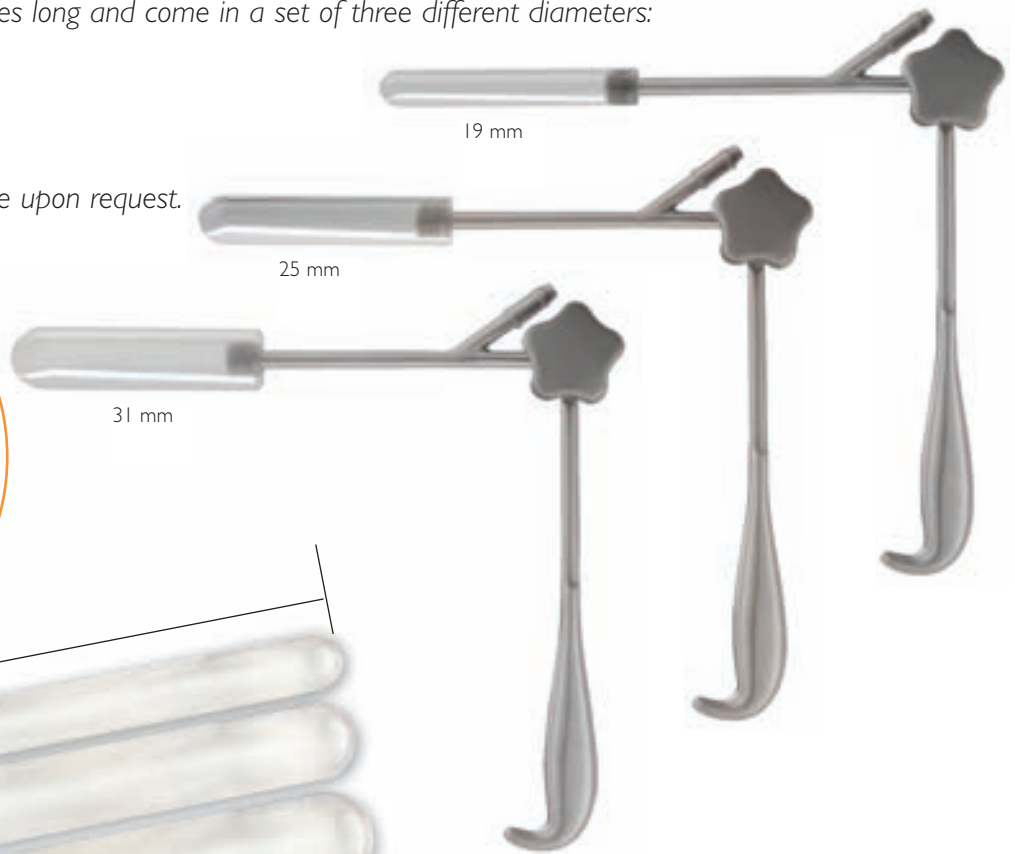
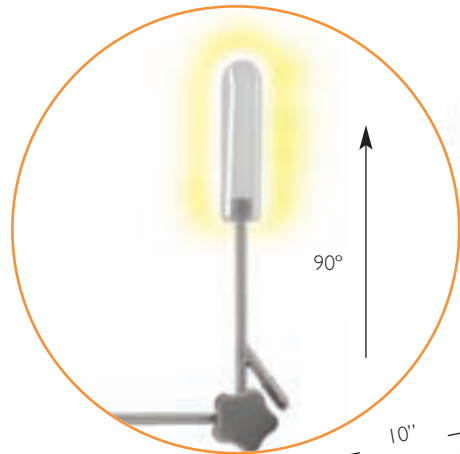

MARINA LUCITE VAGINAL STENTS

Product Description

Product No.

0.75 in. / 19 mm Diameter, 10 in. length	350-382
1.00 in. / 25 mm Diameter, 10 in. length	350-384
1.25 in. / 31 mm Diameter, 10 in. length	350-386



The New Wave in GYN

Marina Medical proudly responds to the need for longer instruments during abdominal hysterectomy and related oncology procedures. Well organized and extremely complete, the surgeon has a selection from over 20 different instruments.

Custom Sizes Available



To keep your extra-long instruments neatly packaged and well organized, Marina Medical offers a custom-fitted, sterile container and basket.

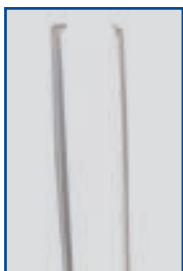

Tissue Forceps

- 060-052-12"
- 060-054-14"
- 060-056-16"
- 060-057-18"



Single Forceps

- 060-304-12"
- 060-306-14"
- 060-308-16"
- 060-309-18"



De Bakey Forceps

- 060-504-12"
- 060-506-14"
- 060-507-16"
- 060-508-18"



Kocher Forceps

- 070-303-12"
- 070-305-14"
- 070-305XL-16"



Metzenbaum Scissors

- 410-134-12"
- 410-135-14"
- 410-135XL-16"
- 410-135XXL-18"



Gemini/Mixer Forceps

- GEM070-353-12"
- GEM070-355-14"
- GEM070-355XL-16"
- MIX070-365-14"
- MIX070-365XL-16"



Sponge Forceps

- 070-650-14"
- 070-655-16"
- 070-657-16", Curved



The Complete Source for Pelvic Reconstructive Surgical Instrumentation



Product Description

Sterilization container, 23 in. x 11 in. x 5.9 in.
Sterilization basket, 21.5 in. x 10 in. x 3.9 in.

Product No.

020-044
020-045

THE DEEP PELVIC TRAY

Instruments
Up To
18"



MP Parametrium Clamps -14" and 16"

- 336-661 Straight 14"
- 336-662 Slightly Curved 14"
- 336-663 Full Curved 14"
- 336-664 Angled 14"
- 336-991 Straight 16"
- 336-912 Slightly Curved 16"
- 336-913 Full Curved 16"
- 336-914 Angled 16"



Babcock Forceps

- 161-530-12"
- 161-535-14"
- 161-536-16"
- 161-537-18"



Cushing Vein Retractor

- 110-311-12"
- 110-312-14"
- 110-316-16"



MP Parametrium Scissors

- 410-333 Slightly Curved
- 410-335 Full Curved, 14"
- 410-337 Full Curved, 16"



Heaney Needle Holder

- 420-548-12"
- 420-550-14"
- 420-552-16"



Allis Forceps

- 160-335-12"
- 160-340-14"
- 160-342-16"
- 160-344-18"

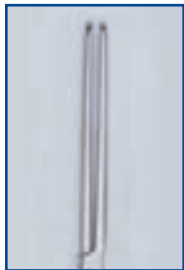

Rochester Pean Forceps

- 070-313-12"
- 070-315-14"
- 070-315XL-16"



Yankauer Suction

- 190-620-14"
- 190-622-16"
- 190-624-18"



MD Anderson Forceps

- 336-128-11"
- 336-129-14"
- 336-129XL-16"



Masson Needle Holder

- 420-435-14"
- 420-437-16"



Nolan Needle Holder

- 420-870-12"
- 420-875-14"
- 420-877-16"
- 420-878XXL-18"



Clark Artery Forceps

- 336-022-12"
- 336-024-14"
- 336-026-16"



The New Wave in GYN

VERONIKIS LIGATURE CARRIER™

The Most Refined Instrument Ever Designed for Sacrospinous Vault Suspension

Product Description

Product No.

Veronikis Ligature Carrier™ 350-360

Designed and developed by Dionysios K. Veronikis, M.D. St. Louis, Missouri

- Designed for Ligature Suspension of Prolapsed Vaginal Vault
- Needle configuration designed to pierce the sacrospinous ligament correctly with secure bite
- Needle configuration allows simplified suture retrieval
- Does not slice the ligament
- Suture hole size permits multiple suture placement
- Suture anchors on lateral sides of instrument work very efficiently to keep multiple sutures organized

This instrument available for clinical evaluation. Ask for the FREE video case presentation. 350-365

Needle contour prevents tissue slicing. Width of jaw opening allows application of generous bite.

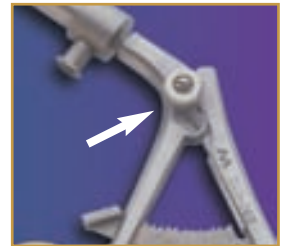

Suture anchor designed as a thumb screw. Easy to open, wrap suture and secure.



MIYAZAKI LIGATURE CARRIER SET™

A Time Honored Approach to Sacrospinous Suspension of Prolapsed Vaginal Vault

- The first ligature carrier made specifically for sacrospinous suspension
- Articulating distal ligature needle allows confident suturing through the sacrospinous ligament

Product Description

Product No.

Miyazaki Ligature Carrier,™ 20 cm Shaft	337-200
Breisky Navratil Retractor, 170 mm x 25 mm Blade	254-620
Suture Retrieval Hook, Fine Ended, 27 cm / 10.5 in. Shaft	295-310
Miyazaki Notched Speculum	250-250
Miyazaki DVD	337-221

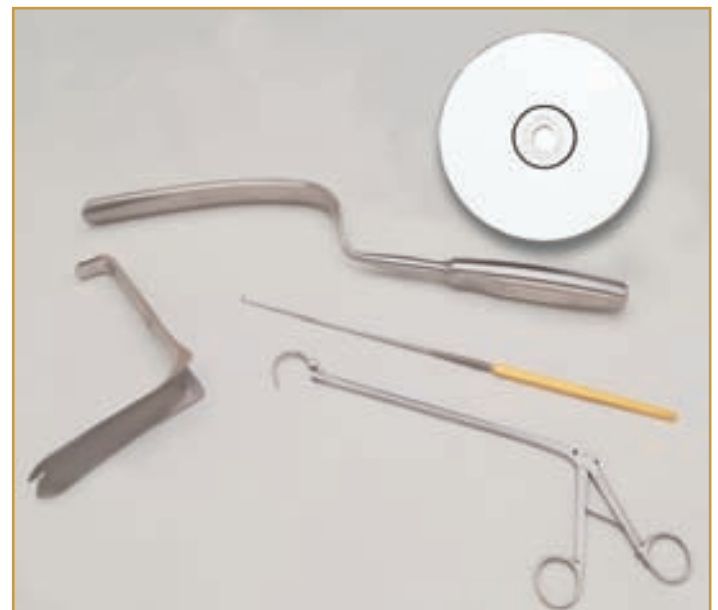

Designed and developed by Fred Miyazaki, M.D., Los Angeles, California



MINOR SURGERY SETS

Marina Medical offers a wide range of instruments used in minor surgeries performed in the office or hospital. Below are pictured the most popular items. (If you do not see your favorite item, please ask your rep for it.)



040-070

**#3
GRADUATED
HANDLE**

For blades #10-18
13.0 cm / 5.0 in.



040-090

**#7
HANDLE**

For blades #10-18
16.0 cm / 6.2 5in.



ADSON FORCEPS

Without teeth

Product Description	Product No.
Straight, Fine - 1.5 mm Tip - 12 cm / 4.75 in.	060-117
Standard - 2 mm Tip - 12 cm / 4.75 in.	060-120
Fenestrated Handle - 2 mm Tip - 12 cm / 4.75 in.	060-121
Straight - 2 mm Tip - 15 cm / 6 in.	060-125

With teeth

Product Description	Product No.
1 x 2 Teeth, Straight - 2 mm Tip - 12 cm / 4.75 in.	060-130
1 x 2 Teeth, Fenestrated Handle - 2 mm Tip - 12 cm / 4.75 in.	060-131
1 x 2 Teeth - 2 mm Tip - 15 cm / 6 in.	060-132
1 x 2 Teeth, Straight, Fine , 1.5 mm Tip - 12 cm / 4.75 in.	060-134
1 x 2 Teeth, Curved - 2 mm Tip - 12 cm / 4.75in	060-140
2 x 3 Teeth, Straight - 2 mm Smooth Tip - 12 cm / 4.75in.	060-150

MAYO-HEGAR NEEDLE HOLDERS

Prod. Description	Product No.
Stainless Steel	
15 cm / 6.0 in.	080-140
18 cm / 7.0 in.	080-160
20 cm / 8.0 in.	080-180
23 cm / 9.0 in.	080-200
26.5 cm / 10.5 in.	080-220
TC-Smooth	
18 cm / 7.0 in.	420-317
TC-Serrated	
14 cm / 5.5 in.	420-314
16 cm / 6.25 in.	420-316
18 cm / 7.0 in.	420-318
20 cm / 8.0 in.	420-320
23 cm / 9.0 in.	420-323
26.5 cm / 10.5 in.	420-326



Marina Cervical and Uterine Instruments

COHEN MARINA CANNULA / MANIPULATOR

- Comes complete with one small and one large cervical cone

Manipulator with Adapters	Replacement Small Cone	Replacement Large Cone
791-161	Z0000126450	Z0000126451





The New Wave in GYN

Marina Cervical and Uterine Instruments

MARINA UTERINE MANIPULATORS

A choice of three reusable Uterine Manipulators with malleable uterine sound and cervical tenaculum grasper.



Product Description

Tenaculum - Insulated, 9.5 in.
Tooth Tenaculum, 9.5 in.
Atraumatic Tenaculum, 9.5 in.

Product No.

340-201
340-203
340-209

MARINA UTERINE INJECTORS

A choice of two reusable Uterine Injectors with cervical acorn and tenaculum holders.



Product Description

Kahn Uterine Trigger Cannula, 10 in.
Jarco Self-retaining Cannula, 10 in.

Product No.

338-100
338-300

Ask for spare parts availability. Acorns available in rubber, nylon, or teflon.

This product is designed in the same overall style as the Valtchev and Pelosi manipulators (considered by many to be two of the best uterine manipulators designed.) Marina Medical offers the most ergonomically designed, comfortable, reusable manipulator yet... and you'll welcome the price improvement, too.

MARINA MANIPULATOR



Interchangeable
Obturator
and Cannulas

Product Description

Marina Manipulator, complete
Manipulator Body only, no tip ends
Injector, 3.2 mm x 34 mm
Injector, 3.2 mm x 45 mm
Injector, 3 mm x 45 mm
Manipulator, 3 mm x 55 mm
Manipulator, 8 mm x 80 mm
Manipulator, 10 mm x 100 mm

Product No.

340-210
340-211
340-212
340-213
340-214
340-215
340-216
340-217



Uterine Manipulators & Injectors



ZINNANTI ADJUSTABLE HANDLE MANIPULATOR (ZAMI 4.5)

Both Manipulators are Ideal for:

- Laparoscopy
- Minilaparotomy
- ZAMI 4.5 is latex free



ZINNANTI 4.5MM UTERINE MANIPULATOR

Both Manipulators feature:

- Sterile disposable Uterine Manipulators
- Minimal dilation
- Small diameter (4.5 mm) is less traumatic
- Anatomically correct, curved for easy insertion
- Ideal for anteverted and retroverted uterus
- Unique handles allow for easy viewing of cervical OS
- Built in injectors eliminate need for second instrument
- No need for tenaculum

Product Description

Zinnanti Adjustable* Uterine Manipulator (ZAMI), 4.5 mm, (Box of 12)

Product No.

MM-6003

Product Description

Zinnanti Uterine Manipulator, 4.5 mm, (Box of 12)

Product No.

MMI-611

*The pinch-grip handle facilitates easy adjustment for smooth insertion and repositioning for uterine length.

MARINA HSG-SONO CATHETER™

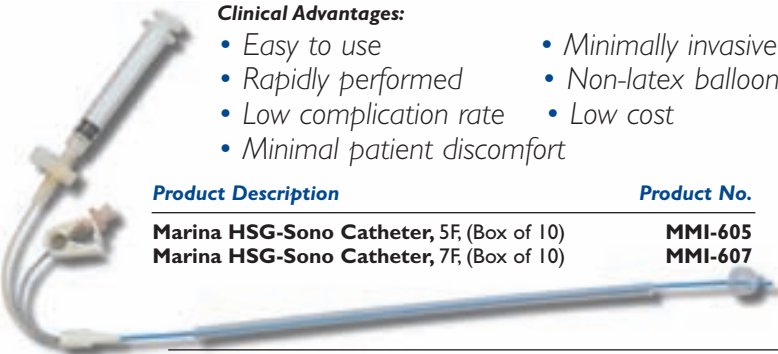

Clinical Advantages:

- Easy to use
- Rapidly performed
- Low complication rate
- Minimal patient discomfort
- Minimally invasive
- Non-latex balloon
- Low cost

Product Description

Marina HSG-Sono Catheter, 5F, (Box of 10)
Marina HSG-Sono Catheter, 7F, (Box of 10)

Product No.

MMI-605
MMI-607

ZUI™ UTERINE INJECTOR

Ideal for: • Hydrotubation • Salpingoplasty • Hysterosalpingography



Product Description

ZUI Uterine Injector, 2.0 mm, (Box of 12)
ZUI Uterine Injector, 4.0 mm, (Box of 12)

Product No.

MMI-610
MMI-609

THE CLEARVIEW



Product Description

The Clearview Uterine Manipulator (Box of 5)

Product No.

UM201



The New Wave in GYN

Custom - Deep MARINA SPECIALTY RETRACTORS

Deeper Blades - **Custom Made**

THE FOUR-ARMED BALFOUR RETRACTOR

Marina Medical offers the complete 4 Blade Balfour Retractor. A Balfour 4th Arm Extension (#110-435) allows excellent, non-interfering Anterior Blade Retraction during laparotomy.

Designed to work with almost all Balfour Retractors. Order the 4th Arm Extension separately or as part of a complete 4 Blade Balfour Retractor.



Product Description	Product No.
Balfour Retractor, 2 Sets Interchangeable Blades 5 cm / 2 in. deep and 10 cm / 4 in. deep, Spread 25 cm / 10 in.	110-432
Balfour 4th Arm Extension (R) w/ 2 in. x 7 in. Malleable Blade	110-435
Balfour 4th Arm Extension (L) w/ 2 in. x 7 in. Malleable Blade	110-437
Balfour Center Blade - 1 in. wide x 1 in. depth	110-438
Balfour Center Blade - 3 in. wide x 1.75 in. depth	110-440
Balfour Center Blade - 3.4 in. wide x 2.75 in. depth	110-441
Balfour Center Blade - 2.75 in. wide x 4 in. depth	110-442
Balfour Center Blade - 2 in. wide x 7 in. depth, Malleable	110-444

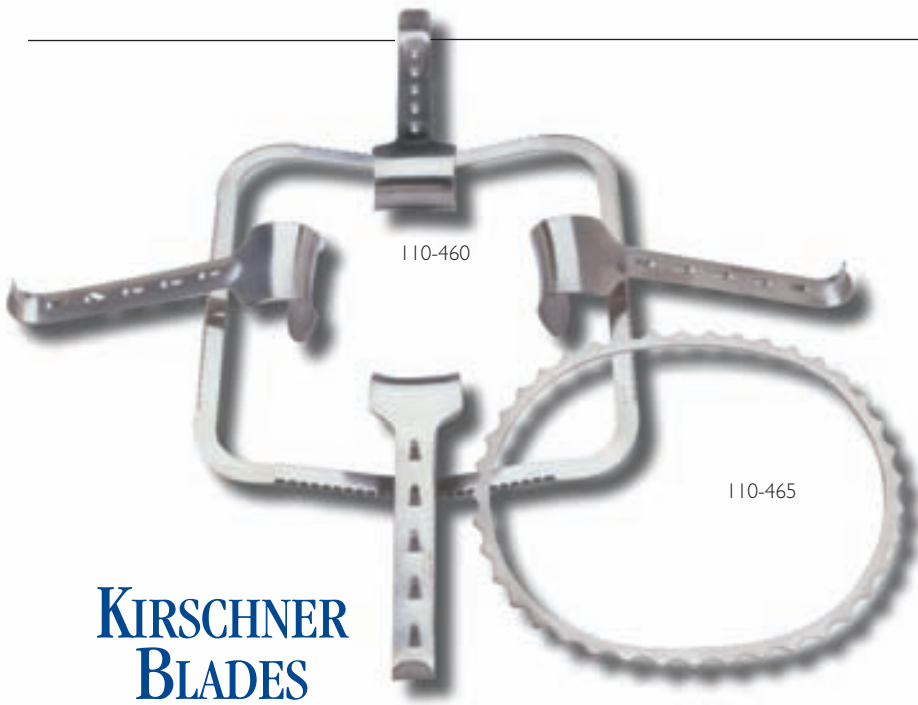

KIRSCHNER BLADES & FRAMES

The top choice for the Pfannenstiel Incision.

Product Description	Product No.
Kirschner Retractor Set, 10 in. x 10 in. frame complete with 4 blades, (2 ea. 110-462, 2 ea. 110-464)	110-460
Kirschner Oval Frame, 9.5 in. x 12 in.	110-465
Kirschner Blade, Medium Large, 60 mm x 85 mm	110-468
Kirschner Extra Deep, 78 mm x 65 mm	110-470
Kirschner Extra Large, 80 mm x 90 mm	110-472



DEEP PELVIC O'CONNOR-O'SULLIVAN **Customized** RETRACTORS

Marina offers the widest variety of O'Connor-O'Sullivan Retractors including customized deep lateral, anterior and posterior blades. Ask for the exact dimensions desired... we will deliver.



Product Description	Product No.
Complete retractor w/ 3 blades, 2 ea. 1.75 in. x 3.5 in., 1 ea. 2.75 in. x 4 in. Fixed lateral blades - 2 in. depth	110-450
Same, with fixed lateral blades - 3 in. depth	110-451
Blade, 1.75 in. x 3.25 in.	110-452
Blade, 2.75 in. x 4 in.	110-454
Blade, 1.75 in. x 5 in. (extra long)	110-456
Blade, 3.5 in. x 4.5 in. (extra large)	110-458
Blade, Short, Triangular	110-459

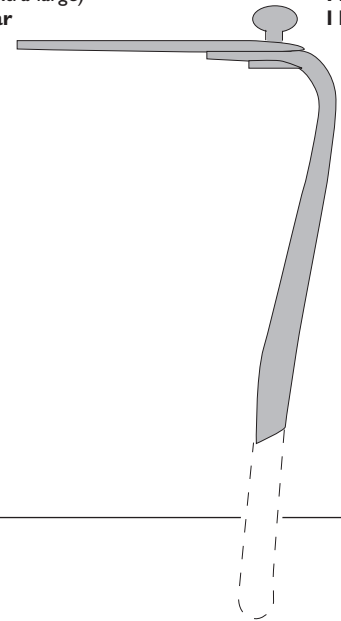

110-459



110-454



110-458



110-456



110-452

GUTTMAN SPECULA & RETRACTORS

Sturdy 3-Blade Vaginal Retractor

- Use either style for any procedure
- Wide retraction for surgical or OB procedures
- Easy to open and close
- No assembly required

Product Description	Product No.
---------------------	-------------

Guttman Vaginal Specula with Prongs	
Fenestrated Center Blade 3.5"	250-701
Solid Center Blade 3.5"	250-702

Guttman Surgical Retractor	
3" Blade	250-703
4.25" Blade	250-704



250-702



250-703



The Most Comprehensively Designed Surgical Retractor Available Today!

Ideal for the following surgeries: • General • Urology • Vaginal • Bariatric • Rectal • Pediatric

The Marina Medical Multiple Retractor Set (Marina Multi-Trac) has been designed to provide the flexibility necessary for the Operating Room. With almost twenty different ring possibilities and hundreds of retractor blade styles to choose from the **Multi-Trac** is suited for use in many different specialties and can be configured to fit the special needs of almost any patient.

- Sterilization Supplies
- Rings
- Table Mounting Components
- Retractor Blades
- Retractor Sets

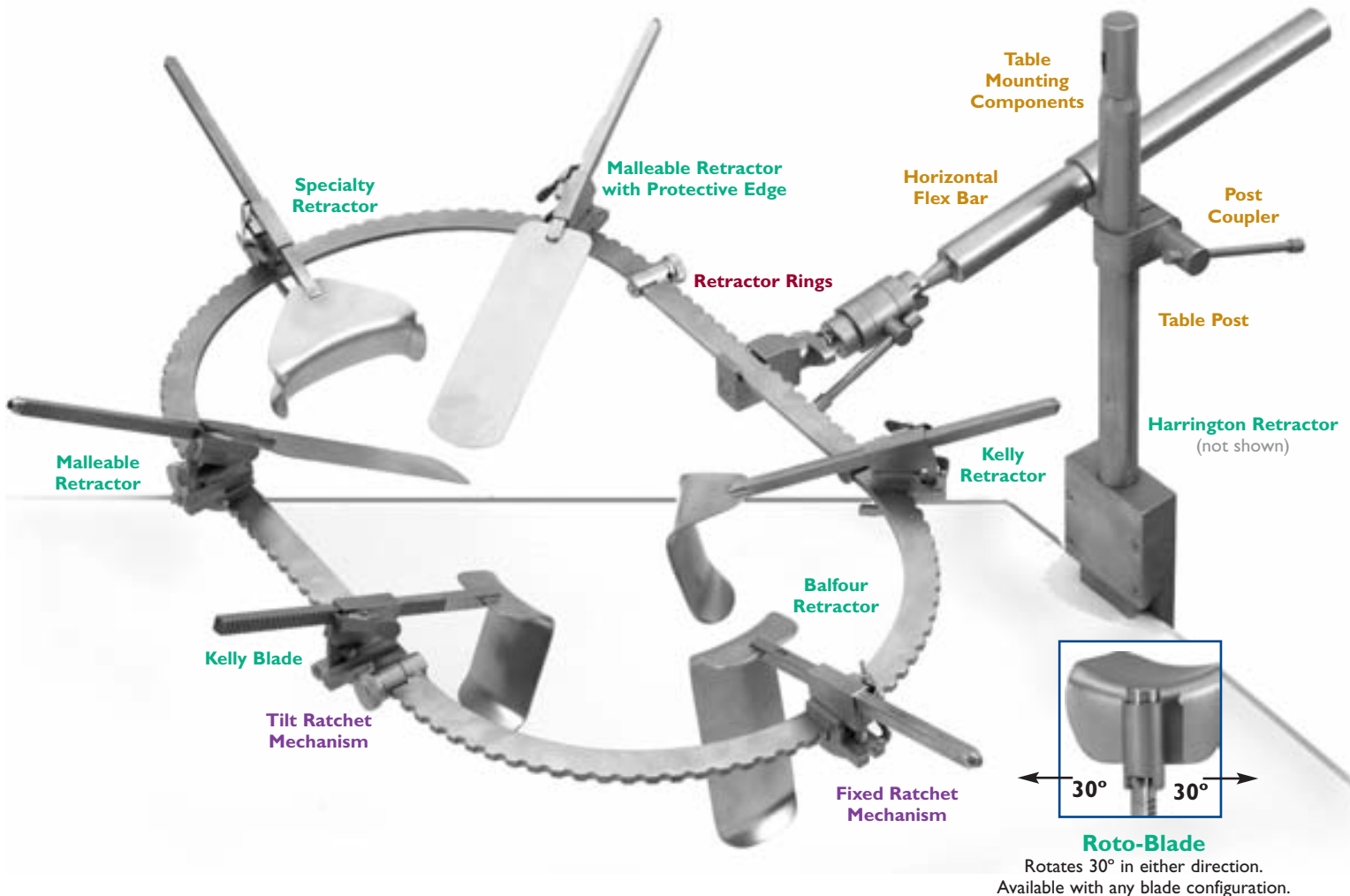

Roto-Blade
Rotates 30° in either direction.
Available with any blade configuration.



Sterilization Containers & Baskets



The many components of the **Multi-Trac Retractor Set** can all be neatly arranged into autoclave sized containers with diagrams that direct instrument handlers on proper placement of each component. A major convenience in care and maintenance of the Retractor Set.

Authorized Representative in European Community

CE REP: Medical Device Consultancy
 Address: 6 Bessborough Drive, Cardiff CF11 8NE, Wales, UK
 Phone: +44 (0) 29 2022 1640
 Cell: +44 (0) 77 3973 3177
 Web Site: www.medicaldeviceconsultancy.co.uk

Product Description

Product No.

Table Fixation & Ring Case
 Blades & Accessories Case

110-760
 110-770

Assembly Components

RINGS

Product Description

Dimension

Product No.

Round Ring, Small	8.5 in. I.D.	110-716A
Round Ring, Medium	10.5 in. I.D.	110-716B
Round Ring, Large	12.5 in. I.D.	110-716C
Oval Ring, Small	13.5 in. x 8.5 in.	110-716
Oval Ring, Medium	14.5 in. x 10.5 in.	110-717
Oval Ring, Large	18.5 in. x 12.0 in.	110-718
Segmented Ring, Medium	19.5 in. x 10.5 in.	110-731
Segmented Ring, Oval, Large	12.0 in. D Oval, 6 in. Segment	110-803A
Segmented Ring, Oval, Medium	10.0 in. D Oval, 8 in. Segment	110-803B
Segmented Ring, Oval, Small	8.0 in. D Oval, 4 in. Segment	110-803C
Segmented Ring, Round, Large	12.0 in.	110-803D
Segmented Ring, Round, Medium	10.0 in.	110-803E
Segmented Ring, Round, Small	8.0 in.	110-803F
Vaginal Retractor Ring	8.0 in. x 10.5 in.	110-917
Jordan-Simpson Retractor Ring, Segmented, Slotted	8.5 in. I.D.	110-861
Straight Segmented/Extension	4 in. (pair)	110-803G
Straight Segmented/Extension	6 in. (pair)	110-803H
Straight Segmented/Extension	8 in. (pair)	110-803I

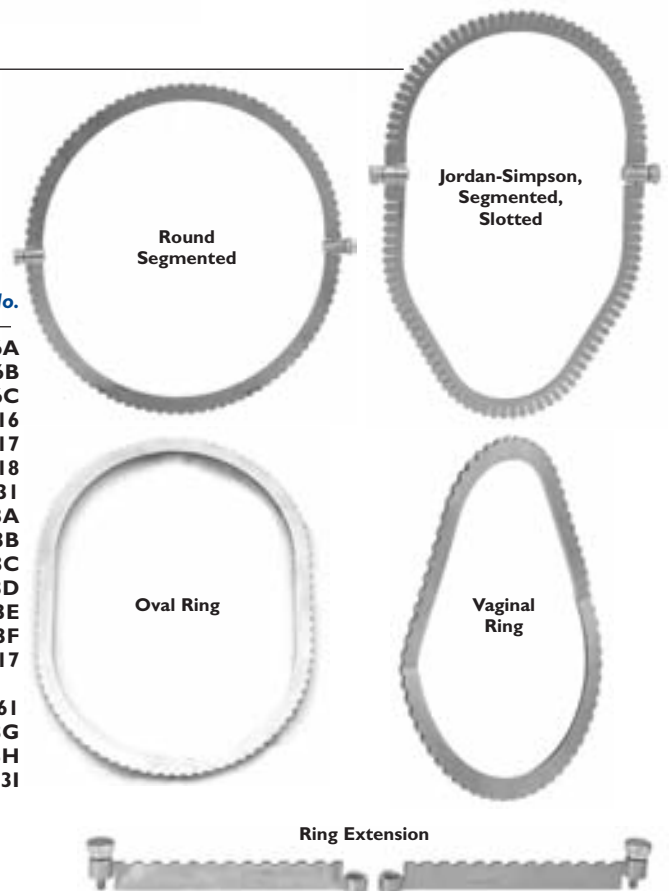



TABLE MOUNTING COMPONENTS

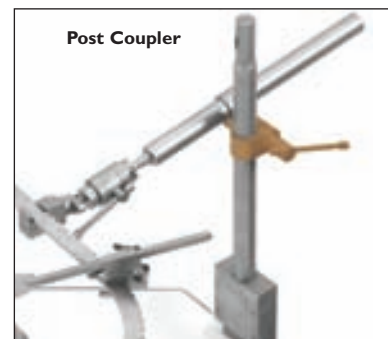
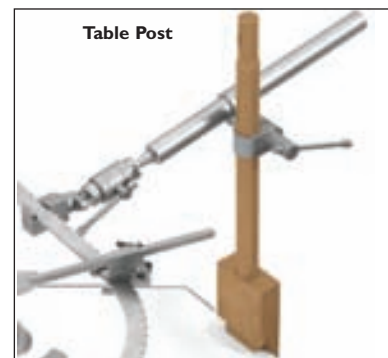

TABLE MOUNTING COMPONENTS

Product Description	Product No.
Post Coupler, 1 in.	110-715
Table Post, 1 in., Length: 18 in.	110-711
Table Post, 1 in., Length: 24 in.	110-711XL
Extension Bar (30.5 cm / 12 in.)	110-747
Horizontal Bar	110-713
Horizontal Flex Bar	110-741



FIXED RATCHET MECHANISM

Allows extension or retraction along the horizontal axis at 2 mm intervals.



TILT RATCHET MECHANISM

Allows extension or retraction along the horizontal axis and allows vertical movement of retractor blade with a second ratchet.

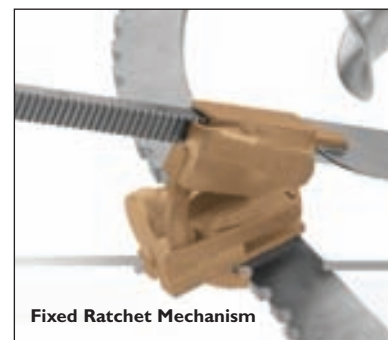
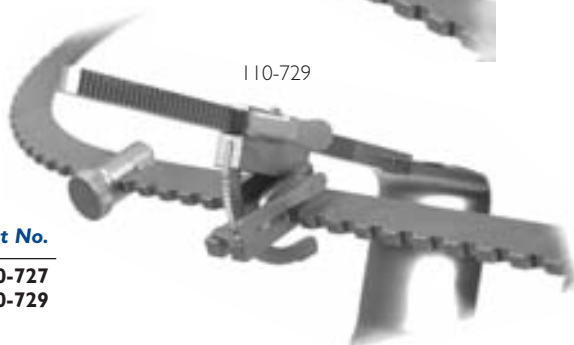

RATCHET MECHANISMS

Product Description	Product No.
Fixed Ratchet Mechanism	110-727
Tilt Ratchet Mechanism	110-729



MARINA MULTIPLE RETRACTORS

KELLY RETRACTOR BLADES

Product Description (Width x Length)

Product No.

Kelly Retractor , 1 in. x 1 1/2 in.	110-720
Kelly Retractor , 2 in. x 3 in.	110-721
Kelly Retractor , 2 in. x 4 in.	110-723
Kelly Retractor , 2 in. x 5 in.	110-737
Kelly Retractor , 3 in. x 2 5/8 in.	110-738
Kelly Retractor , 2 in. x 6 in.	110-739
Kelly Retractor , 2 5/8 in. x 3 in.	110-740
Kelly Retractor , 1 in. x 2 1/2 in.	110-742
Kelly Retractor , 2 in. x 7 in.	110-745
Kelly Retractor , 2 1/2 in. x 3 in.	110-834
Kelly Retractor , 2 in. x 2 in.	110-834A
Kelly Retractor , 2 1/2 in. x 7 in.	110-835
Kelly Retractor , 2 1/2 in. x 8 in.	110-836
Kelly Retractor , 2 in. x 8 in.	110-836A
Kelly Retractor , 2 1/2 in. x 10 in.	110-837
Jordan-Richardson-Simpson Retractor , 0.75 in. x 1 in.	110-877
Jordan-Richardson-Simpson Retractor , 0.75 in. x 2 in.	110-878
Jordan-Richardson-Simpson Retractor , 1 in. x 1.25 in.	110-879

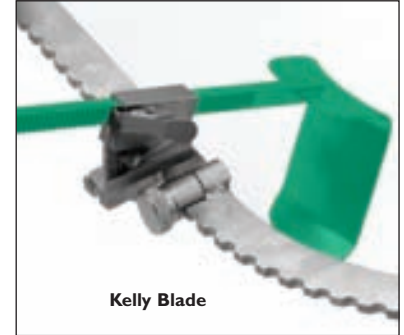

Add **R** to any blade for rotatable. Custom sizes available

MALLEABLE RETRACTOR BLADES

All retractors come with protective edges.

Product Description (Width x Length)

Product No.

Malleable Retractors , 2 in. x 6 in.	110-719
Malleable Retractor , 1 1/2 in. x 6 in.	110-733
Malleable Retractor , 3 in. x 6 in.	110-735
Malleable Retractor , 1 1/2 in. x 4 in.	110-805
Malleable Retractor , 1/2 in. x 3 in.	110-809
Malleable Retractor , 1 in. x 4 in.	110-810
Malleable Retractor , 1 in. x 5 in.	110-811
Malleable Retractor , 1 in. x 6 in.	110-812
Malleable Retractor , 6 in. x 12 in.	110-813
Malleable Retractor , 1 in. x 9 in.	110-814
Malleable Retractor , 2 in. x 7 in.	110-815
Malleable Retractor , 3 in. x 7 in.	110-816
Malleable Retractor , 2 in. x 9 in.	110-817
Malleable Retractor , 2 in. x 10 in.	110-817A
Malleable Retractor , 2 in. x 12 in.	110-818
Malleable Retractor , 3 in. x 10 in.	110-819
Malleable Retractor , 3 in. x 9 in.	110-819A
Malleable Retractor , 3 in. x 12 in.	110-820
Malleable Retractor , 4 in. x 10 in.	110-821
Malleable Retractor , 4 in. x 9 in.	110-822
Malleable Retractor , 4 in. x 10 in.	110-822A
Malleable Retractor , 6 in. x 12 in.	110-823
Malleable Retractor , 1/2 in. x 3 in.	110-848
Loughlin-Simpson Retractor , 3 1/2 cm x 10 cm	110-856
Loughlin-Simpson Retractor , 3 1/2 cm x 13 cm	110-857
Loughlin-Simpson Retractor , 3 1/2 cm x 15 cm	110-858



Add **R** to any blade for rotatable. Custom sizes available.



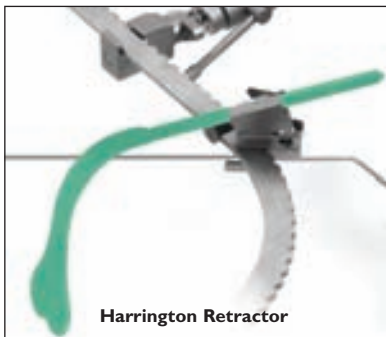

HARRINGTON RETRACTOR BLADES

Product Description	Product No.
Harrington Retractor, 2 1/2 in. x 5 1/4 in.	110-743
Baby Harrington Retractor, 1 1/2 in. x 5 in.	110-825
Harrington Retractor, 2 1/2 in. x 9 in.	110-826
Harrington Retractor, 3 1/2 in. x 10 in.	110-826A

Add **R** to any blade for rotatable.

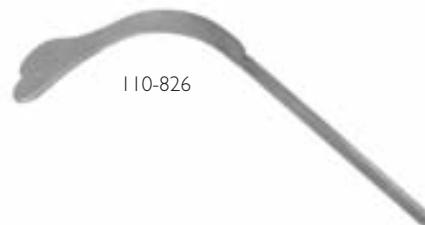

BALFOUR RETRACTOR BLADES

Product Description	Product No.
Balfour Retractor, 3 in. x 4 in.	110-724
Balfour Retractor, 3 3/8 in. x 2 3/4 in.	110-725
Balfour Retractor, 3 3/8 in. x 1 1/2 in.	110-725B
Balfour Retractor, 3 3/8 in. x 4 in.	110-725C
Balfour Blade Retractor, 4 in. x 3 3/4 in.	110-827
Goulet-Simpson Retractor, Small 1 in.	110-867
Goulet-Simpson Retractor, Large 1 1/2 in.	110-868

Add **R** to any blade for rotatable.

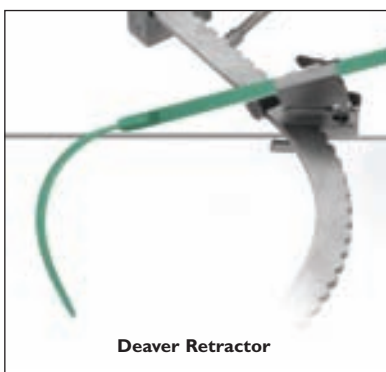

DEAVER RETRACTOR BLADES

Product Description	Product No.
Deaver Blade, Small, 1 in. x 3.5 in.	110-921
Deaver Blade, Large, 1 in. x 7 in.	110-922
Deaver Blade, Large, 1 in. x 5 in.	110-923
Deaver Blade, Large, 2 in. x 5 in.	110-924

Add **R** to any blade for rotatable.



MARINA LIVER RETRACTORS

Our **Marina Liver Retractors** offer the flexibility and usability that doctors demand. Light weight, solid construction and maximum visibility to ensure proper retraction of the liver with even weight distribution.

Product Description	Product No.
<i>Flat Handle for the Martin's Arm and Multi-Trac Systems, 5mm</i>	
Pediatric	CS1000-850
Small	CS1000-851
Medium	CS1000-852
Medium / Large	CS1000-853
Large	CS1000-854
<i>Round Handle for the Iron Intern</i>	
Large, 3 mm	CS69705
Medium / Large, 3 mm	CS69706
Medium, 5 mm	CS69707
Large, 5 mm	CS69708
Medium / Large, 5 mm	CS69709





SPECIALTY UROLOGICAL RETRACTOR BLADES



Product Description	Product No.
Yu-Holtgrewe Malleable Retractor w/ Simpson Handle 2 1/2 in. x 7 in.	110-840
Carroll Prostatic Retractor w/ Simpson Handle 1 1/2 in. wide spreads to 3 1/4 in. x 7 in.	110-843
Single Hook Malleable Retractor w/ Ball Probe and Simpson Handle	110-845
Double Hook Malleable Retractor w/ Ball Probe and Simpson Handle, 8 mm	110-846



GENERAL SURGERY & DEEP PELVIC RETRACTORS

Product Description	Product No.
Gelpi Retractor	110-746
Simpson-St. Mark's Retractor, 5 in. w/ Lip	110-870
Simpson-St. Mark's Retractor, 6 in. w/ Lip	110-871
Simpson-St. Mark's Retractor, 7 in. w/ Lip	110-872
Simpson-St. Mark's Retractor, 7 in. w/ Lip, Angled 15°	110-976
Simpson-St. Mark's Retractor, 7 in. Narrow w/ Lip	110-975
Simpson-St. Mark's Retractor, 9 in. w/ Lip	110-977
Simpson-St. Mark's Retractor, 9 in. w/ Lip, Angled 15°	110-978
Simpson-Wylie Vein Retractor, 1 in. x 5 in.	110-873
Simpson-Wylie Vein Retractor, 1 in. x 6 in.	110-874
Simpson-Wylie Vein Retractor, 1 in. x 7 in.	110-875
Simpson-Wylie Vein Retractor, 1 in. x 9 in.	110-876
Simpson-Wylie Radiolucent Vein Retractor, 1 in. x 5 in.	110-873RA
Simpson-Wylie Aluminum Radiolucent Vein Retractor, 1 in. x 6 in.	110-874RA
Simpson-Wylie Aluminum Radiolucent Vein Retractor, 1 in. x 7 in.	110-875RA
Simpson-Wylie Radiolucent Vein Retractor, 1 in. x 9 in.	110-876RA
Simpson-Murphy Gall Bladder Retractor, 2 in. wide	110-980



Add **R** to any blade for rotatable.

STERILIZATION SUPPLIES

INTERNAL INDICATOR STRIPS

Product Description	Product No.
4 1/4 in. W x 1 11/16 in. L, 250 per case	CA2010

PULL TIGHT™ LOCKS

A plastic seal that fits through the channel on the locking pin and locks. Must be broken to open container.

Product Description	Product No.
White, without indicator, 100 per case	CA1034

STERILIZATION FILTERS

Disposable Sterisheet™, natural, 100% cellulose material, water repellent. (For both EtO and Steam cycles).

Product Description	Product No.
9.5 in. x 9.5 in., without indicator, 1,000 per case	CA3001



MARINA RETRACTOR SETS

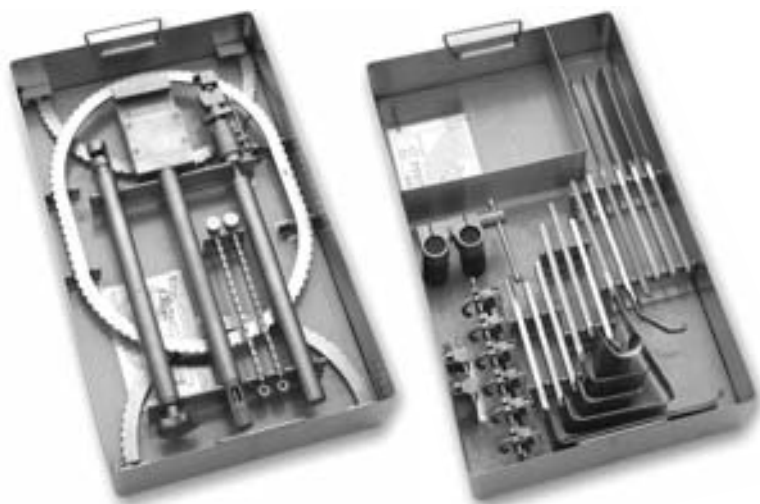

MARINA MULTI-TRAC RETRACTOR SET

Product Description	Product No.
Table Post, 1 in., Length: 18 in.	110-711
Horizontal Flex Bar	110-741
Horizontal Bar	110-713
Post Coupling, 1 in.	110-715
Medium Oval Ring, (14 1/2 in. x 10 1/2 in.)	110-717
Segmented Ring, (49 1/2 cm x 26 1/2 cm / 19 1/2 in. x 10 1/2 in.)	110-731
Ratchet Mechanisms, (2)	110-727
Tilt Ratchet Mechanisms, (6)	110-729
Kelly Retractors, (2), 2 in. x 3 in.	110-721
Kelly Retractors, 2 in. x 4 in.	110-723
Kelly Retractor, 2 in. x 5 in.	110-737
Kelly Retractor, 2 in. x 6 in.	110-739
Balfour Retractor, 3 3/8 in. x 2 3/4 in.	110-725
Malleable Retractor, 1 1/2 in. x 6 in.	110-733
Malleable Retractors, (2), 2 in. x 6 in.	110-719
Malleable Retractor, 3 in. x 6 in.	110-735
Harrington Retractor, 2 1/2 in. x 5 1/4 in.	110-743
Gelpi Retractor	110-746
<i>Accessories</i>	
Table Fixation & Ring Case	110-760
Blades & Accessories Case	110-770

MARINA VAGINAL MULTI-TRAC RETRACTOR SET

Product Description	Product No.
Vaginal Retractor Ring, 8 in. x 10 1/2 in.	110-917
Posterior Blade, 1 in. x 4.5 in.	110-925
Lateral Retractor Blade, 1 in. x 3 in.	110-919
Deaver Blade, Small, 1 in. x 3 1/2 in.	110-921
Deaver Blade, Large, 1 in. x 5 in.	110-923
<i>Other blades useful for vaginal surgery:</i>	
Malleable Retractor w/ Protective Edge, 1 in. x 5 in.	110-811
Malleable Retractor w/ Protective Edge, 1 in. x 6 in.	110-812
Malleable Retractor w/ Lip, 1/2 in. x 3 in.	110-848
Malleable Retractor w/ Protective Edge, 1 in. x 4 in.	110-810
Malleable Retractor w/ Protective Edge, 1.5 in. x 4 in.	110-805
Single Hook Malleable Retractor w/ Ball Probe, and Simpson Handle	110-845
Double Hook Malleable Retractor w/ Ball Probe and Simpson Handle, 8 mm	110-846

MARINA BARIATRIC MULTI-TRAC RETRACTOR SET

Product Description	Product No.
Table Post, 1 in., Length: 18 in.	110-711
Horizontal Bar	110-713
1" Post Coupling	110-715
Horizontal Flex Bar	110-741
Medium Oval Ring, 14 1/2 in. x 10.5 in.	110-717
Vertical Extension Bar, 30 1/2 cm / 12 in.	110-747
Malleable Retractor w/ Protective Edge, 2 in. x 10 in.	110-817A
Malleable Retractor w/ Protective Edge, 3 in. x 10 in.	110-819
Malleable Retractor w/ Protective Edge, 4 in. x 10 in.	110-822A
Kelly Retractor, 2 in. x 3 in.	110-721
Kelly Retractor, 2 in. x 4 in.	110-723
Kelly Retractor, 2 in. x 8 in.	110-836A
Balfour Blade Retractor, 4 in. x 3 3/4 in.	110-827
Harrington Retractor, 3 1/2 in. x 10 in.	110-826A
<i>Optional:</i>	
Exchange 24" Table Post for 18" Table Post	110-711XL





Jordan-Simpson Perineal Set

JORDAN-SIMPSON PERINEAL RETRACTOR SET

<i>Product Description</i>	<i>Product No.</i>
Jordan-Simpson Segmented Retractor Ring, Slotted	110-861
Jordan-Simpson 3 Prong Retractor w/ Rotational Handle	110-862
Jordan-Simpson 4 Prong Retractor w/ Rotational Handle	110-863
Jordan-Simpson Right Angled Retractor, 1 in.	110-864
Jordan-Simpson Right Angled Retractor, 1 1/2 in.	110-865
Jordan-Richardson-Simpson Retractor, 1 in. x 1 1/2 in.	110-866
Goulet-Simpson Retractor, Small, 1 in.	110-867



Walther-Simpson Perineal Set

WALTHER-SIMPSON PERINEAL RETRACTOR SET

<i>Product Description</i>	<i>Product No.</i>
Jordan-Simpson Segmented Retractor Ring, Slotted, 8.5. in inner diameter	110-861
Malleable Retractor, w/ Protective Edge, 1 in. x 4 in., (2)	110-810
Malleable Retractor, w/ Protective Edge, 1 1/2 in. x 4 in.	110-805
Walther-Simpson Notched Retractor, 1 1/2 in. x 4 in.	110-854



Marina Rectal Multi-Trac Retractor Set

MARINA RECTAL MULTI-TRAC RETRACTOR SET

<i>Product Description</i>	<i>Product No.</i>
Rectal Ring , Round, Slotted, 8 1/2" Diameter	110-881
Fenestrated Rectal Blade, Angled, 7 cm	110-882
Solid Rectal Blade, Angled, w/Teeth, 7 cm	110-883



MARINA MEDICAL ENDOMETRIAL SAMPLERS



BUY A BOX AND GET SIX FINDERS FREE!

MAS!™ PACK

(Marina Ampler Sampler) (280-725)

Including Disposable Canal Finder

Marina Ampler Sampler provides optimal endometrial sample recovery while maintaining patient safety and comfort.

*Disposable Os Finder provides quick and easy dilation of the cervical os when necessary before the curette enters the cervix.
Box of 25.*

6 FREE Os Finders with every box of 25 Samplers.

Disposable Canal Finder available in boxes of 50 (see page 34).

MAS! with SYRINGE PACK

(Marina Ampler Sampler with Syringe)™

(280-655)

*Marina Ampler Sampler with Syringe with a Randall-like cutting edge and a syringe that provides extra vacuum and suction with a quick turn lock to prevent uterine reflux.
Box of 25.*



REUSABLE OS FINDER SET

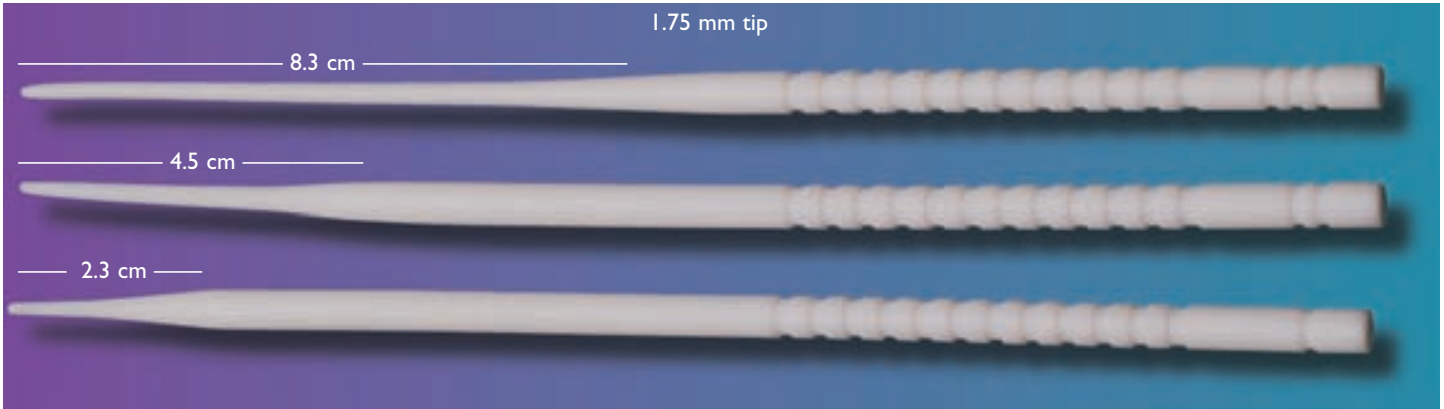

- Excellent for treatment of post menopausal patients with stenosis
- Excellent for endometrial or hysteroscopic procedures
- Gentle and forgiving during cervical canal dilation

Product No. 260-600

Fundus Finder, 8.5 in. Product No. 260-601

Opens the internal OS and sounds the fundus.

OS Finder, 8.5 in. 260-602

Finds and opens the external OS by tracking the narrow end against the cervix.

Canal Finder, 8.5 in. Product No. 260-603

Gently dilates the natural path of the cervical canal.



- Packed individually, sterile
- Convenient for immediate use
- 8.5 in.

DISPOSABLE CANAL FINDER



Product Description

Disposable Canal Finder, 8.5 in.
Sterile, box of 50

Product No.

260-610

(6 each at no charge in every box of endometrial samplers.
To order, see page 33)

NEW 4-BLADED VAGINAL SPECULUM



Stainless Steel



- One instrument... four blades
- No need to combine instruments
- Available in stainless steel or coated

Product Description

4-Sided Speculum, Pederson, Medium
4-Sided Speculum, Pederson, Large

Product No.

250-625
250-626



Non-Conductive Coating

Product Description

4-Sided N/C Speculum, Pederson, Medium
4-Sided N/C Speculum, Pederson, Large

Product No.

310-608
310-609



MARINA VAGINAL SPECULA

CLINTON Extra-Long Vaginal Speculum

Product Description *Blade Size* *Product No.*

GRAVES

Small	3 in. x .75 in.	250-301
Medium	4 in. x 1.5 in.	250-302
Large	4.75 in. x 1.5 in.	250-303
Clinton Graves Style	6 in. x 1.5 in.	250-602
Vu-Mar Graves, Small	3.5 in. x 1 in.	250-400
Vu-Mar Graves, Medium	4 in. x 1.5 in.	250-401
Vu-Mar Graves, Large	4.75 in. x 1.5 in.	250-402
XL Graves, Medium	4 in. x 1.5 in.	250-403
XL Graves, Large	4.75 in. x 1.5 in.	250-404
XXL Graves Style	7 in. x 1.75 in.	250-605

PEDERSON

Virginal	3 in. x .5 in.	250-501
Medium	4 in. x 7/8 in.	250-502
Large	4.5 in. x 1 in.	250-503
X-Narrow	4.5 in. x .5 in.	250-504
Clinton Pederson Style	6 in. x 1 in.	250-603
XL Pederson, Medium	4 in. x 1 in.	250-413
XL Pederson, Large	4.5 in. x 1 in.	250-414

MOORE-GRAVES

Medium	3.25 in. x 1.5 in.	250-306
--------	--------------------	---------

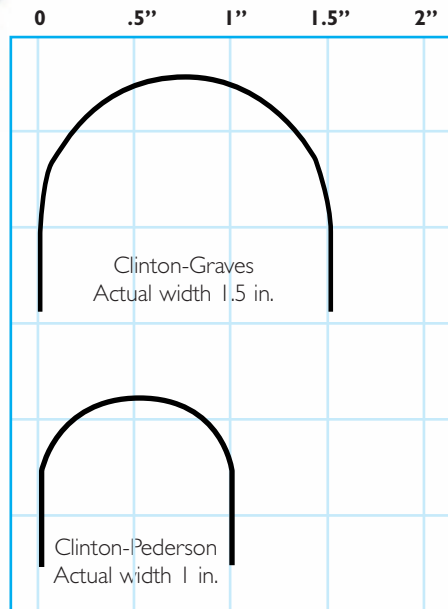
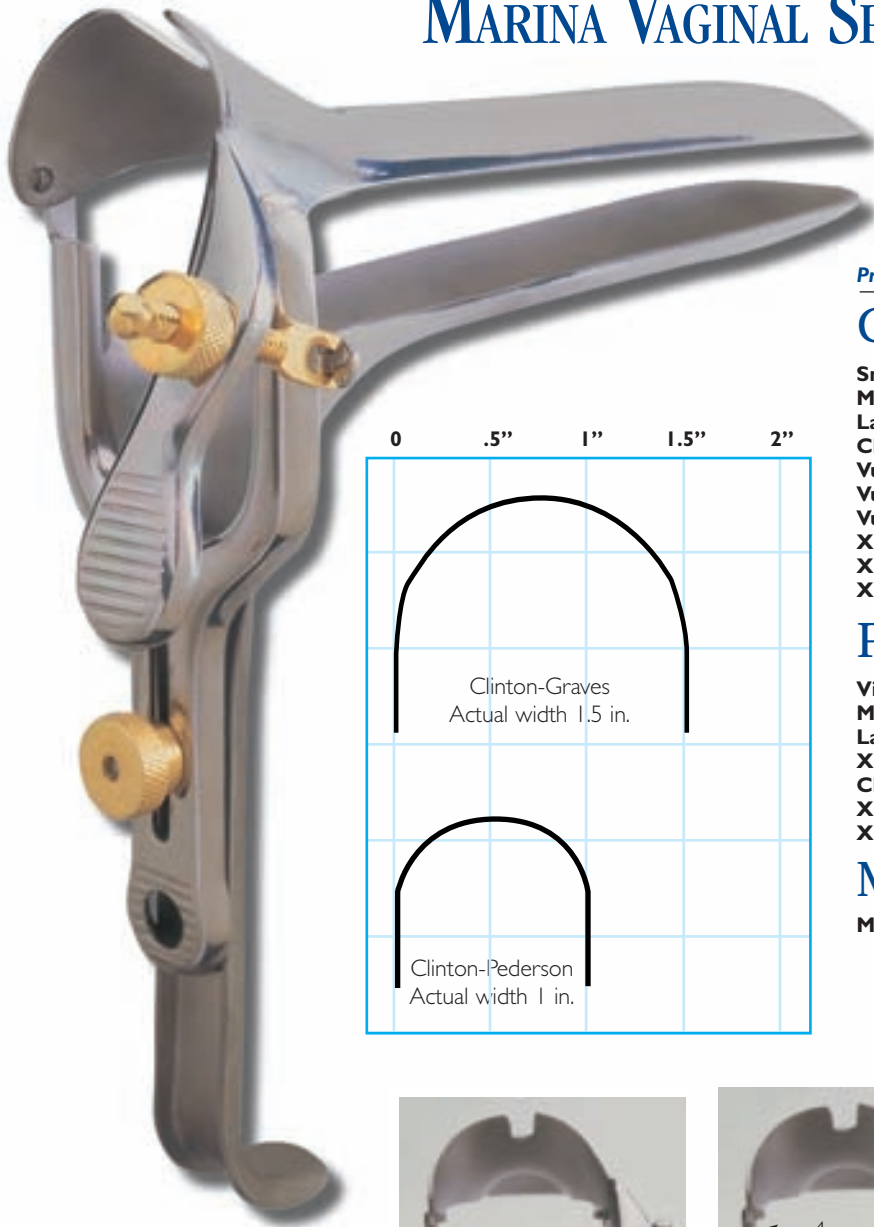

Normal, Wide & Wider

- Vu-Mar specula help visibility and instrument maneuvering
- Allow greater access at proximal end of speculum without decreasing patient comfort



Vu-Mar XL features four choices of blades.



Weisman-Pederson

Weisman-Graves

Open-Sided MARINA WEISMAN SPECULA

- The open-sided specula with the narrow Pederson blade — allows easy entrance and exit of auxiliary instruments
- Ideal for nulliparous or menopausal patients
- Extra-narrow blades available on request

Weisman Open-Sided

Product Dimension	Product No.
Graves, Large, Left, 4.75 in. x 1.5 in.	250-101
Graves, Medium, Left, 4 in. x 1.5 in.	250-102
Graves, Large, Right, 4.75 in. x 1.5 in.	250-103
Graves, Medium, Right, 4 in. x 1.5 in.	250-104
Clinton-Graves, Right Open, 6 in. x 1.5 in.	250-604
Clinton-Graves, Left Open, 6 in. x 1.5 in.	250-606
Clinton-Pederson Right Open, 6 in. x 1 in.	250-609
Pederson, Narrow, Right Open, 4 in. x 1 in.	250-111
Weisman-Graves, Left Open, XXL, 7 in.	250-607
Weisman-Graves, Right Open, XXL, 7 in.	250-608

MARINA SIDE WALL RETRACTORS

- For redundant vaginal wall retraction
 - Major selection of style and blade length
 - All German stainless steel

LATERAL WALL RETRACTORS (OPEN SHANKS)

(Use inside Graves or Pederson Speculum)

Product Description	Product No.
Open Shanks, 2.5 in. blades	250-610
Open Shanks, 3.5 in. blades	250-612
Open Shanks, 4.5 in. blades	250-614



LATERAL WALL RETRACTORS (CLOSED SHANKS)

(Use inside Graves or Pederson Speculum)

Product Description	Product No.
Closed Shanks, 2.5 in. blades	250-611



REDUNDANT WALL RETRACTOR

(Use outside Graves or Pederson Speculum)

Product Description	Product No.
Rigby Blades, 3.5 in.	250-619
Rigby Blades, 5 in.	250-620



DISPOSABLE SPECULA



250-104D



250-901L



250-901

Product Description

Open Side Speculum, Disposable (without light) - Box of 24
Open Side Speculum, Disposable, with Light - Box of 24

Disposable Vaginal Speculum - Small: 8.5 cm x 2 cm / 3.25 in x .75 in
Disposable Vaginal Speculum with Light - Small: 8.5 cm x 2 cm / 3.25 in x .75 in

Disposable Vaginal Speculum - Medium: 10 cm x 2.5 cm / 4 in x 1 in
Disposable Vaginal Speculum with Light - Medium: 10 cm x 2.5 cm / 4 in x 1 in

Disposable Vaginal Speculum - Large: 10 cm x 3 cm / 4 in x 1.25 in
Disposable Vaginal Speculum with Light - Large: 10 cm x 3 cm / 4 in x 1.25 in

Product No.

250-104D
250-104DL

250-901
250-901L

250-902
250-902L

250-903
250-903L

VERONIKIS VAGINAL DILATOR SETS™

- Minimal components for maximum combinations
- Unique thread design permits infinite length adjustment
- Easy for patients to self administer therapy, no bicycle seat required



3cm Tip 5cm Tip 7cm Tip Coupler Large Base Full Base 1cm Spacer 1cm Spacer

VVD™ Set (Veronikis Vaginal Dilator Set) For the Post-Surgical Vagina

- Features 1" (2.5 cm) width
- Dilator length from 3 cm to 16 cm

Product Description

VVD Set

Product No.

270-000



1.5cm Tip 2.5cm Tip 3.5cm Tip 4.5cm Tip 5.5cm Tip Full Taper Coupler Partial Taper Coupler Coupler-Extender Small Base Large Base

VNVD™ Set (Veronikis Vaginal Dilator Set) For the Non-Surgical Neo Vagina

- Features .625 in. (1.6 cm) width
- Dilator length from 1.5 cm to 12.5 cm
- Tapered couplers allow conversion to 1 in. (2.5 cm) width

Product Description

VNVD Set

Product No.

270-100





MORE DILATOR SETS

HEGAR DILATORS

Single Ended

Size	Product No.
1 mm	260-151
1.5 mm	260-152
2 mm	260-153
2.5 mm	260-154
3 mm	260-155
3.5 mm	260-156
4 mm	260-157
4.5 mm	260-158
5 mm	260-159
5.5 mm	260-160
6 mm	260-161
6.5 mm	260-162
7 mm	260-163
7.5 mm	260-164
8 mm	260-165
8.5 mm	260-166
9 mm	260-167
9.5 mm	260-168

Set of 11, 1-6 mm,
5 mm intervals
260-150

HEGAR DILATORS

Double Ended

Size	Product No.
1/2 mm: 19 cm / 7 1/2 in.	260-101
3/4 mm: 19 cm / 7 1/2 in.	260-103
5/6 mm: 19 cm / 7 1/2 in.	260-105
7/8 mm: 19 cm / 7 1/2 in.	260-107
9/10 mm: 19 cm / 7 1/2 in.	260-109
11/12 mm: 19 cm / 7 1/2 in.	260-111
13/14 mm: 19 cm / 7 1/2 in.	260-113
15/16 mm: 19 cm / 7 1/2 in.	260-115
17/18 mm: 19 cm / 7 1/2 in.	260-117
19/20 mm: 19 cm / 7 1/2 in.	260-119
21/22 mm: 19 cm / 7 1/2 in.	260-121
23/24 mm: 19 cm / 7 1/2 in.	260-123
25/26 mm: 19 cm / 7 1/2 in.	260-125

Set of 8, 3/4 mm - 17/18 mm
260-100

PRATT DILATORS

Double Ended

Size	Product No.
13/15 Fr., 29 cm / 11 1/2 in.	260-313
17/19 Fr., 29 cm / 11 1/2 in.	260-317
21/23 Fr., 29 cm / 11 1/2 in.	260-321
25/27 Fr., 29 cm / 11 1/2 in.	260-325
29/31 Fr., 29 cm / 11 1/2 in.	260-329
33/35 Fr., 29 cm / 11 1/2 in.	260-333
37/39 Fr., 29 cm / 11 1/2 in.	260-337
41/43 Fr., 29 cm / 11 1/2 in.	260-341
45/47 Fr., 29 cm / 11 1/2 in.	260-345
49/51 Fr., 29 cm / 11 1/2 in.	260-349
53/55 Fr., 29 cm / 11 1/2 in.	260-353
57/59 Fr., 29 cm / 11 1/2 in.	260-357
61/63 Fr., 29 cm / 11 1/2 in.	260-361
65/67 Fr., 29 cm / 11 1/2 in.	260-362
69/71 Fr., 29 cm / 11 1/2 in.	260-363
73/75 Fr., 29 cm / 11 1/2 in.	260-364
77/79 Fr., 29 cm / 11 1/2 in.	260-365

Set of 8, 13/15 - 41/43 Fr.
260-300

HANK DILATORS

Double Ended

Size	Product No.
5 / 6 fr / 26 cm / 10 1/4 in.	260-205
7 / 8 fr / 26 cm / 10 1/4 in.	260-207
9 / 10 fr / 26 cm / 10 1/4 in.	260-209
11 / 12 fr / 26 cm / 10 1/4 in.	260-211
13 / 14 fr / 26 cm / 10 1/4 in.	260-213
15 / 16 fr / 26 cm / 10 1/4 in.	260-215
17 / 18 fr / 26 cm / 10 1/4 in.	260-217
19 / 20 fr / 26 cm / 10 1/4 in.	260-219
21 / 22 fr / 26 cm / 10 1/4 in.	260-221
23 / 24 fr / 26 cm / 10 1/4 in.	260-223
25 / 26 fr / 26 cm / 10 1/4 in.	260-225
27 / 28 fr / 26 cm / 10 1/4 in.	260-227
29 / 30 fr / 26 cm / 10 1/4 in.	260-229

Set of 6,
9 fr - 20 fr
260-200

MINI CERVICAL DILATOR SET

Set includes:
Handle and Dilators, 1 mm - 3 mm,
Half sizes, custom pouch
260-020



MARINA BIOPSY PUNCHES

Produced with the highest quality German stainless steel to Marina specifications. A selection of the most popular Biopsy Punch Tips.

Standard Style

Roto-Fit Rotatable Style

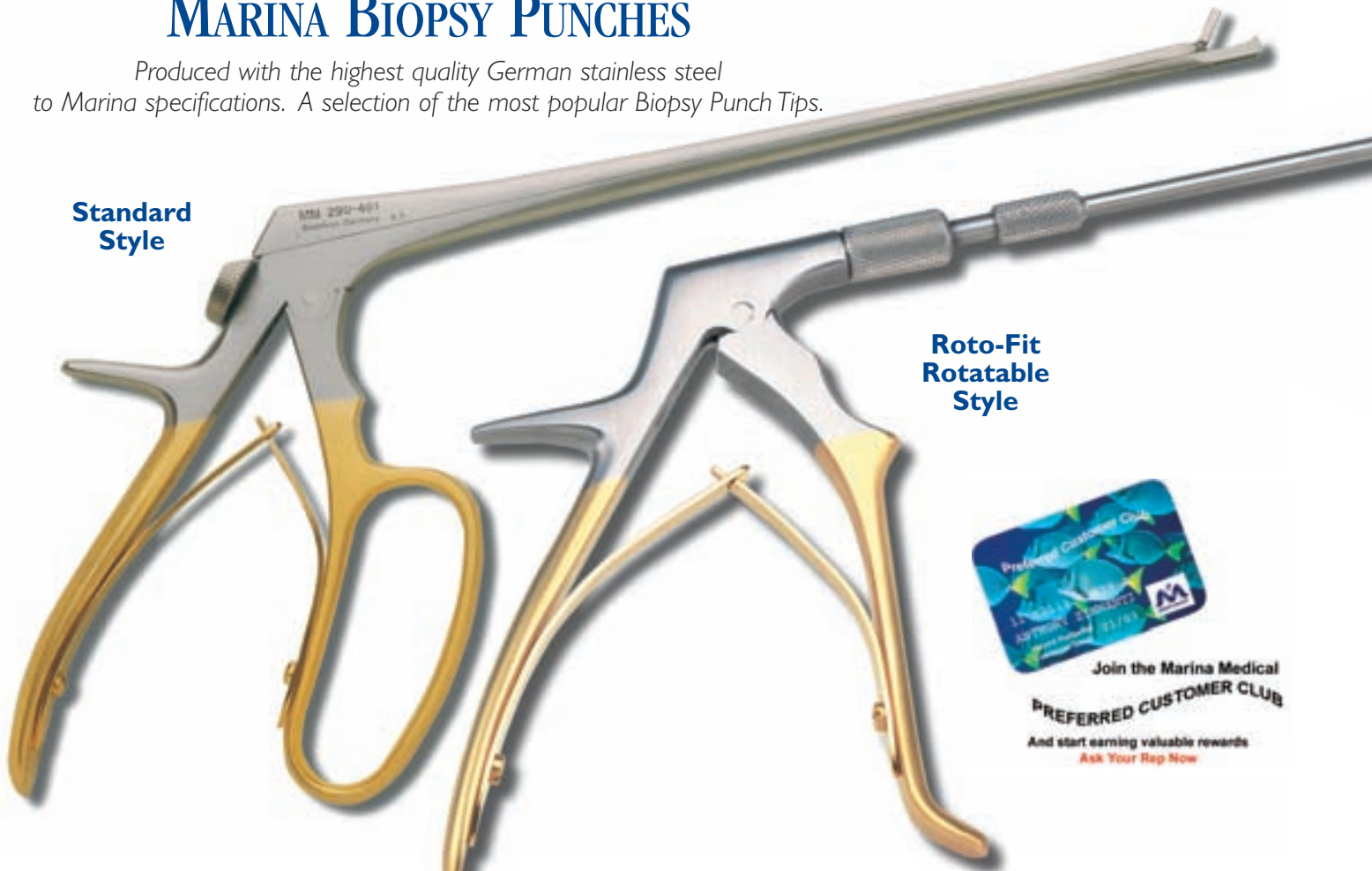

Join the Marina Medical
PREFERRED CUSTOMER CLUB
And start earning valuable rewards
Ask Your Rep Now



3 x 7mm bite.



2 x 4mm bite.

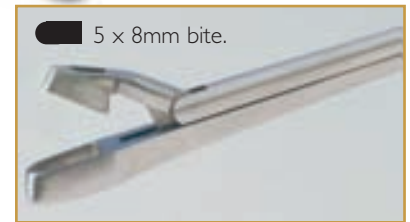

5 x 8mm bite.

Tischler

Product Description	Product No.
8 in. Shaft	290-208
10 in. Shaft	290-210
11 in. Roto Fit Shaft	290-212

Baby Tischler

Product Description	Product No.
8 in. Shaft	290-308
10 in. Shaft	290-310
11 in. Roto Fit Shaft	290-312

Eppendorfer

Product Description	Product No.
9 in. Shaft	290-509
11 in. Roto Fit Shaft	290-512



3 x 7mm bite.



3 x 6mm bite.



4 x 8mm bite.

Burke Style

Product Description	Product No.
8 in. Open Spring Handle	290-101

Kevorkian

Product Description	Product No.
8 in. Shaft	290-401
10 in. Shaft	290-402
11 in. Roto Fit Shaft	290-404

Wittner

Product Description	Product No.
9 in., Straight	290-601
9 in., Curved	290-602



Colposcopy Instruments

KOGAN ENDOCERVICAL SPECULA **Choice!**

Endocervical specula with narrow or standard blades.
Ratchet or screw-lock mechanism available.



**Set Screw-Lock
Mechanism**

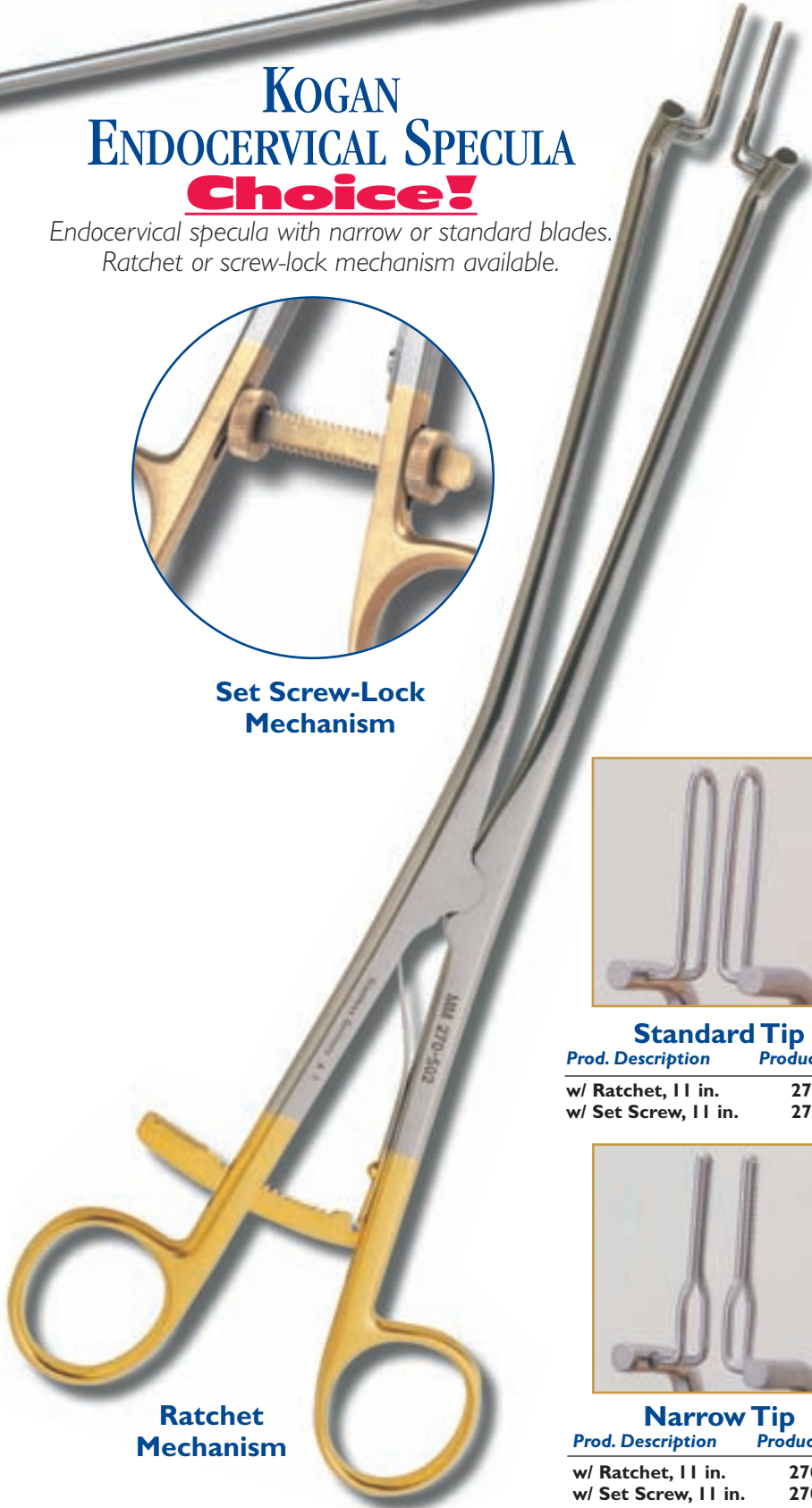

**Ratchet
Mechanism**



Standard Tip

Prod. Description	Product No.
w/ Ratchet, 11 in.	270-501
w/ Set Screw, 11 in.	270-509



Narrow Tip

Prod. Description	Product No.
w/ Ratchet, 11 in.	270-502
w/ Set Screw, 11 in.	270-512

MARINA ENDOCERVICAL CURETTES

A wide variety of endocervical
curettes with malleable or
rigid shaft.



Kevorkian Curette w/ Basket

Prod. Description	Product No.
11 3/4 in., Rigid	280-501
11 3/4 in., Malleable	280-504



Kevorkian Curette w/o Basket

Prod. Description	Product No.
11 3/4 in., Rigid	280-502
Mini Style, Rigid	280-503
11 3/4 in., Malleable	280-505



Heaney Curette

Prod. Description	Product No.
9 1/2 in., Malleable	280-401
9 1/2 in., Malleable w/ Basket	280-403



MARINA MYOMA GRASPING FORCEPS

For transcervical management of polyps and pedunculated myoma.

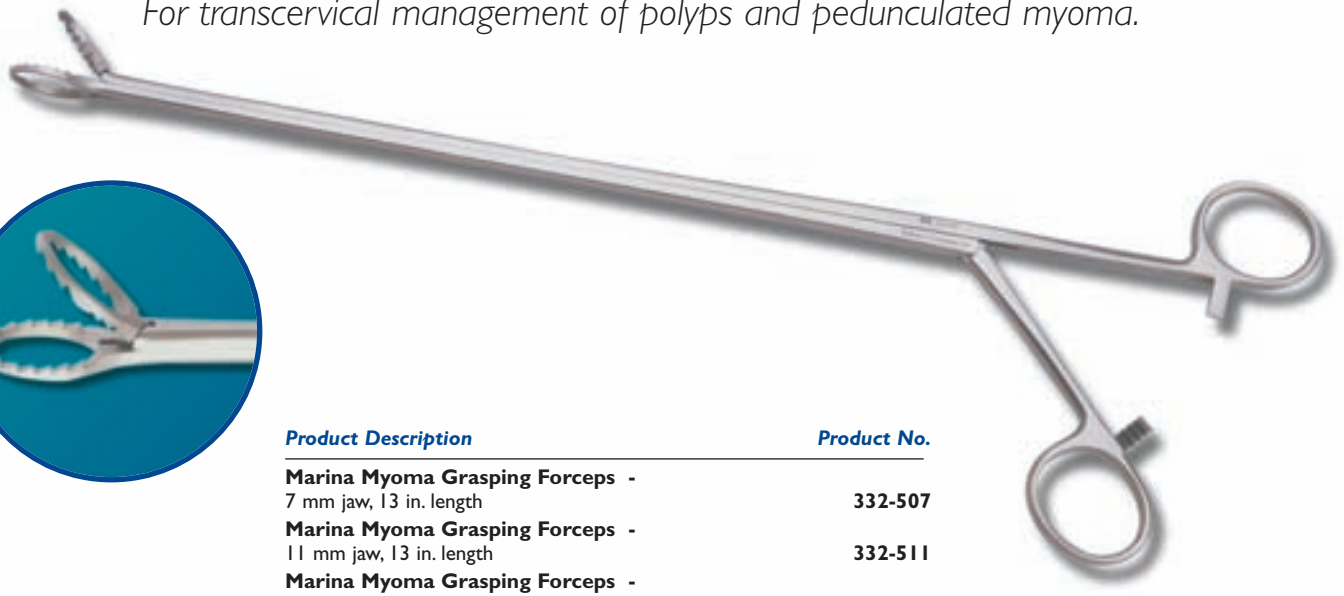

<i>Product Description</i>	<i>Product No.</i>
Marina Myoma Grasping Forceps - 7 mm jaw, 13 in. length	332-507
Marina Myoma Grasping Forceps - 11 mm jaw, 13 in. length	332-511
Marina Myoma Grasping Forceps - 17 mm jaw, 13 in. length	332-517

MARINA CERVICAL HOOKS

A wide variety of tip configurations including Emmet and Iris styles.

Emmet Hook

<i>Prod. Description</i>	<i>Product No.</i>
Full curve	295-201
Right angle	295-203
Double angle	295-205



Iris Hook

<i>Prod. Description</i>	<i>Product No.</i>
9.75 in. shaft	295-101

NEEDLE EXTENSIONS

- Convenient for cervical block. Use short needles only with small gauge to reduce bleeding
- Autoclavable, reusable

<i>Prod. Description</i>	<i>Product No.</i>
3 in.	337-003
4 in.	337-004
5 in.	337-005
6 in.	337-006





The Complete Source for Pelvic Reconstructive Surgical Instrumentation

MARINA MICROSURGERY INSTRUMENTS

Marina Medical offers a wide variety of fine German crafted microsurgery instruments.



Product Description

Product No.

Microsurgery Scissors, Round Handles

Straight, 6 in.	170-015
Straight, 7 in.	170-018
Curved, 6 in.	170-115
Curved, 7 in.	170-118

Microsurgery Forceps, Round Handles

Straight, Tying Platforms, 6 in.	171-015
Straight, Tying Platforms, 7 in.	171-018
Curved, Tying Platforms, 6 in.	171-115
Curved, Tying Platforms, 7 in.	171-118

Straight, 1 x 2 Teeth, 7 in.	171-416
Straight, 1 x 2 Teeth, 6 in.	171-418
Curved, 1 x 2 Teeth, 7 in.	171-516
Curved, 1 x 2 Teeth, 6 in.	171-518

Microsurgery Needleholders, Round Handles

Straight, No Catch, 6 in.	172-015
Curved, No Catch, 6 in.	172-115
Straight, with Catch, 5.5 in., (Flat Handle)	172-215
Curved, with Catch, 6 in.	172-218

Straight, No Catch, 7 in.	172-418
Curved, No Catch, 7 in.	172-518
Straight, with Catch, 7 in.	172-618
Curved, with Catch, 7 in.	172-718

Fallopian Tubal Forceps

10 mm jaws, 7 in. length	170-110
12 mm jaws, 7 in. length	170-112

MICRO DISSECTION NEEDLES

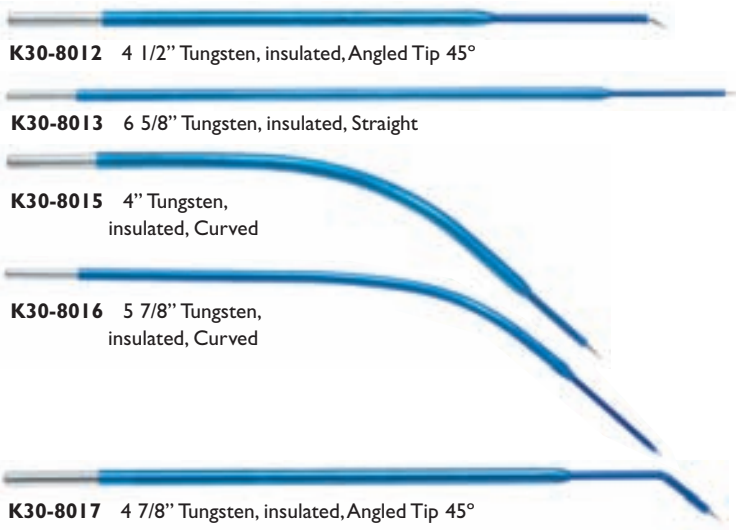

K30-8012 4 1/2" Tungsten, insulated, Angled Tip 45°

K30-8013 6 5/8" Tungsten, insulated, Straight

K30-8015 4" Tungsten, insulated, Curved

K30-8016 5 7/8" Tungsten, insulated, Curved

K30-8017 4 7/8" Tungsten, insulated, Angled Tip 45°

K30-8000 1 1/4" Tungsten, insulated, Straight

K30-8006 1 5/8" Tungsten, insulated, Straight

K30-8007 1 5/8" Tungsten, insulated, Angled Tip 45°

K30-8008 2" Tungsten, insulated, Straight

K30-8009 2" Tungsten, insulated, Angled Tip 45°



The New Wave in GYN

MARINA ENDOMETRIAL CURETTES



280-601 to 280-604
Novak Curette
1, 2, 3, and 4 mm

060-300
Singley
Cervical Forceps

280-601
280-602
280-603
280-604
Novak

Product Description	Length	Product No.
Singley Cervical Forceps	10 in.	060-300
Novak Curette, 1 mm	9.25 in.	280-601
Novak Curette, 2 mm	9.25 in.	280-602
Novak Curette, 3 mm	9.25 in.	280-603
Novak Curette, 4 mm	9.25 in.	280-604

MARINA UTERINE CURETTES AND DILATOR/SOUNDS

Sharp or Blunt Uterine Curettes with malleable stainless steel shafts. Uterine Sounds silver-plated or stainless steel graduated in centimeters.



280-200
Sims Curette

270-302
Sims Dilator Sound

SIMS CURETTES

Sharp, Malleable, 11 in.

Size	Product No.
#00, 5 mm	280-200
#0, 6 mm	280-210
#1, 7 mm	280-211
#2, 8 mm	280-212
#3, 9 mm	280-213
#4, 11 mm	280-214
#5, 12 mm	280-215
#6, 14 mm	280-216

THOMAS CURETTES

Blunt, Malleable, 11 in.

Size	Product No.
#1, 10 mm	280-311
#2, 11 mm	280-312
#3, 12 mm	280-313
#4, 13 mm	280-314
#5, 14 mm	280-315
#6, 15 mm	280-316

Sims Dilator/Sound, 12.5 in.

Product Description	Product No.
Malleable, Silver-Plated, in centimeters	270-302
Malleable, Stainless Steel, in centimeters	270-303



330-218
Schroeder



330-325
Braun

MARINA CERVICAL TENACULA & FORCEPS

Stainless steel, German made Schroeder or Braun Tenacula with custom or ultra-delicate tips.



330-325

070-600



160-330
Atraumatic Jaws

Product Description	Product No.
Schroeder Tenaculum, 10 in.	330-218
Braun Tenaculum, 10 in.	330-325
Atraumatic Tenaculum, 10 in.	160-330
Foerster Sponge Forceps, 10 in.	070-600



The Complete Source for Pelvic Reconstructive Surgical Instrumentation

MARINA IUD HOOKS & POLYP FORCEPS

Marina offers a selection of Specialty hooks and forceps designed for minimal patient trauma.



280-820
**Double IUD
Extractor**



280-801
**Simple
IUD Hook**



332-224

Flat Jaws



161-540

Flat Jaws



332-325

Cupped Jaws



332-224
**Javerts
Forceps**



161-540
**Randall
Cervical
Forceps**



332-325
**Desjardin
Forceps**

Product Description	Product No.
Simple IUD Hook, 10 in. length	280-801
Double IUD Extractor, 10.5 in.	280-820

Product Description	Product No.
Javerts Forceps, 9.5 in. length	332-224
Randall Cervical Forceps (flat jaws), 9 in. length	161-540
Desjardin Forceps (cupped jaws), 9.25 in. length	332-325



MARINA MEDICAL LLETZ PROGRAM

Marina Medical 300™ ESU Turnkey System • More Compact! More Powerful!

The Marina 300™ Electrosurgery Unit features five treatment modes:

- **Pure cut**
- **Blend**
- **Coagulation**
- **Fulguration**
- **Bipolar**

Powerful 120 watt Pure Cut and 80 watt Coagulation modes reduce electrode drag and assure quicker coagulation.

Five output modes. Digital diagnostic error codes. Optional Foot Control available.

Suitable for wall mount, roller cart or desk placement.



Complete Turnkey System includes:

Product Description	Product No.	Product Description	Product No.
Marina 300™ ESU* w/ Wall Mount Kit	300-300A	Electrode Sterilizing Case, 4 in. x 7.5 in. x 1.5 in.	300-200
Marina Smoke Evacuator w/ Foot Control includes ULPA Filter, Prefilter & Tubing	300-355	5 Disposable Loop Electrode, 15 mm x 8 mm	300-119
Reusable Hand Switching Pencil	300-510	5 Disposable Ball Electrode, 5 mm	300-159
Reusable Patient Return Cord	300-520	Graves Non-Conductive Speculum - Medium	310-102

* Marina 300™ ESU maximum power settings are 120w, Cut, 90w, Blend, 80w Coagulation, 40w Fulguration and 30w Bipolar.



The Complete Source for Pelvic Reconstructive Surgical Instrumentation

Non-Conductive Coating



MARINA NON-CONDUCTIVE INSTRUMENTS

- Marina instruments can be used with any LLETZ or LEEP system
- Highly reliable, autoclavable
- Built in smoke tubes on all "duckbill" specula
- Custom coated instruments on request

Clinton-Graves Speculum
310-602



SIDE WALL RETRACTORS

Product Description

Product No.

4-Sided Pederson Speculum, Medium	310-608
4-Sided Pederson Speculum, Large	310-609
Redundant Wall Retractor, 3.5 in. x .75 in. blades	310-610
Lateral Wall Retractor, Closed Shanks, 2.25 in. blades	310-611
Lateral Wall Retractor, Open Shanks, 2.5 in. blades	310-612

Marina Non-Conductive Instruments: SPECULA WITH SMOKE TUBES

Product Description

Product No.

Graves, Medium, 1.5 in. x 4 in. blades	310-102
Graves, Large, 1.5 in. x 4.75 in. blades	310-103
Pederson, Medium, 1 in. x 4 in. blades	310-202
Pederson, Large, 1 in. x 4.5 in. blades	310-203
Collin, Medium, 1.5 in. x 4 in. blades	310-302
Collin, Large, 1.75 in. x 4.25 in. blades	310-303
Weisman-Graves, Left, Medium	310-401
Weisman-Graves, Left, Large	310-402
Weisman-Graves, Right, Medium	310-451
Weisman-Graves, Right, Large	310-452
Weisman-Pederson, Right, Medium	310-460
VuMar, Medium	310-501
VuMar, Large	310-502
VuMar XL, Graves, Medium	310-503
VuMar XL, Graves, Large	310-504
VuMar XL, Pederson, Medium	310-515
VuMar XL, Pederson, Large	310-516
Clinton-Graves, Wide, 6 in. x 1.5 in.	310-602
Clinton-Pederson, Narrow, 6 in. x 1 in.	310-603

KOGAN ENDOCERVICAL SPECULA



Product Description

Product No.

Ratchet, Standard Tips, 11 in.	310-710
Ratchet, Narrow Tips, 11 in.	310-712
Set Screw, Standard Tips, 11 in.	310-714
Set Screw, Narrow Tips, 11 in.	310-716

SCHROEDER TENACULA



Product Description

Product No.

Schroeder Single-Tooth, Exposed Tips, 10 in.	310-830
Schroeder Single-Tooth, Coated Tips, 10 in.	310-832



Join the Marina Medical
PREFERRED CUSTOMER CLUB
And start earning valuable rewards.
Ask Your Rep Now



Non-Conductive Coating

MARINA NON-CONDUCTIVE INSTRUMENTS

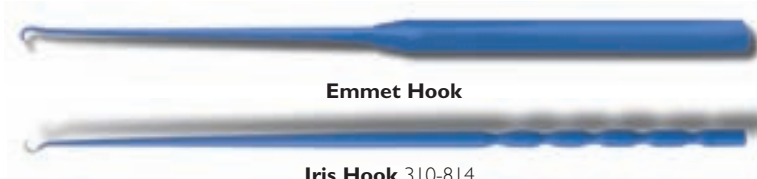

Emmet Hook

Iris Hook 310-814

Hooks

Product Description	Product No.
Emmet Hook, Fully Curved, 9 in.	310-811
Emmet Hook, Angled, 9 in.	310-812
Emmet Hook, Double-Angled, 9 in.	310-813
Iris Hook, 9 in.	310-814

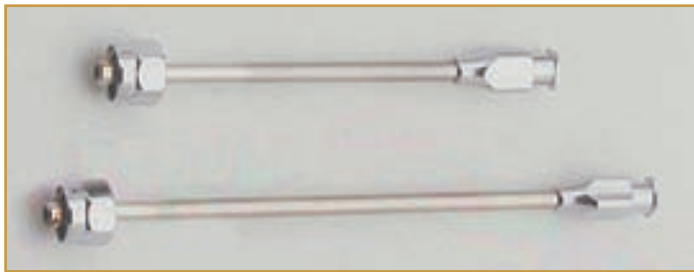

NEEDLE EXTENSIONS (STAINLESS STEEL)

Length	Product No.
3 in., 7.5 cm	337-003
4 in., 10 cm	337-004
5 in., 13 cm	337-005
6 in., 15 cm	337-006

FORCEPS W/O TEETH

Prod. Description	Product No.
Exposed Tips, 8 in.	310-834
Exposed Tips, 10 in.	310-850
Coated Tips, 10 in.	310-852

FORCEPS W/ TEETH

Prod. Description	Product No.
Exposed Tips, 6.75 in.	310-843
Coated Tips, 6.75 in.	310-844
Exposed Tips, 8 in.	310-840
Coated Tips, 8 in.	310-842
Exposed Tips, 10 in.	310-860
Coated Tips, 10 in.	310-862

MARINA ELECTRODE STERILIZATION TRAY

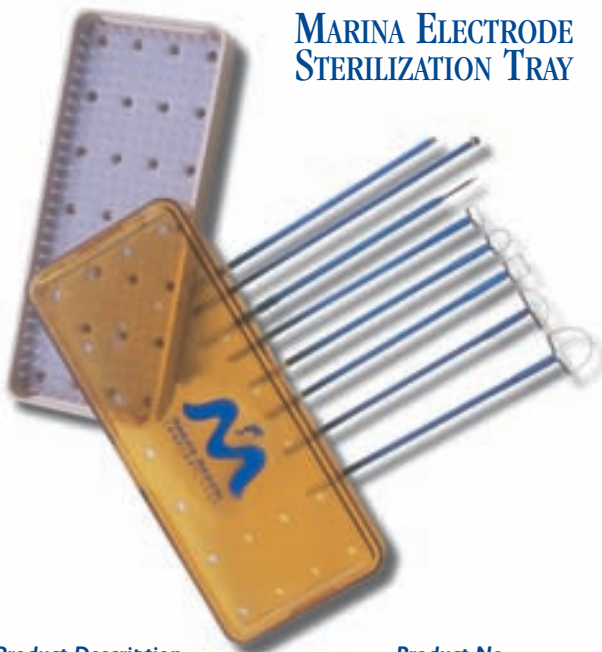

Product Description	Product No.
Autoclavable Electrode Sterilization Tray	300-200

MARINA MEDICAL LOOP, BALL & NEEDLE ELECTRODE



Lletz Electrodes
20 Different Sizes
 in compact boxes of 5



LLETZ ELECTRODE CHART

New
Electrode
Style



	ELECTRODE SIZE	DISPOSABLE PRODUCT NO.	REUSABLE PRODUCT NO.
	WIDTH/LENGTH 10 mm X 4 mm	300-112	300-012
	10 mm X 10 mm	300-118	N/A
	10 mm X 8 mm	N/A	300-016
	10 mm X 15 mm	300-124	300-024
	5 mm X 5 mm	300-113	300-013
	10 mm X 5 mm	300-115	300-015
	10 mm X 10 mm	300-117	300-017
	15 mm X 8 mm	300-119	300-019
	15 mm X 12 mm	300-120	300-020
	15 mm X 15 mm	300-121	300-021
	20 mm X 8 mm	300-123	300-023
	20 mm X 10 mm	300-125	300-025
	20 mm X 12 mm	300-126	300-026
	20 mm X 15 mm	300-127	300-027
	20 mm X 20 mm	300-128	300-028
	25 mm X 10 mm	300-129	300-029
	25 mm X 22 mm	300-132	N/A
	Fine Needle	300-169	300-069
	BALL SIZE 3 mm	300-149	300-049
	5 mm	300-159	300-059
	4 in. Extension	300-087	300-084

All electrodes are over-mold. Loop illustrations are shown for approximate size. All shaft lengths 5" (13 cm).



MARINA LLETZ ACCESSORIES

The Marina line of accessories provides you with one-stop-shopping...
Avoid the hassle of looking for the pieces... They are all here!



<i>Product Description</i>	<i>Product No.</i>	<i>For Use With</i>	<i>Use Instead of</i>
Adult Dispersive Electrode, Single-Use, 10 foot cable, for patients over 80 lbs., 25 per box	300-413	BEI Plus II Cooper Leep 1000 Utah Medical 400/401	BEI #395-302 Cooper #6050P



<i>Product Description</i>	<i>Product No.</i>	<i>For Use With</i>	<i>Use Instead of</i>
Adult Dispersive Electrode, Single-Use, no cable, 25 per box	300-415	Marina 300 Wallach Quantum 500	Wallach #909098



<i>Product Description</i>	<i>Product No.</i>	<i>For Use With</i>	<i>Use Instead of</i>
Adult Dispersive Electrode, Single-Use, no cable, 25 per box	300-425	Cabot/Circon ESU	3M #1149

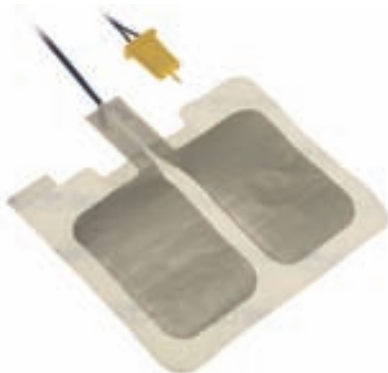

<i>Product Description</i>	<i>Product No.</i>	<i>For Use With</i>	<i>Use Instead of</i>
Dual Dispersive Electrode, Single-Use, 15 foot cable, 25 per box	300-435	ConMed Sabre 180 Wallach Quantum 2000	ConMed 60-7203-002 Wallach #909078



<i>Product Description</i>	<i>Product No.</i>	<i>For Use With</i>	<i>Use Instead of</i>
Dual Dispersive Electrode, Single-Use, no cable, 25 per box	300-455	Leisegang LM-90 Valley Labs Force I	Leisegang #72306 Valley Labs #E7509



Accessories

FOOT CONTROL & HAND CONTROL PENCILS



HAND CONTROL ELECTROPENCIL

Prod. Description	Product No.
Reusable, 3 Prong Fitting	300-516
Sterile, disposable, 3 prong fitting, Box of 20	300-515



FOOT CONTROL ELECTROPENCIL

Prod. Description	Product No.
Reusable, (includes Adapter Fitting #300-532)	300-504
Sterile, disposable, (use with Adapter #300-532), Box of 20	300-505



MARINA 300 ELECTROPENCIL

Prod. Description	Product No.
Specific to Marina 300 ESU for hand or foot control	300-510

ADAPTERS FOR ELECTROSURGERY UNITS



HANDPIECE ADAPTER

300-532

Specifically designed to connect single-use foot control electro pencil (#300-505) to most generators.



RETURN ELECTRODE PAD ADAPTER

300-535

Connects single-use pads (#300-413) to Cooper Leep 1000 generator.



SMOKE EVACUATION SYSTEMS

SURGIFRESH™ MINI TURBO

110V-120V/50 & 60HZ
Includes Footswitch

Product Description	Product No.
110V-120V	300-355
220V	300-351

WHEEL KIT ASSEMBLY

Product No. 300-352

PURE-VAC™ SYSTEM



"Cart mountable". Includes footswitch. Strong, quiet unit with "single use" filter. Excellent for use when cross contamination may be a problem.

Product No. 300-349



Accessories FOR SMOKE EVACUATION TUBING SETS



CORRUGATED TUBING ASSEMBLY

6 feet of corrugated tubing fixed to 2 feet of 1/2" tubing. Connects Mini-Vac Filter to Vaginal Speculum.

Prod. Description	Product No.
Single-use, Case of 3 2 foot PVC Tubing, 1/2 in. OD	305-843
Case of 5*	300-850

*Only for replacement of Distal end of corrugated set



STERILE 1/2" TUBING TO DSE

8 feet of 1/2" sterile tubing fitted to DSE Speculum tube, 9" length. Connects from Pre-Filter and Reducer to vaginal speculum slot.

Prod. Description	Product No.
Single-use, Sterile, Case of 10	300-842



Join the Marina Medical
PREFERRED CUSTOMER CLUB
And start earning valuable rewards
Ask Your Rep Now

DSE TUBING, 1/4" O.D., 9"



Used with #300-840/11 when purchased separately to fit the speculum slot instead of speculum smoke tube.

Prod. Description	Product No.
1/4 in. O.D., 9 in. length, Box of 50	305-845

PRE-FILTER FOR MINI-SMOKE EVACUATOR FILTER



Eliminates odors.
Sits on top of #300-833.

Prod. Description	Product No.
6 in. O.D., Case of 10	300-837



MINI-SMOKE EVACUATOR ULPA CHARCOAL FILTER

Used with Marina 2000
Smoke System.

Prod. Description	Product No.
12 in. long, 6 in. O.D.	300-833

MINI-VAC ULPA CHARCOAL FILTER



Use with Stackhouse Mini-Vac Evacuator.

Prod. Description	Product No.
7 1/2 in. long, 3 1/4 in. O.D.,	305-833

TUBING CONNECTORS (REDUCERS)



3/8" to 1 1/3"

Use to connect
Pre-Filter to 1/2"
tubing sets.



7/8" to 1 1/3"

Use to connect
Pre-Filter to
larger O.D.
tubing sets

Prod. Description	Product No.
Connects 3/8 in. to 1 1/3 in. tubing	300-838
Connects 7/8 in. to 1 1/3 in. tubing	300-839



MARINA MEDICAL PESSARY PRODUCTS

Marina Medical pessaries are 100% silicone pessaries that are used in the management of vaginal prolapse of the urogenital organs.

Marina Medical pessaries are soft and pliable, making them easy to insert and remove. Through the many sizes and shapes that are available, **Marina Medical** is able to offer many options for the wide range of needs of your patients.

THE RING PESSARY

SIZES AVAILABLE

Rings w/o Support

BR2.00	#1
BR2.25	#2
BR2.50	#3
BR2.75	#4
BR3.00	#5
BR3.25	#6
BR3.50	#7
BR3.75	#8
BR4.00	#9

Rings w/ Support

BR2.00S	#1
BR2.25S	#2
BR2.50S	#3
BR2.75S	#4
BR3.00S	#5
BR3.25S	#6
BR3.50S	#7
BR3.75S	#8
BR4.00S	#9

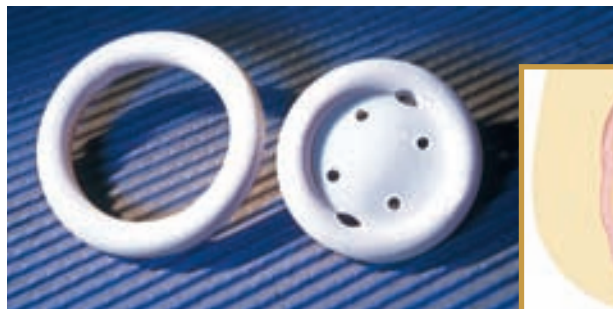

Available in nine sizes, both with and without support, this is a very common pessary for a first to second degree prolapse. The Ring with support can also be used on an accompanying cystocele. Insertion is eased with the folding action of the Ring.

THE OVAL PESSARY

SIZES AVAILABLE

Oval w/ Support

BOV2.00S	#1
BOV2.25S	#2
BOV2.50S	#3
BOV2.75S	#4
BOV3.00S	#5
BOV3.25S	#6
BOV3.50S	#7
BOV3.75S	#8
BOV4.00S	#9



Performs the same function as the Ring pessary but it is designed specifically to fit a narrow vaginal vault. It is available in nine sizes, all with support, and is used for a first to second degree prolapse as well as an accompanying cystocele.

SHAATZ

SIZES AVAILABLE

BSH1.50	#0
BSH1.75	#1
BSH2.00	#2
BSH2.25	#3
BSH2.50	#4
BSH2.75	#5
BSH3.00	#6
BSH3.25	#7
BSH3.50	#8



Available in nine sizes, is used for a first to second degree prolapse and an accompanying cystocele.



GELLHORN

SIZES AVAILABLE

BG1.50D	#0
BG1.75D	#1
BG2.00D	#2
BG2.25D	#3
BG2.50D	#4
BG2.75D	#5
BG3.00D	#6
BG3.25D	#7
BG3.50D	#8



Used for a second to third degree prolapse, or procidentia. It has drainage holes in its base and comes in nine sizes. The knob of the Gellhorn easily folds over for insertion, and once in place rests on the posterior vaginal wall.

DISH

SIZES AVAILABLE

Dish w/o Support

BDSH50	#0
BDSH55	#1
BDSH60	#2
BDSH65	#3
BDSH70	#4
BDSH75	#5
BDSH80	#6
BDSH85	#7

Dish w/ Support

BDSH50S	#0
BDSH55S	#1
BDSH60S	#2
BDSH65S	#3
BDSH70S	#4
BDSH75S	#5
BDSH80S	#6
BDSH85S	#7



THE INCONTINENCE DISH is used to relieve stress incontinence and minor degrees of prolapse. The Incontinence Dish comes with and without support. It is available in eight different sizes.

MAR-LAND

SIZES AVAILABLE

Mar-Land w/o Support

BM2.25	#2
BM2.50	#3
BM2.75	#4
BM3.00	#5
BM3.25	#6
BM3.50	#7
BM3.75	#8

Mar-Land w/ Support

BM2.25S	#2
BM2.50S	#3
BM2.75S	#4
BM3.00S	#5
BM3.25S	#6
BM3.50S	#7
BM3.75S	#8



Used for stress incontinence and minor prolapse. It is available both with and without support in seven different sizes.

HODGE

SIZES AVAILABLE

Hodge w/o Support

BHD65	#0
BHD70	#1
BHD75	#2
BHD80	#3
BHD85	#4
BHD90	#5
BHD95	#6
BHD100	#7
BHD105	#8
BHD110	#9

Hodge w/ Support

BHD65S	#0
BHD70S	#1
BHD75S	#2
BHD80S	#3
BHD85S	#4
BHD90S	#5
BHD95S	#6
BHD100S	#7
BHD105S	#8
BHD110S	#9



Has wires that allow it to be manually shaped for different anatomies. It can be used for a first to second degree prolapse, cystocele, stress incontinence and an incompetent cervix or uterine retroversion. It is available in ten sizes both with and without support. Because of the shapable wires, the Hodge pessary must be removed during x-rays, ultrasounds, and MRIs.



GEHRUNG

SIZES AVAILABLE

BGH50S	#0
BGH55S	#1
BGH60S	#2
BGH65S	#3
BGH70S	#4
BGH75S	#5
BGH80S	#6
BGH85S	#7
BGH90S	#8

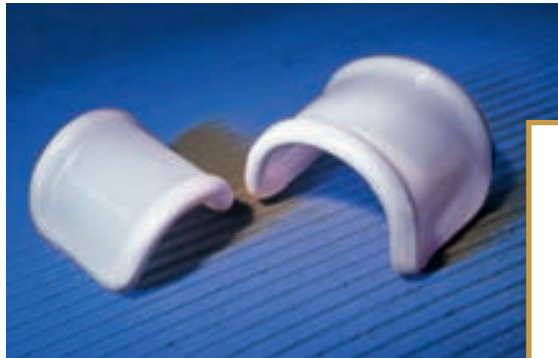

THE GEHRUNG pessary has wires that allow it to be manually shaped for different anatomies. It is used to support both cystoceles and rectoceles as well as second to third degree uterine prolapse. It is available in nine sizes. Because of the shapable wires, the Gehrung pessary must be removed during x-rays, ultrasounds, and MRIs.

DONUT

SIZES AVAILABLE

BD2.00	#0
BD2.25	#1
BD2.50	#2
BD2.75	#3
BD3.00	#4
BD3.25	#5
BD3.50	#6

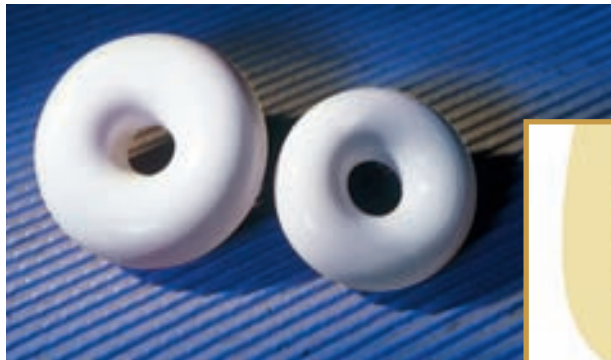

Designed for third degree prolapse as well as cystocele and rectocele. The soft donut can be compressed for insertion. It is available in seven sizes.

CUBE

SIZES AVAILABLE

Cube w/o Drain

BCU25	#0
BCU29	#1
BCU33	#2
BCU37	#3
BCU41	#4
BCU45	#5
BCU50	#6
BCU56	#7
BCU63	#8
BCU70	#9
BCU75	#10

Cube w/ Drain

BCU25D	#0
BCU29D	#1
BCU33D	#2
BCU37D	#3
BCU41D	#4
BCU45D	#5
BCU50D	#6
BCU56D	#7
BCU63D	#8
BCU70D	#9
BCU75D	#10



Designed for third degree prolapse, including procedentia, as well as a cystocele and rectocele. The Cube pessary is available both with and without drainage holes and has a silicone tie to aid in removal. The Cube is available in eleven sizes.



PESSARY GUIDELINES

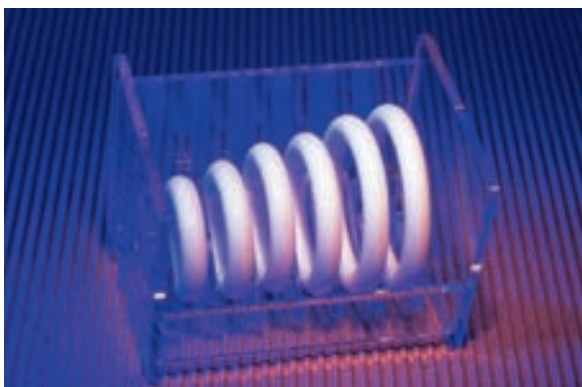

When fitting a pessary the clinician should perform a normal pelvic examination prior to the introduction and fitting of a pessary. The pelvic exam can help to determine the proper pessary size. The pessary fitting set can also be a useful tool in fitting most pessaries.

All of our pessaries fold or compress to ease insertion and removal. Fitting instructions for each style of pessary are included in the pessary package and should be followed. Patients should be instructed on pessary insertion and removal, as well as cleaning procedures as outlined in the package insert. Patients should be instructed to report any discomfort immediately and regular follow-up visits should be scheduled.

A properly fit pessary should be large enough to perform its designed function but not cause any undue pressure or discomfort. The clinician should be able to insert a finger between the outer rim of a properly fitted pessary and the vaginal wall.

All pessaries are contraindicated in patients who have acute genital tract infections, pelvic infections or are non-compliant.

FITTING SET

Set of six different sizes of ring pessaries that can be used to determine the proper size of pessary for each patient. Set comes with a cross reference chart that translates ring size into the correct size of other pessaries. **BFS1000**

PESSARY GUIDE

	PROLAPSE		CYSTOCELE	RECTOCELE	STRESS INCONTINENCE	RETRO <input type="checkbox"/> DISPLACEMENT	INCOMPETENT <input type="checkbox"/> CERVIX	COITUS WITH <input type="checkbox"/> PESSARY IN
	1ST - 2ND DEGREE	2ND - 3RD DEGREE						
RING	X		X					YES
OVAL	X		X					YES
SHAATZ		X	X					YES
DISH		X	X		X			YES
MAR-LAND		X	X		X			YES
GELLHORN		X	X	X				NO
DONUT		X	X	X				NO
CUBE		X	X	X				NO
GERHUNG		X	X	X				YES
HODGE	X		X		X	X	X	YES



OVERHEAD ZOOM COLPOSCOPE/VIDEO OVERHEAD ZOOM COLPOSCOPE

Product No.
MM-IOZM-310
MM-IVOZM-310 (with video, as shown)



- Superior zoom magnification
- Bright, clear, high resolution image
- Large field of view and excellent depth of field
- Convenient 45° incline eye tubes
- 310 mm working distance
- Pupillary distance adjustable from 54 mm to 75 mm
- Built-in Red-Free Green filter for better diagnosis
- Built-in C-Mount video camera adaptor on video version, video camera is not dedicated to the colposcope
- Lumax 5000 variable intensity 150 watt halogen fiber optic illumination
- Stainless steel instrument tray, easy to remove for sterilizing together with your instruments
- Colposcopy Instrument Set - highest quality German stainless - **available at special price when purchased with colposcope**
- Height range of objective from floor: 26" - 42 1/4"
- Maximum arm extension: 25"
- Counter-balanced articulating arm rotates 360° horizontally
- 5 year warranty of colposcope, 1 year warranty on cable and camera

OPTICAL DATA OF COLPOSCOPE
at 310 mm Working Distance

OCULAR	MAGNIFICATION	FIELD OF VIEW
5X	1.0X - 6.3X	201.0 mm - 30 mm
7.5X	1.5X - 9.5X	150.75 mm - 22.5 mm
10X	2.0X - 12.6X	100.5 mm - 15 mm
15X	3.0X - 19.0X	67.0 mm - 10.0 mm
20X	4.0X - 25.2X	50.25 mm - 7.5 mm

Specifications subject to change without notice.



Improve the Diagnosis of Your Patients...

ZOOM / VIDEO ZOOM COLPSCOPE

Superior Quality Japanese Optics
Continuous zoom

Light transfer housing with built-in
Red-Free Green filter

Heavy-duty fiber optic light cable

Interchangeable super wide field oculars.

Fine focus adjustment

Tilt adjustment

Height adjustment

Lumax 5000 variable
150 watt halogen
high intensity light source

Five leg heavy base with locking
wheels for extra stability

Product No.
MM-IZM-310
MM-IVZM-310 (with video, as shown)

- Superior zoom magnification
- Bright, clear, high resolution image
- Large field of view and excellent depth of field
- Convenient 45° incline eye tubes
- 310 mm working distance
- Pupillary distance adjustable from 54 mm to 75 mm
- Built-in Red-Free Green filter for better diagnosis
- Built-in C-Mount video camera adaptor on video version, adapts any standard 1/3" C-Mount video camera, video camera is not dedicated to the colposcope. Can be used with other systems
- Lumax 5000 variable intensity 150 watt halogen fiber optic illumination
- Stainless steel instrument tray, easy to remove for sterilizing together with your instruments
- Fine focus adjustment - 55 mm
- Height range of objective from floor: 37" - 48" (94 cm to 122 cm)
- 5 year warranty of colposcope, 1 year warranty on cable and camera

OPTICAL DATA OF COLPSCOPE at 310 mm Working Distance

OCULAR	MAGNIFICATION	FIELD OF VIEW
5X	1.0X - 6.3X	201.0 mm - 30 mm
7.5X	1.5X - 9.5X	150.75 mm - 22.5 mm
10X	2.0X - 12.6X	100.5 mm - 15 mm
15X	3.0X - 19.0X	67.0 mm - 10.0 mm
20X	4.0X - 25.2X	50.25 mm - 7.5 mm

Specifications subject to change without notice.



DIAGNOSTIC COLPSCOPE

The best and Most Economical Instrument for Simple, Accurate Assessment of the Cervix

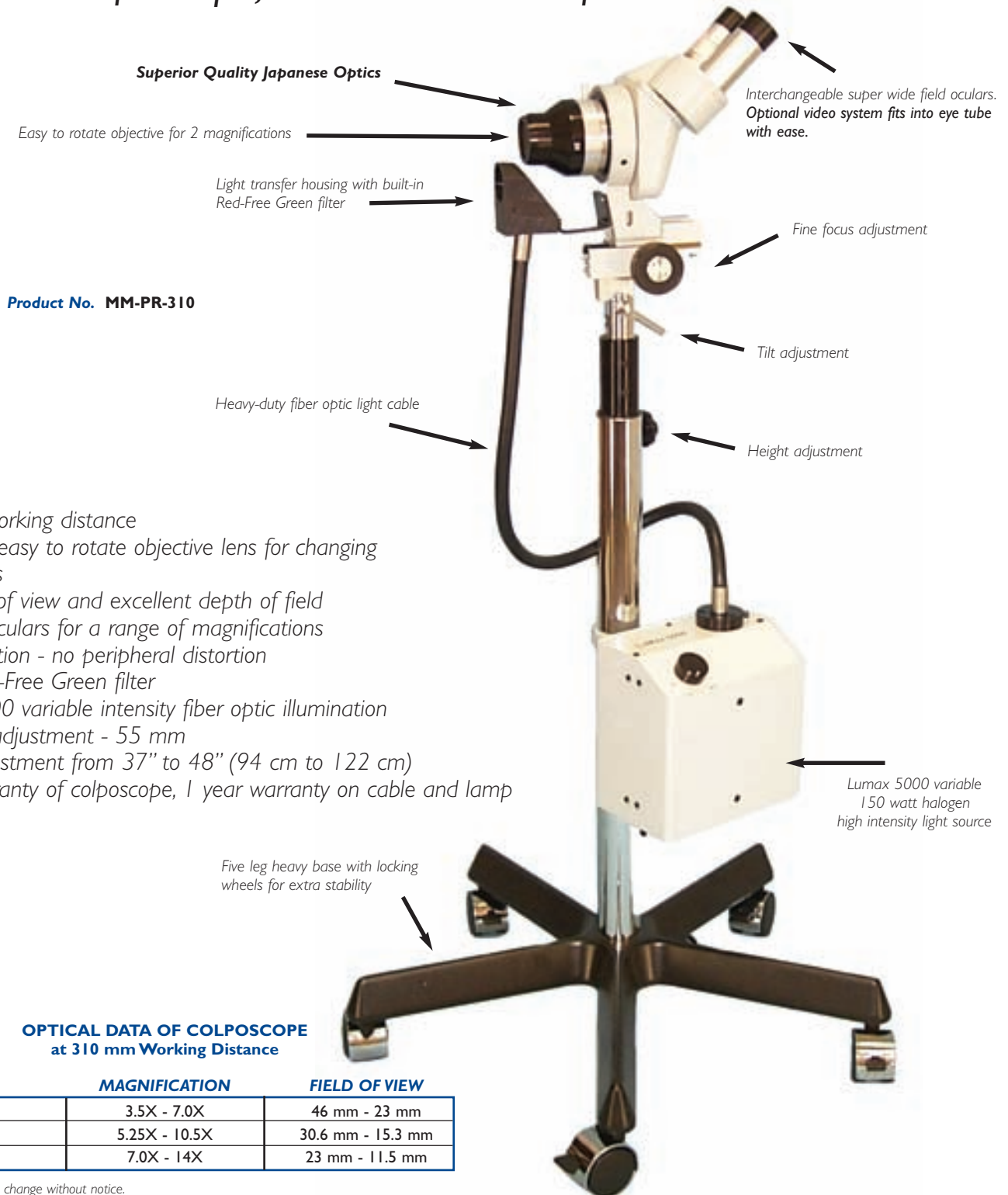

- 310 mm working distance
- Turret-type, easy to rotate objective lens for changing magnifications
- Large field of view and excellent depth of field
- Choice of oculars for a range of magnifications
- High resolution - no peripheral distortion
- Built-in Red-Free Green filter
- Lumax 5000 variable intensity fiber optic illumination
- Fine focus adjustment - 55 mm
- Height adjustment from 37" to 48" (94 cm to 122 cm)
- 5 year warranty of colposcope, 1 year warranty on cable and lamp

OPTICAL DATA OF COLPSCOPE
at 310 mm Working Distance

OCULAR	MAGNIFICATION	FIELD OF VIEW
10X	3.5X - 7.0X	46 mm - 23 mm
15X	5.25X - 10.5X	30.6 mm - 15.3 mm
20X	7.0X - 14X	23 mm - 11.5 mm

Specifications subject to change without notice.



HIGH RESOLUTION COLOR VIDEO CAMERA

Digital Signal Processing

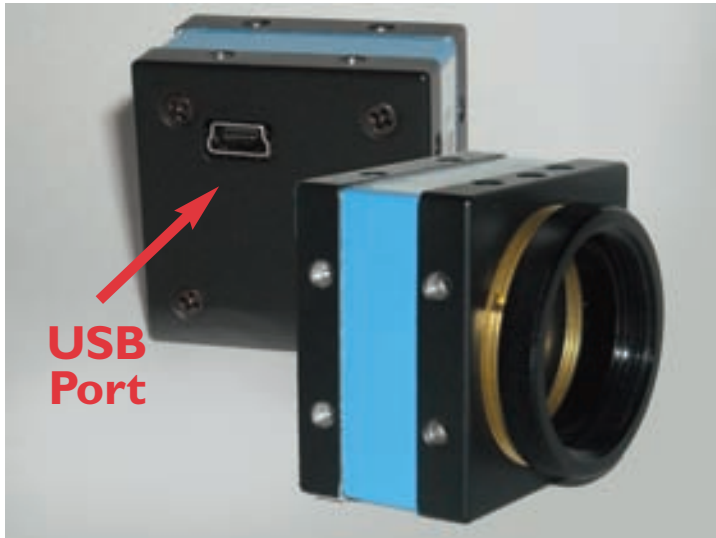

Technical Specifications for 45VS-00-USB

Lens Mount	C/CS Mount
Progressive Scan	1 / 2.5" Format CMOS
User Adjustable	From 1-5 Mega Pixels
IC Capture Software	WIN-XP, VISTA, 7 (Not Patient Mng. Software)
Dimensions	36 mm (w) x 36 mm (h) x 23 mm (d)
Weight	70 g

Technical Specifications for 45VS-00

Signal Format	NTSC / PAL
Image Sensor	1/3" Interline CCD (Sony)
Effective picture Element	768 (H) X 494 (V)
Scanning System	2:1 Interlace
Horizontal Frequency	15.734 Hz
Vertical Frequency	59.94 Hz
Sync System	Internal / External (HD /VD) Auto Changeover
Resolution	480 TV Lines
Minimum Illuminance	1 Lux at F 1.2
S/N Ratio	More than 48 dB (AGC + OFF)
g	0.45
White Balance	Full Auto / Manual Adjustment
Lens Mount	CS or C (with adaptor) Mount
AGC	ON / OFF Selectable
Electronic Shutter	Electronic Shutter: 1/60~1/10000 Fixed Shutter: Low Speed 2FDL~16FDL (8 step) High Speed shutter: 1/60~10000 (8 step) Flickerless Shutter
Video Out	VBS 1.0V p-p 75, Ohm, Y/C Out
Back Light	ON
Serial I/O	RS-232C
N/P Exchange	Selectable
Power Supply	DC10~12V
Power Consumption	180mA
Operating Temperature	-10°C~+40°C
Dimensions	51 mm (w) x 51 mm (h) x 55.5 mm (d)
Weight	190 g

Product Description

Product No.

High Resolution Color Video Camera (with USB port) **45VS-00-USB**
 High Resolution Color Video Camera (without USB port) **45VS-00**

Colposcope Accessories

Product Description

Product No.

Replacement Halogen bulb, 21V, 150W. **MMZM-150**
 Replacement Fuse, 110V or 220V (please specify) **MMZM-151**
 5X Oculars, (pair). **MMZMO-05**
 7.5X Oculars, (pair). **MMZMO-075**
 10X Oculars, (pair). **MMZMO-10**
 Rubber eye guards, (pair). **MMZM-EG**

Specifications subject to change without notice.



BIOMEDICAL IMAGE CAPTURING SOFTWARE

For Colposcopes and Hysteroscopes

Specialized software that captures, stores and transforms images from analogues to digital archives for integration into the Electronic Medical Report (EMR).

- Digitalize diagnostic images, integrating patient data and the electronic medical report
- Store images on CD, USB, external hard drive or hard drive for follow-up, comparisons and subsequent consultations
- Improve images using post-processing tools such as zoom, contrast, brightness, density, etc.
- Facilitate and expedite searches by patient name, ID and study date
- Generate periodic statistics by equipment, physician, date and procedure
- Customize electronic medical reports

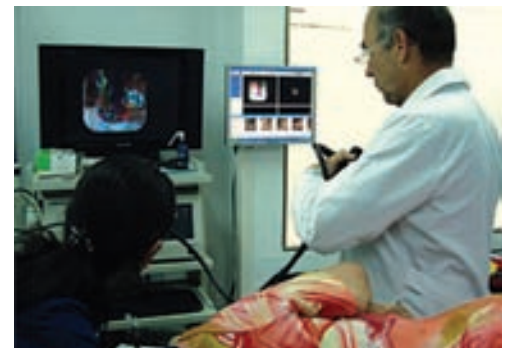

Product Description

Product No.

Biomedical Image Capturing Software

MM-BIOSOFT-1



PORTABLE HEADLIGHT SYSTEM



Product Description

Power Pack - LED Kit, Includes: Light, 2 rechargeable battery packs, adjustable beam, one wall charger and one padded carrying case

Headband Assembly with Light Clip (specify Rose or PP light)

Frame with Light Clip Assembly (specify frame style, color, size and light type)

Titanium frame with Light Clip Assembly (specify frame, color and light type)

Product No.

RM-PP

RM-HBL

RM-F/Lightclip

RM-TF/Lightclip

SURGICAL LOUPES



Product Description

Aluminum Frame (Purple)
Aluminum Frame (Silver)

Product No.

RM-AP
RM-AS

Product Description

Titanium Frame (Black)
Titanium Frame (Silver)

Product No.

RM-TB
RM-TS

Product Description

Loupe, 2.0 Soft Touch Safety (Long)
Loupe, 2.0 Soft Touch Safety (Short)
Loupe, 2.5 Soft Touch Safety (Long)

Product No.

RM 20L-ST
RM 20S-ST
RM 25L-ST



Product Description

Loupe, 2.0x Rose Safety-Red (Long)
Loupe, 2.0x Rose Safety-Black (Regular)
Loupe, 2.5 Rose Safety-Red (Long)
Loupe, 2.5 Rose Safety-Red (Regular)
Loupe, 2.5 Rose Safety-White (Regular)
Loupe, 3.5 Rose Safety-Red (Long)
Loupe, 3.5 Rose Safety-Red (Regular)
Loupe, 3.5 Rose Safety-White (Regular)
Loupe, 3.5 Rose Safety-Red (Short)

Product No.

RM 20L-RR
RM 20R-RB
RM 25L-RR
RM 25R-RR
RM 25R-RW
RM 35L-RR
RM 35R-RR
RM 35R-RW
RM 35S-RR

Accessories

Product Description

Cord Holder Soft Touch/Rose Frame
Cord Holder Titanium/Aluminum Frame
Cord Holder Velcro Strap-Any Frame

Product No.

RM-CHS
RM-CHT
RM-CHV

Head Band Assembly (Loupe Mount)
Head Strap (for Soft Touch Safety)
Head Strap (for Rose, Titanium, Aluminum & Steel)

RM-HB
RM-HS-Hard
RM-HS-Soft

Loupe Case Large-Soft Nylon (for framed loupes)

RM-LCL

Rose Light Case - Soft Nylon

RM-RLC

Steel Frame Side Shields (Set of 2)

RM-S-2

Titanium Frame Side Shields (Set of 2)

RM-T-2



The New Wave in GYN

TURNKEY OFFICE HYSTEROSCOPY SYSTEM

Marina Medical offers the highest quality, German-made optics and instruments for diagnostic and operative hysteroscopy. Our competitive pricing and large product range provides surgeons with the flexibility to compile a customized set of instruments while maximizing the return on their investment.



CAMERA & COUPLER

- 1 Chip CCD Camera, TV Resolution: 470 Lines, Sensitivity: 0.9 lux, C-Mount Camera head with cable (3m), S-VHS(YIC) and BNC
- Coupler 22 mm for Camera

Product Description	Product No.
Camera, 1 chip CCD	L201-2561-0
Coupler, 22 mm	L201-2561-9



LIGHT SOURCE

- Four Port turret Includes ACMI, Olympus, Storz & Wolf. Switch selectable between 115 and 230 volts

Product Description	Product No.
150 Watts Halogen	250-803SS
180 Watts Xenon	L200-8282-1
300 Watts Xenon	L200-8282-0
50 Watts LED	250-807



MONITORS

- Monitor for Endoscopic Equipment

Product Description	Product No.
21" Flat Screen	L200-5152-0
Medical Approved 19"	L200-5152-1

Specifications may change.



FIBEROPTIC CABLE

- Fiber optic Cable 3 meters (10 ft.) (ACMI Light Source/Storz Instrument)
- Autoclavable
- Any configuration available

Product Description	Product No.
Fiber Optic Cable, 5 mm bundle	350-372



SCOPES



HYSTEROSCOPE

Product Description	Product No.
2.7 mm Hysteroscope	700-063

- Hysteroscope, 30°, 2.7 mm OD, 30 cm length, Autoclavable (Same as 700-063)

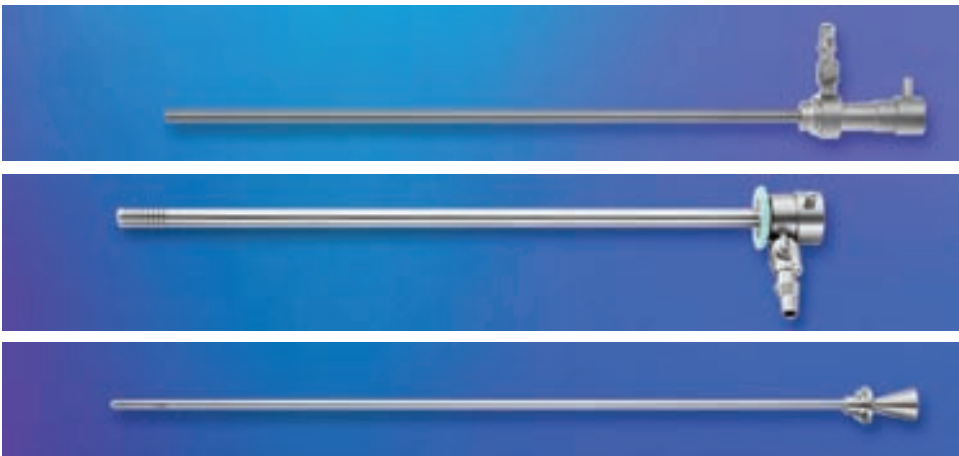

DIAGNOSTIC SHEATHS

- Hysteroscope Sheath for Diagnostic, 30° 3.7 mm OD, 277 mm L



Product Description	Product No.
Diagnostic Sheath	791-030
Outer Sheath	791-032
Obturator	791-033



THERAPEUTIC SHEATH

- Hysteroscope Sheath for Therapeutic, 1 Stopcock, 30° 5.3 mm OD, 19 cm L

Product Description	Product No.
Inner Sheath	791-034
Outer Sheath	791-040



SEMI-RIGID SCISSORS

Product Description	Product No.
Semi-Rigid Scissors, 5 fr	790-216



- Semi-Rigid Scissors, 5 Charr, Working Length 40 cm



SEMI-RIGID GRASPING FORCEPS

Product Description	Product No.
Semi-Rigid Grasping Forceps, 5 fr	790-219



- Semi-Rigid Grasping Forceps , alligator jaw 5 Charr, Working Length 40 cm



FLEXIBLE INSTRUMENTS

Recommended for the Turnkey Office Hysteroscopy System

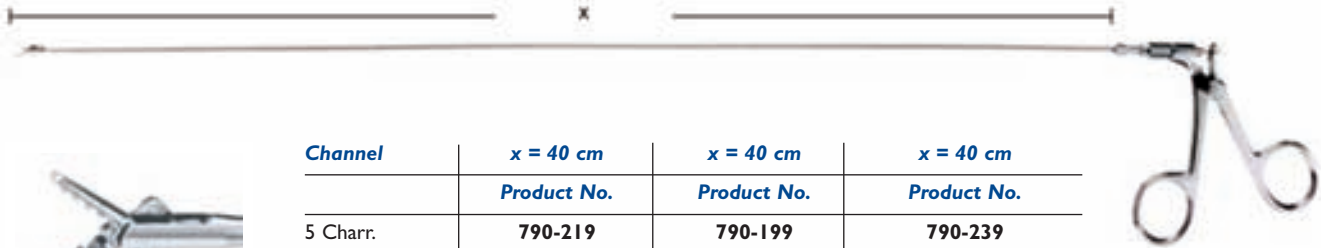

Channel	x = 40 cm	x = 40 cm	x = 40 cm
	Product No.	Product No.	Product No.
5 Charr.	790-219	790-199	790-239
7 Charr.	790-226	790-206	790-246
9 Charr.	790-227	790-207	790-247
	<i>Semi-Rigid</i>	<i>Flexible</i>	<i>Flexible & Insulated</i>



Channel	x = 40 cm	x = 40 cm	x = 40 cm
	Product No.	Product No.	Product No.
5 Charr.	790-217	790-197	790-237
7 Charr.	790-222	790-202	790-242
9 Charr.	790-223	790-203	790-243
	<i>Semi-Rigid</i>	<i>Flexible</i>	<i>Flexible & Insulated</i>



Channel	x = 40 cm	x = 40 cm	x = 40 cm
	Product No.	Product No.	Product No.
5 Charr.	790-218	790-198	790-238
7 Charr.	790-224	790-204	790-244
9 Charr.	790-225	790-205	790-245
	<i>Semi-Rigid</i>	<i>Flexible</i>	<i>Flexible & Insulated</i>



Channel	x = 40 cm	x = 40 cm	x = 40 cm
	Product No.	Product No.	Product No.
5 Charr.	790-216	790-196	790-236
7 Charr.	790-220	790-200	790-240
9 Charr.	790-221	790-201	790-241
	<i>Semi-Rigid</i>	<i>Flexible</i>	<i>Flexible & Insulated</i>



Channel	x = 40 cm	x = 40 cm	x = 40 cm
	Product No.	Product No.	Product No.
7 Charr.	790-263	790-262	790-264
	<i>Semi-Rigid</i>	<i>Flexible</i>	<i>Flexible & Insulated</i>



Channel	x = 40 cm	x = 40 cm	x = 40 cm
	Product No.	Product No.	Product No.
7 Charr.	790-255	790-250	790-258
9 Charr.	790-256	790-251	790-260
	<i>Semi-Rigid</i>	<i>Flexible</i>	<i>Flexible & Insulated</i>



SCOPES

All endoscopes are equipped with the fittings for all common light guides, (Storz, Olympus, Wolf, ACMI). All scopes correspond to DIN 58105, part 1 and 2 for rigid and flexible endoscopes. All eyepieces correspond to DIN 58105, part 2 and are therefore compatible to all common camera systems.

- The optical system is less sensitive to bending
- Higher flexibility compared to standard rigid endoscopes
- Higher robustness (70% of all repairing is due to broken rod-lenses caused by bent tubes)
- Scratch-proof sapphire glass on the distal end and ocular side
- High resolution and contrast reproduction
- 1 year warranty against broken rod-lenses

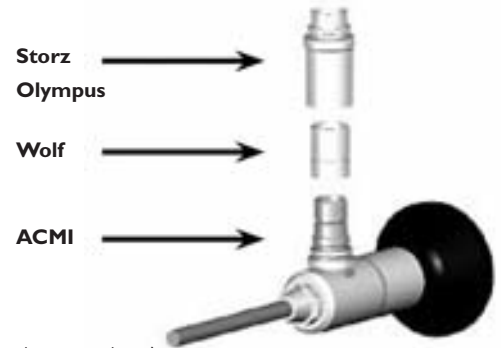

LAPAROSCOPES

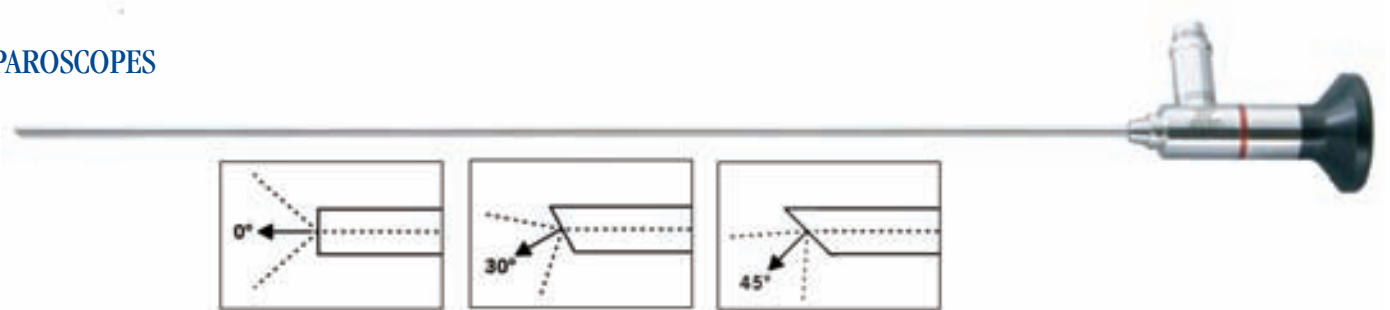

Working Length	Product No.	Product No.	Product No.
∅ 5.0 mm – 300 mm	700-000	700-003	700-004
∅ 6.5 mm – 300 mm	700-010	700-013	-
∅ 10.0 mm - 310 mm	700-020	700-023	700-024

HYSTEROSCOPES

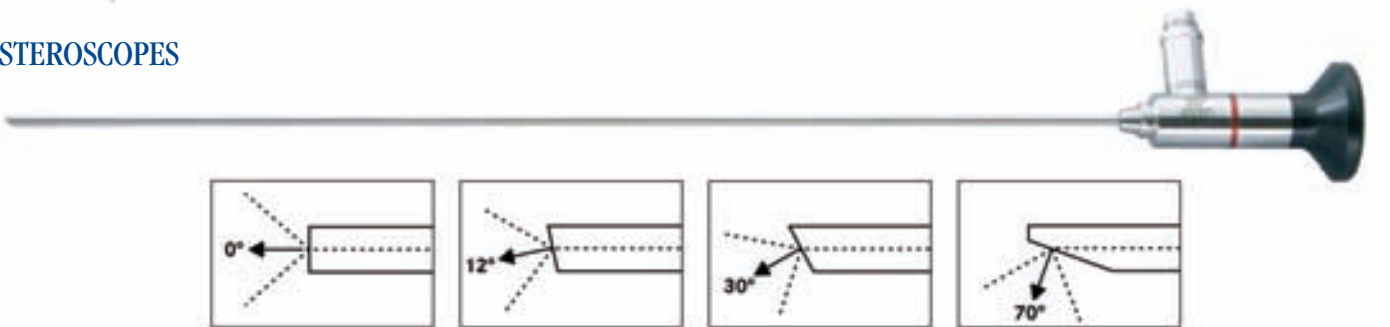

Working Length	Product No.	Product No.	Product No.	Product No.
∅ 2.7 mm – 302 mm	700-060	700-062	700-063	700-067
∅ 2.9 mm – 302 mm	700-081	700-082	700-085	-
∅ 4.0 mm - 302 mm	700-070	700-072	700-073	700-077

CYSTOSCOPES

∅ 2.7 mm – 302 mm	700-064	700-065	700-068	700-069
∅ 4.0 mm - 302 mm	700-074	700-075	700-078	700-079



The New Wave in GYN

DIAGNOSTIC SHEATHS

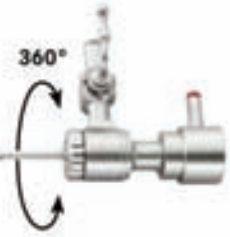

Product Description

Product No.

2.7 mm, For 0° Scope, Sheath - Ø 3.7 mm, Working Length - 277 mm	791-252
2.7 mm, For 30° Scope, Sheath - Ø 3.7 mm, Working Length - 277 mm	791-253
4.0 mm, For 0° Scope, Sheath - Ø 5.0 mm, Working Length - 277 mm	791-131
4.0 mm, For 30° Scope, Sheath - Ø 5.0 mm, Working Length - 277 mm	791-130

INNER SHEATHS



Product Description

Product No.

For 2.7 mm, 0° Scope, Sheath - Ø 3.7 mm, Working Length - 261 mm	791-031
For 2.7 mm, 30° Scope, Sheath - Ø 3.7 mm, Working Length - 261 mm	791-030
For 4.0 mm, 0° / 12° Scopes, Sheath - Ø 5.4 mm, Working Length - 260 mm	791-137
For 4.0 mm, 12° / 30° Scopes, Sheath - Ø 5.4 mm, Working Length - 260 mm	791-132

OUTER SHEATHS

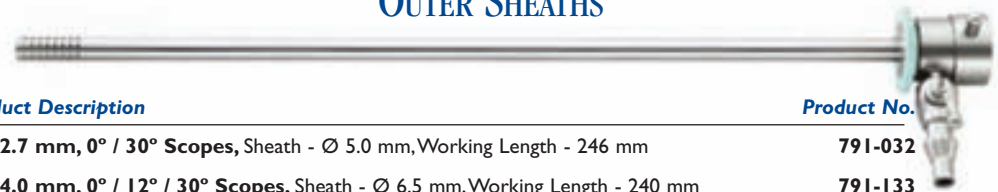

Product Description

Product No.

For 2.7 mm, 0° / 30° Scopes, Sheath - Ø 5.0 mm, Working Length - 246 mm	791-032
For 4.0 mm, 0° / 12° / 30° Scopes, Sheath - Ø 6.5 mm, Working Length - 240 mm	791-133

OBTURATORS



Product Description

Product No.

For 2.7 mm Scope	791-033
For 4.0 mm Scope	791-256

CONTINUOUS FLOW OPERATING SHEATHS

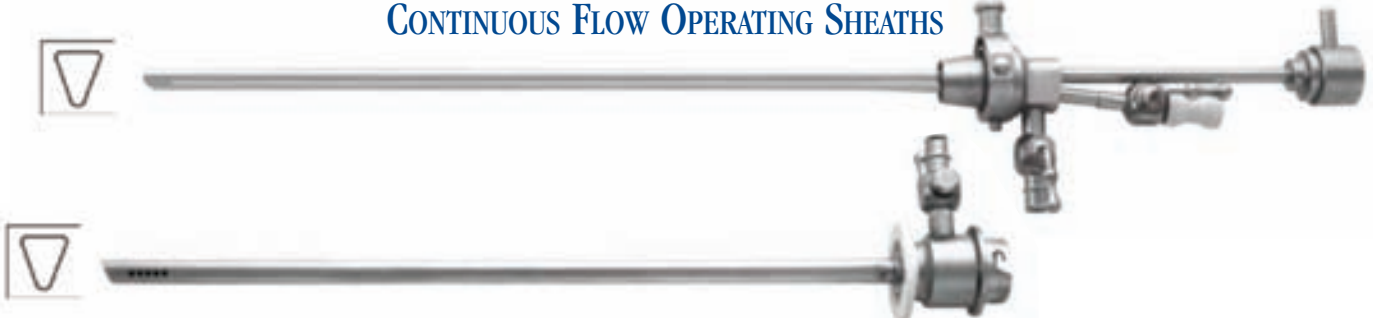

Product Description

Product No.

For 2.7 mm, 30° Scope, Inner Sheath - Ø 5.3 mm x 3.2 mm, Working Length - 187 mm	791-041
For 2.7 mm, 30° Scope, Outer Sheath - Ø 6.0 mm x 4.2 mm, Working Length - 190 mm	
For 4.0 mm, 30° Scope, Inner Sheath - Ø 7.1 mm x 4.4 mm, Working Length - 238 mm	791-043
For 4.0 mm, 30° Scope, Outer Sheath - Ø 7.8 mm x 5.3 mm, Working Length - 215 mm	



OPERATING SHEATHS

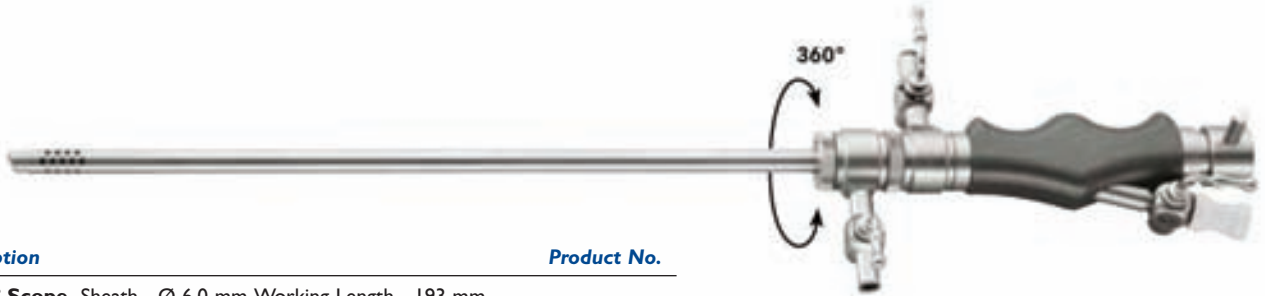

Product Description

Product No.

- 2.7 mm, For 0° Scope**, Sheath - Ø 6.0 mm, Working Length - 193 mm, 5 Charr. Instrument Channel **791-024**
- 2.7 mm, For 30° Scope**, Sheath - Ø 6.0 mm, Working Length - 193 mm, 5 Charr. Instrument Channel **791-026**
- 4.0 mm, For 0° Scope**, Sheath for continuous flow - Ø 8.0 mm, Working Length - 193 mm, 7 Charr. Instrument Channel **791-070**
- 4.0 mm, For 30° Scope**, Sheath for continuous flow - Ø 8.0 mm, Working Length - 193 mm, 7 Charr. Instrument Channel **791-072**

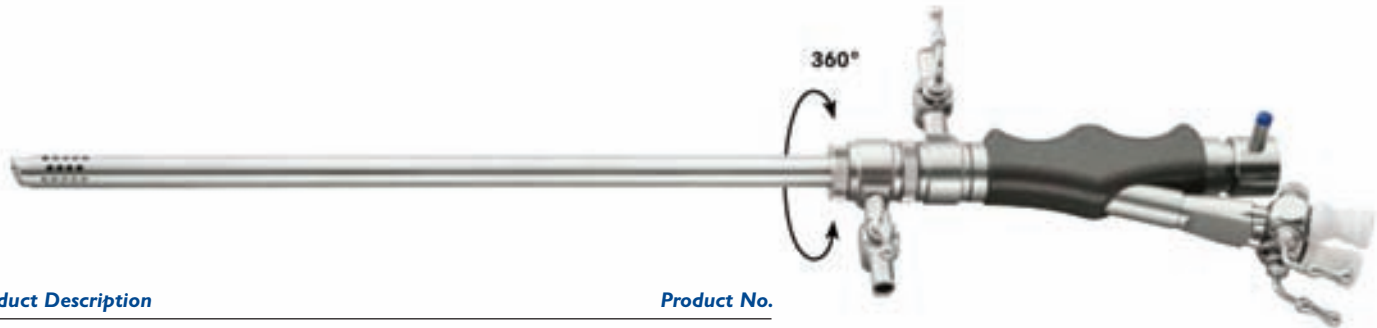

Product Description

Product No.

- 4.0 mm, For 0° Scope**, Sheath - Ø 8.0 mm, Working Length - 193 mm, 7 Charr. Two-Instrument Channels **791-074**
- 4.0 mm, For 30° Scope**, Sheath - Ø 8.0 mm, Working Length - 193 mm, 7 Charr. Two-Instrument Channels **791-076**



Product Description

Product No.

- 4.0 mm, For 0° Scope**, Sheath for continuous flow - Ø 8.0 mm, Working Length - 215 mm, 7 Charr. Two-Instrument Channels **791-125**
- 4.0 mm, For 30° Scope**, Sheath for continuous flow - Ø 8.0 mm, Working Length - 215 mm, 7 Charr. Two-Instrument Channels **791-127**



RESECTOSCOPY

Resectoscope sheath for continuous flow.

24 /26 Charr.



Rotates 360°

Product Description	Product No.
Outer Sheath	790-331
Inner Sheath	790-332
Obturator	790-323
Complete	790-330

Non-Rotatable

Product Description	Product No.
Outer Sheath	790-321
Inner Sheath	790-322
Obturator	790-323
Complete	790-320



Passive



Active







































Product Description	Product No.
Working Element, Passive Cutting	790-300
Working Element, Active Cutting	791-305



RESECTOSCOPY ELECTRODES

Monopolar, Single-Stem Electrodes



	Product Description	Product No.
	Knife Electrode, Angled 90°, 24 Charr. 	790-350
	Box of 6	791-350
	Knife Electrode, Angled 90°, 27 Charr. 	790-450
	Box of 6	791-450
	Loop Electrode, Straight, 24 Charr. 	790-351
	Box of 6	791-351
	Loop Electrode, Straight, 27 Charr. 	790-451
	Box of 6	791-451
	Loop Electrode, Angled 30°, 24 Charr. 	790-352
	Box of 6	791-352
	Loop Electrode, Angled 30°, 27 Charr. 	790-452
	Box of 6	791-452
	Loop Electrode, Angled 90°, 24 Charr. 	790-357
	Box of 6	791-357
	Loop Electrode, Angled 90°, 27 Charr. 	790-457
	Box of 6	791-457
	Vaporization Electrode, Serrated, Ø 3 mm 24 Charr. 	790-358
	Box of 6	791-358
	Vaporization Electrode, Serrated, Ø 3 mm, 27 Charr. 	790-458
	Box of 6	791-458
	Vaporization Electrode, Serrated, Ø 5 mm, 24 Charr. 	790-353
	Box of 6	791-353
	Vaporization Electrode, Serrated, Ø 5 mm, 27 Charr. 	790-453
	Box of 6	791-453
	Ball Electrode, Ø 3 mm, 24 Charr. 	790-354
	Box of 6	791-354
	Ball electrode, Ø 5 mm, 24 Charr. 	790-363
	Box of 6	791-363
	Ball electrode, Ø 5 mm, 27 Charr. 	790-463
	Box of 6	791-463
	Cone Electrode, 24 Charr. 	790-355
	Box of 6	791-355
	Vaporization Electrode 24 Charr. 	790-359
	Box of 6	791-359
	Roller Electrode, Smooth, Ø 3 mm, 24 Charr. 	790-367
	Box of 6	791-367
	Roller electrode, smooth, Ø 5 mm, 24 Charr. 	790-365
	Box of 6	791-365
	Protection Tube, (For sterilization of electrodes)	790-374



Accessories

CONTAINERS FOR ENDOSCOPY & MISCELLANEOUS ITEMS

STERILIZATION CONTAINER WITH INSERT

For resectoscopy set without instruments.



Product Description

Sterilization Container with Insert

Product No.

85109-01



Product Description

Adapter, (For Tenko, Storz, Olympus cold light cables)
Silicon Cap, (10 pieces)
End Screw for LL Rinsing Channels

Product No.

700-997
95010-00
95012-00

PROTECTION TUBE



Product Description

Autoclavable Protection Tube for Endoscopes

Product No.

700-999

PERFORATED CONTAINER FOR ENDOSCOPES

Includes bottom, lid and two silicon fittings.



Size	Color	Product No.
250 x 60 x 50 mm	Grey	87280-2F-SI
250 x 60 x 50 mm	Yellow	87280-2F-YE
250 x 60 x 50 mm	Green	87280-2F-GR
250 x 60 x 50 mm	Blue	87280-2F-BL
250 x 60 x 50 mm	Red	87280-2F-RE
250 x 60 x 50 mm	Black	87280-2F-BK
450 x 70 x 70 mm	Grey	87290-2F-SI
450 x 70 x 70 mm	Yellow	87290-2F-YE
450 x 70 x 70 mm	Green	87290-2F-GR
450 x 70 x 70 mm	Blue	87290-2F-BL
450 x 70 x 70 mm	Red	87290-2F-RE
450 x 70 x 70 mm	Black	87290-2F-BK

WIRE BASKET FOR ENDOSCOPES

Product Description

Wire Basket, (460 x 80 x 52 mm)
Wire Basket (290 x 80 x 52 mm)

Product No.

707-650
707-651





HASSON GRASPER

The Ultimate Instrument for Retraction of Myomas, Fibroids, Ovaries & Other Organs

Comes with finger slide handle. Three distinct styles available.



Product Description

Product No.

Hasson Grasper, Aggressive style, 3 prong
 Hasson Grasper, Aggressive style, 2 prong
 Hasson Grasper, 2 prong

NE27-0105
 NE27-0115
 NE27-0125

INSTRUMENTS FOR PUNCTURE



Product Description

Product No.

Myoma Drill, Working Length: Ø 5.0 mm, (X = 330 mm)
 Myoma Drill, Working Length: Ø 5.0 mm, (X = 420 mm)

332-519
 791-176



Product Description

Product No.

Myoma Drill, Working Length: Ø 10.0 mm, (X = 330 mm)
 Myoma Drill, Working Length: Ø 10.0 mm, (X = 420 mm)

791-174
 791-175

HASSON S-SHAPED RETRACTORS

S-Shaped Retractors facilitate the insertion of the Hasson Cannula by lateral or anterior posterior retraction of the entry site.

Prod. Description	Product No.
1/4 in.	08-0111
1/2 in.	08-0105
3/8 in.	08-0110



Custom widths available.

KROBACH TISSUE CLAMPS



Prod. Description

Product No.

7.0 mm Jaw: 25.5 cm / 10 in.
 10.0 mm Jaw: 25.5 cm / 10 in.

350-240
 350-242



Accessories

TROCARS



SizeApplication	Product No. Pyramidal	Product No. Conical Tip	Product No. Blunt	
Ø 3.5 mm		704-070	704-071	704-072
Ø 5.0 mm		704-005	704-021	704-030
Ø 5.5 mm		704-016	704-022	704-031
Ø 5.5 mm	Bariatric	704-016-15	704-022 -15	704-031-15
Ø 7.0 mm		704-014	704-018	—
Ø 8.0 mm		704-017	704-023	704-032
Ø 10.0 mm		704-013	704-024	704-033
Ø 10.5 mm		704-019	704-025	704-034
Ø 11.0 mm		704-006	704-026	704-035
Ø 11.0 mm	Bariatric	704-006-15	704-026-15	704-035-15
Ø 12.5 mm		704-012	704-027	704-036
Ø 12.5 mm	Bariatric	704-012-15	704-027-15	704-036-15
Ø 15.0 mm		704-015	04-028	704-037
Ø 20.0 mm		704-020	704-029	704-038

CAPS

10 pieces each



Trocar	Hole	Product No. Sealing Cap	Product No. Inner Sealing
Ø 5.0 mm	Ø 4.0 mm	704-0004 ●	704-0200 ●
Ø 5.5 mm	Ø 4.0 mm	704-0004 ●	704-0200 ●
Ø 6.5 mm	Ø 5.0 mm	704-0005 ●	704-0200 ●
Ø 7.0 mm	Ø 6.0 mm	704-0006 ●	704-0200 ●
Ø 8.0 mm	Ø 7.0 mm	704-0007 ●	704-0200 ●
Ø 10.0 mm	Ø 8.0 mm	704-0008 ●	704-0201 ●
Ø 11.0 mm	Ø 8.0 mm	704-0008 ●	704-0201 ●
Ø 12.5 mm	Ø 11.0 mm	704-0011 ●	704-0201 ●
Ø 15.0 mm	Ø 13.0 mm	704-0013 ●	704-0203 ●
Ø 20.0 mm	Ø 18.0 mm	704-0018 ●	704-0204 ●

10 pieces each



From — To	Hole	Product No.
Ø 5.5 mm - Ø 3.0 mm	Ø 2.0 mm	704-0002 ●
Ø 5.0 mm - Ø 4.0 mm	Ø 4.0 mm	704-0004 ●
Ø 10.0 mm - Ø 7.0 mm	Ø 6.0 mm	704-0006 ●
Ø 10.0 mm - Ø 5.5 mm	Ø 4.0 mm	704-0004 ●
Ø 11.0 mm - Ø 5.5 mm	Ø 4.0 mm	704-0004 ●
Ø 12.5 mm - Ø 5.5 mm	Ø 4.0 mm	704-0004 ●
Ø 15.0 mm - Ø 5.5 mm	Ø 4.0 mm	704-0004 ●
Ø 20.0 mm - Ø 5.5 mm	Ø 4.0 mm	704-0004 ●
Ø 12.5 mm Ø 10.0 mm	Ø 8.0 mm	704-0008 ●
Ø 15.0 mm Ø 10.0 mm	Ø 8.0 mm	704-0008 ●
Ø 20.0 mm Ø 10.0 mm	Ø 8.0 mm	704-0008 ●
Ø 20.0 mm Ø 15.0 mm	Ø 13.0 mm	704-0013 ●



Instruments for Laparoscopy

CANNULA SHEATHS & TROCARS

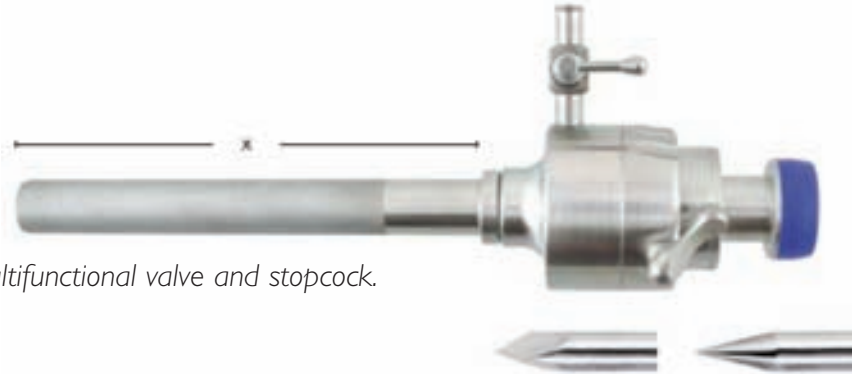

Trocar sheath with multifunctional valve and stopcock.

Sheath		With Multifunctional Valve (Sheath Only)	Sheath with Pyramidal Trocar	Sheath with Conical Trocar
Size	Length	Product No.	Product No.	Product No.
Ø 3.5 mm	X = 92 mm	704-359	704-369	704-379
Ø 5.5 mm	X = 95 mm	704-360	704-370	704-380
Ø 7.0 mm	X = 95 mm	704-362	704-372	704-382
Ø 10.0 mm	X = 97 mm	704-364	704-374	704-384
Ø 11.0 mm	X = 101 mm	704-365	704-375	704-385
Ø 12.5 mm	X = 98 mm	704-366	704-376	704-386
Ø 15.0 mm	X = 95 mm	704-367	704-377	704-328
Ø 20.0 mm	X = 95 mm	704-368	704-378	704-325

Bariatric Trocar sheath with multifunctional valve and stopcock.



Sheath		With Multifunctional Valve (Sheath Only)	Sheath with Pyramidal Trocar	Sheath with Conical Trocar
Size	Length	Product No.	Product No.	Product No.
Ø 5.5 mm	x = 150 mm	704-4002-15	704-4032 -15	704-4052-15
Ø 11.0 mm	x = 150 mm	704-4010-15	704-4040-15	704-4060-15
Ø 12.5 mm	x = 150 mm	704-4012-15	704-4042 -15	704-4062-15



SAFETY TROCARS

OBLIQUE, DETACHED



Product Description

Product No.

Safety Trocar, Oblique, Detachable, Working Length: Ø 5.0 mm (x = 157 mm)	704-059
Safety Trocar, Oblique, Detachable, Working Length: Ø 5.5 mm (x = 160 mm)	704-060
Safety Trocar, Oblique, Detachable, Working Length: Ø 8.0 mm (x = 171 mm)	704-039
Safety Trocar, Oblique, Detachable, Working Length: Ø 10.0 mm (x = 167 mm)	704-063
Safety Trocar, Oblique, Detachable, Working Length: Ø 11 mm (x = 171 mm)	704-061
Safety Trocar, Oblique, Detachable, Working Length: Ø 12.5 mm (x = 171 mm)	704-061

PYRAMIDAL, DETACHED



Product Description

Product No.

Safety Trocar, Pyramidal, Detachable, Working Length: Ø 5.0 mm (x = 157 mm)	704-064
Safety Trocar, Pyramidal, Detachable, Working Length: Ø 5.5 mm (x = 160 mm)	704-065
Safety Trocar, Pyramidal, Detachable, Working Length: Ø 8.0 mm (x = 171 mm)	704-079
Safety Trocar, Pyramidal, Detachable, Working Length: Ø 10.0 mm (x = 167 mm)	704-066
Safety Trocar, Pyramidal, Detachable, Working Length: Ø 11 mm (x = 171 mm)	704-067
Safety Trocar, Pyramidal, Detachable, Working Length: Ø 12.5 mm (x = 171 mm)	704-068

BARIATRIC SAFETY TROCAR, PYRAMIDAL, DETACHED



Product Description

Product No.

Bariatric Safety Trocar, Pyramidal, Detachable, Working Length: Ø 5.0 mm (x = 215 mm)	704-076
Bariatric Safety Trocar, Pyramidal, Detachable, Working Length: Ø 11.0 mm (x = 220 mm)	704-077
Bariatric Safety Trocar, Pyramidal, Detachable, Working Length: Ø 12.5 mm (x = 223 mm)	704-078

Accessories

REDUCTION SLEEVES



Size	Size	Product No.
Ø 5.0 mm	Ø 3.0 mm	704-232
Ø 5.0 mm	Ø 4.0 mm	704-200
Ø 10.0 mm	Ø 5.5 mm	704-010
Ø 10.0 mm	Ø 7.0 mm	704-234
Ø 11.0 mm	Ø 5.5 mm	704-000
Ø 12.5 mm	Ø 5.5 mm	704-216
Ø 15.0 mm	Ø 5.5 mm	704-203
Ø 20.0 mm	Ø 5.5 mm	704-206
Ø 12.5 mm	Ø 10.0 mm	704-217
Ø 15.0 mm	Ø 10.0 mm	704-204
Ø 20.0 mm	Ø 10.0 mm	704-207
Ø 20.0 mm	Ø 15.0 mm	704-218

DISTANCE HOLDER WITH FIXATION THREAD



Size	Product No.
35.0 mm	
Ø 5.0 mm	704-435
Ø 5.0 mm	704-436
Ø 10.0 mm	704-437
Ø 11.0 mm	704-438
Ø 12.5 mm	704-439

REDUCTION ADAPTORS WITH SILICON HOLDERS



Size	Size	Product No.
Ø 10.0 mm	Ø 5.5 mm	704-235
Ø 11.0 mm	Ø 5.5 mm	704-236
Ø 12.5 mm	Ø 5.5 mm	704-237
Ø 12.5 mm	Ø 10.0 mm	704-238

REDUCTORS



Size	Size	Product No.
Ø 10.0 mm	Ø 5.5 mm	704-240
Ø 11.0 mm	Ø 5.5 mm	704-241
Ø 12.5 mm	Ø 5.5 mm	704-242



3-BLADE RETRACTOR

Suitable for
10 mm
Instruments



Product Description

3-Blade Retractor, 90° Angled,
Length of blade: 70 mm

Product No.

704-860

DILATORS



Product Description

Dilation — Set from Ø 5.0 mm - Ø 10.0 mm
Dilation — Set from Ø 5.0 mm - Ø 11.0 mm
Dilation — Set from Ø 5.0 mm - Ø 15.0 mm
Dilation — Set from Ø 5.0 mm - Ø 20.0 mm
Dilation — Set from Ø 10.0 mm - Ø 15.0 mm
Dilation — Set from Ø 10.0 mm - Ø 20.0 mm

Product No.

704-220
704-225
704-221
704-222
704-223
704-224

INSUFFLATION NEEDLE



Product Description

Ø 2.0 mm, Length: 55 mm
Ø 2.0 mm, Length: 100 mm
Ø 2.0 mm, Length: 120 mm
Ø 2.0 mm, Length: 140 mm
Ø 2.0 mm, Length: 150 mm
Ø 2.0 mm, Length: 180 mm
Ø 2.0 mm, Length: 200 mm

Product No.

704-095
704-098
704-100
704-099
704-101
704-102
704-103

SUCTION & IRRIGATION CANNULAS

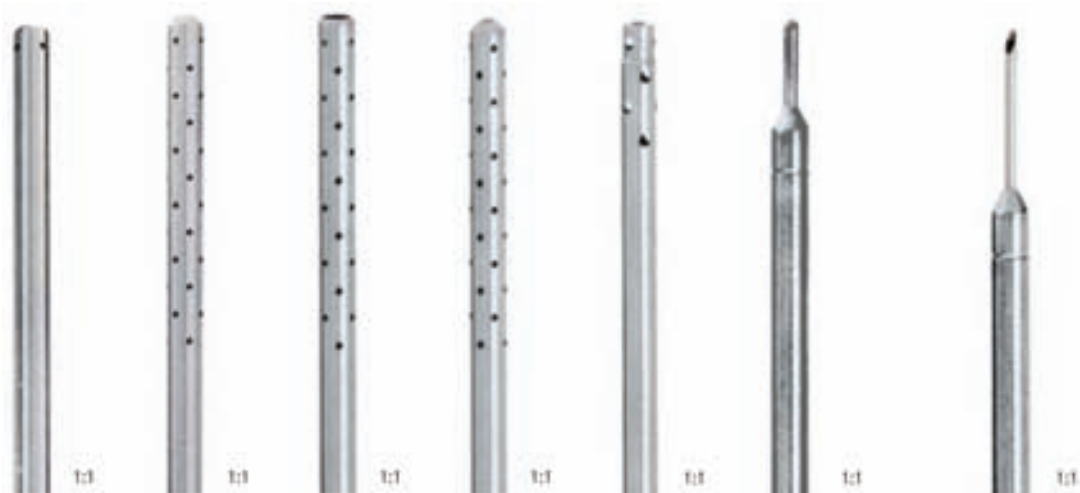

	Product No.	Product No.	Product No.	Product No.	Product No.	Product No.	Product No.
Size	330 mm	330 mm	330 mm	500 mm	330 mm	330 mm	330 mm
Ø 5.0 mm	704-660	704-656	704-650	704-654	704-652	704-658	704-662
	Standard	Blunt		Blunt	Blunt	Dissection Cannula	Punction Cannula



SUCTION & IRRIGATION CANNULAS

HANDLE WITH TRUMPET VALES AND LARGE TUBE CONNECTOR



Product Description	Product No.
Ø 5.0 mm, Length: 330 mm	704-608
Ø 10.0 mm, Length: 330 mm	704-607
Trumpet Valve	704-605
Complete Set	704-610



704-605



704-608



704-607

PUNCTION AND INJECTION CANNULAS



Product Description	Product No.
Cannula with Trumpet Valves, with Laser Tube, Ø 5.0 mm, Length: 340 mm	704-580
Cannula with Trumpet Valves, without Laser Tube, Ø 5.0 mm, Length: 340 mm	704-582

TWO-WAY STOPCOCK

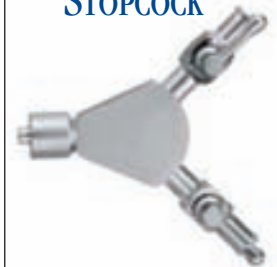

Two-Way Stopcock with LL
704-121



Product Description	Product No.
Ø 5.0 mm, Punction and Injection Cannula, LL-Connection, Needle, Ø 1.4 mm, Length: 330 mm	704-120
Ø 5.0 mm, Punction and Injection Cannula, LL-Connection, Needle, Ø 1.4 mm, Length: 340 mm	704-582

MODULAR SUCTION / IRRIGATION SYSTEMS

HANDLE WITH TRUMPET VALES



Product Description	Product No.
Suction / Irrigation Handle with 2 Trumpet Valves, Tube Connector (M8x1 mm) and Lateral LL-Connector	704-710

PISTOL HANDLE WITH TRUMPET VALES



Product Description	Product No.
Suction / Irrigation Pistol Handle with 2-Way Valve and Two Tube Connectors, for adaptable tubes (M8x1 mm)	704-715



Product Description	Product No.	Product Description	Product No.
Ø 3.0 mm, with 4 holes	704-720	Ø 3.0 mm, with 4 x 4 holes	704-730
Ø 5.0 mm, with 4 holes	704-721	Ø 5.0 mm, with 4 x 4 holes	704-731
Ø 10.0 mm, with 4 holes	704-722	Ø 10.0 mm, with 4 x 4 holes	704-732



Product Description	Product No.
Ø 3.0 mm, Optic Flushing Tube with Angled Flush Opening, Connection (M8x1 mm)	704-740



Product Description	Product No.
Ø 5.0 mm, Punction / Injection Needle, Ø 1.0 mm, Connection (M8x1 mm)	704-745



MODULAR SUCTION / IRRIGATION SYSTEMS

<i>Product Description</i>	<i>Product No.</i>
 Wire Hook , Ø 5.0 mm, 340 mm	795-4911
 Hook , Ø 5.0 mm, 340 mm	795-4912
 90° Hook , Ø 5.0 mm, 340 mm	795-4913
 Spatula , Ø 5.0 mm, 340 mm	795-4914
 Ball Point , Ø 5.0 mm, 340 mm	795-4915
 Knife , Ø 5.0 mm, 340 mm	795-4916
 45° Electrode , Ø 5.0 mm, 340 mm	795-4917
 Needle , Ø 5.0 mm, 340 mm	795-4918
 Cone , Ø 5.0 mm, 340 mm	795-4919

HANDLE WITH 2-WAY VALVE

For adaptable HF-electrodes with suction/irrigation channel. With rotating adaptor and lateral HF-connector. Two universal hose connectors.



<i>Product Description</i>	<i>Product No.</i>
Handle with 2-Way Valve	795-4910

HANDLE WITH 2 TRUMPET VALVES

Detachable ergonomic handle plate; for adaptable HF-electrodes with suction / irrigation channel.



<i>Product Description</i>	<i>Product No.</i>
Suction / Irrigation Handle with 2 Trumpet Valves	795-4900

HANDLE STYLES FOR ENDOSCOPIC INSTRUMENTS

Can Be Dismounted Into 3 Parts • All Instruments are Exchangeable

- Spare Parts or Repair Costs Lower for Dismountable Forceps
- Dismountability Allows for Best Possible Cleaning & Sterilization
 - All Parts are Connected with a Screw Thread
- CF Handle is Lighter and Available on 5 mm Instruments



CARBON FIBER w/ HF POST

- 360° rotatable, detachable

Product No.
775-4003SC

CARBON FIBER RATCHET w/ HF POST

- 360° rotatable, detachable

Product No.
775-4004SC





ROTABLE AND DETACHABLE SCISSORS



Insulated, without ratchet.

	Product Description	Product No.
	Hook Scissors , Ø 5.0 mm, 250 mm	775-4020-25 C
	Hook Scissors , Ø 5.0 mm, 330 mm	775-4020 C
	Hook Scissors , Ø 5.0 mm, 450 mm	775-4020-45 C
	Metzenbaum Scissors , Ø 5.0 mm, 250 mm	775-4022-25-C
	Metzenbaum Scissors , Ø 5.0 mm, 330 mm	775-4022 C
	Metzenbaum Scissors , Ø 5.0 mm, 450 mm	775-4022-45 C
	Metzenbaum Scissors, Curved , Ø 5.0 mm, 250 mm	775-4023-25-C
	Metzenbaum Scissors, Curved , Ø 5.0 mm, 330 mm	775-4023 C
	Metzenbaum Scissors, Curved , Ø 5.0 mm, 450 mm	775-4023-45 C
	Micro Scissors , Ø 5.0 mm, 250 mm	775-4024-25 C
	Micro Scissors , Ø 5.0 mm, 330 mm	775-4024 C
	Micro Scissors , Ø 5.0 mm, 450 mm	775-4020-45 C
	Micro Scissors Curved , Ø 5.0 mm, 340 mm	775-4025-25 C
	Micro Scissors Curved , Ø 5.0 mm, 330 mm	775-4025 C
	Micro Scissors Curved , Ø 5.0 mm, 450 mm	775-4025-45 C
	Peritoneal Scissors , One Serrated Blade, Ø 5.0 mm, 250 mm	775-4026-25 C
	Peritoneal Scissors , One Serrated Blade, Ø 5.0 mm, 330 mm	775-4026 C
	Hook Scissors , One Serrated Blade, Ø 5.0 mm, 450 mm	775-4026-45 C
	Metzenbaum Scissors, Curved, Long , Ø 5.0 mm, 250 mm	775-4027-25-C
	Metzenbaum Scissors, Curved, Long , Ø 5.0 mm, 330 mm	775-4027 C
	Metzenbaum Scissors, Curved, Long , Ø 5.0 mm, 450 mm	775-4027-45 C
	OP Scissors , Ø 5.0 mm, 250 mm	775-4028-25-C
	OP Scissors , Ø 5.0 mm, 330 mm	775-4028 C
	OP Scissors , Ø 5.0 mm, 450 mm	775-4028-45 C
	OP Scissors, Curved , Ø 5.0 mm, 250 mm	775-4029-25-C
	OP Scissors, Curved , Ø 5.0 mm, 330 mm	775-4029 C
	OP Scissors, Curved , Ø 5.0 mm, 450 mm	775-4029-45 C



ROTABLE AND DETACHABLE BIOPSY FORCEPS



Insulated,
without ratchet.



Insulated,
with ratchet.

	Product Description	Product No.	Product No.
	Biopsy Forceps, Ø 5.0 mm, 250 mm Biopsy Forceps, Ø 5.0 mm, 330 mm Biopsy Forceps, Ø 5.0 mm, 450 mm	775-4030-25 C 775-4030 C 775-4030-45 C	775-4030-25 CS 775-4030 CS 775-4030-45 CS
	Biopsy Forceps, Serrated with Tooth, Ø 5.0 mm, 250 mm Biopsy Forceps, Serrated with Tooth, Ø 5.0 mm, 330 mm Biopsy Forceps, Serrated with Tooth, Ø 5.0 mm, 450 mm	775-4031-25 C 775-4031 C 775-4031-45 C	775-4031-25 CS 775-4031 CS 775-4031-45 CS
	Biopsy Forceps, Through Cutting, Ø 5.0 mm, 250 mm Biopsy Forceps, Through Cutting, Ø 5.0 mm, 330 mm Biopsy Forceps, Through Cutting, Ø 5.0 mm, 450 mm	775-4034-25 C 775-4034 C 775-4034-45 C	775-4034-25 CS 775-4034 CS 775-4034-45 CS
	Biopsy Forceps, Ø 5.0 mm, 250 mm Biopsy Forceps, Ø 5.0 mm, 330 mm Biopsy Forceps, Ø 5.0 mm, 450 mm	775-4033-25 C 775-4033 C 775-4033-45 C	775-4033-25 CS 775-4033 CS 775-4033-45 CS
	Biopsy Forceps, with Tooth, Ø 5.0 mm, 250 mm Biopsy Forceps, with Tooth, Ø 5.0 mm, 330 mm Biopsy Forceps, with Tooth, Ø 5.0 mm, 450 mm	775-4032-25 C 775-4032 C 775-4032-45 C	775-4032-25 CS 775-4032 CS 775-4032-45 CS
	Spoon Forceps, Ø 5.0 mm, 250 mm Spoon Forceps, Ø 5.0 mm, 330 mm Spoon Forceps, Ø 5.0 mm, 450 mm	775-4045-25 C 775-4045 C 775-4045-45 C	775-4045-25 CS 775-4045 CS 775-4045-45 CS
	Alligator Biopsy Forceps, Ø 5.0 mm, 250 mm Alligator Biopsy Forceps, Ø 5.0 mm, 330 mm Alligator Biopsy Forceps, Ø 5.0 mm, 450 mm	775-4066-25 C 775-4066 C 775-4066-45 C	775-4066-25 CS 775-4066 CS 775-4066-45 CS



ROTABLE AND DETACHABLE GRASPING FORCEPS



Insulated,
without ratchet.



Insulated,
with ratchet.

	Product Description	Product No.	Product No.
	Dissecting Forceps, Short Serrated, Ø 5.0 mm, 250 mm Dissecting Forceps, Short Serrated, Ø 5.0 mm, 330 mm Dissecting Forceps, Short Serrated, Ø 5.0 mm, 450 mm	775-4086-25 C 775-4086 C 775-4086-45 C	775-4086-25 CS 775-4086 CS 775-4086-45 CS
	Petelin Dissecting Forceps, Slightly Curved, Ø 5.0 mm, 250 mm Petelin Dissecting Forceps, Slightly Curved, Ø 5.0 mm, 330 mm Petelin Dissecting Forceps, Slightly Curved, Ø 5.0 mm, 450 mm	775-4084-25 C 775-4084 C 775-4084-45 C	775-4084-25 CS 775-4084 CS 775-4084-45 CS
	Petelin Dissecting Forceps, Strong Curved, Ø 5.0 mm, 250 mm Petelin Dissecting Forceps, Strong Curved, Ø 5.0 mm, 330 mm Petelin Dissecting Forceps, Strong Curved, Ø 5.0 mm, 450 mm	775-4083-25 C 775-4083 C 775-4083-45 C	775-4083-25 CS 775-4083 CS 775-4083-45 CS
	Dissecting Forceps, Short Curved, Serrated, Ø 5.0 mm, 250 mm Dissecting Forceps, Short Curved, Serrated, Ø 5.0 mm, 330 mm Dissecting Forceps, Short Curved, Serrated, Ø 5.0 mm, 450 mm	775-4085-25 C 775-4085 C 775-4085-45 C	775-4085-25 CS 775-4085 CS 775-4085-45 CS
	Grasping Forceps, Waved, Ø 5.0 mm, 250 mm Grasping Forceps, Waved, Ø 5.0 mm, 330 mm Grasping Forceps, Waved, Ø 5.0 mm, 450 mm	775-4062-25 C 775-4062 C 775-4062-45 C	775-4062-25 CS 775-4062 CS 775-4062-45 CS
	Johan, 20 mm, Serrated Jaws, Ø 5.0 mm, 250 mm Johan, 20 mm, Serrated Jaws, Ø 5.0 mm, 330 mm Johan, 20 mm, Serrated Jaws, Ø 5.0 mm, 450 mm	775-4096-25 C 775-4096 C 775-4096-45 C	775-4096-25 CS 775-4096 CS 775-4096-45 CS
	Johan, 45 mm, Serrated Jaws, Ø 5.0 mm, 250 mm Johan, 45 mm, Serrated Jaws, Ø 5.0 mm, 330 mm Johan, 45 mm, Serrated Jaws, Ø 5.0 mm, 450 mm	775-4097-25 C 775-4097 C 775-4097-45 C	775-4097-25 CS 775-4097 CS 775-4097-45 CS
	Kocher Grasping Forceps, 2 x I Teeth, Ø 5.0 mm, 250 mm Kocher Grasping Forceps, 2 x I Teeth, Ø 5.0 mm, 330 mm Kocher Grasping Forceps, 2 x I Teeth, Ø 5.0 mm, 450 mm	775-4087-25 C 775-4087 C 775-4087-45 C	775-4087-25 CS 775-4087 CS 775-4087-45 CS
	Needle Nose Grasping Forceps, Ø 5.0 mm, 250 mm Needle Nose Grasping Forceps, Ø 5.0 mm, 330 mm Needle Nose Grasping Forceps, Ø 5.0 mm, 450 mm	775-4082-25 C 775-4082 C 775-4082-45 C	775-4082-25 CS 775-4082 CS 775-4082-45 CS
	Claw Grasping Forceps, Ø 5.0 mm, 250 mm Claw Grasping Forceps, Ø 5.0 mm, 330 mm Claw Grasping Forceps, Ø 5.0 mm, 450 mm	775-4043-25 C 775-4043 C 775-4043-45 C	775-4043-25 CS 775-4043 CS 775-4043-45 CS



ROTABLE AND DETACHABLE GRASPING FORCEPS



Insulated,
without ratchet.



Insulated,
with ratchet.

	Product Description	Product No.	Product No.
	Retracting Forceps, Atraumatic Inner Teeth, Ø 5.0 mm, 250 mm Retracting Forceps, Atraumatic Inner Teeth, Ø 5.0 mm, 330 mm Kocher Grasping Forceps, 2 x 1 Teeth, Ø 5.0 mm, 450 mm	775-4093-25 C 775-4093 C 775-4093-45 C	775-4093-25 CS 775-4093 CS 775-4093-45 CS
	Duckbill Grasping Forceps, Ø 5.0 mm, 250 mm Duckbill Grasping Forceps, Ø 5.0 mm, 330 mm Duckbill Grasping Forceps, Ø 5.0 mm, 450 mm	775-4095-25 C 775-4095 C 775-4095-45 C	775-4095-25 CS 775-4095 CS 775-4095-45 CS
	Grasping Forceps, Serrated, Ø 5.0 mm, 250 mm Grasping Forceps, Serrated, Ø 5.0 mm, 330 mm Grasping Forceps, Serrated, Ø 5.0 mm, 450 mm	775-4036-25 C 775-4036 C 775-4036-45 C	775-4036-25 CS 775-4036 CS 775-4036-45 CS
	Biopsy Forceps, Through Cutting, Ø 5.0 mm, 250 mm Biopsy Forceps, Through Cutting, Ø 5.0 mm, 330 mm Biopsy Forceps, Through Cutting, Ø 5.0 mm, 450 mm	775-4067-25 C 775-4067 C 775-4067-45 C	775-4067-25 CS 775-4067 CS 775-4067-45 CS
	Kelly Grasping Forceps, Ø 5.0 mm, 250 mm Kelly Grasping Forceps, Ø 5.0 mm, 330 mm Kelly Grasping Forceps, Ø 5.0 mm, 450 mm	775-4094-25 C 775-4094 C 775-4094-45 C	775-4094-25 CS 775-4094 CS 775-4094-45 CS
	Grasping Forceps with Cup, Pointed, Ø 5.0 mm, 250 mm Grasping Forceps with Cup, Pointed, Ø 5.0 mm, 330 mm Grasping Forceps with Cup, Pointed, Ø 5.0 mm, 450 mm	775-4063-25 C 775-4063 C 775-4063-45 C	775-4063-25 CS 775-4063 CS 775-4063-45 CS
	Grasping Forceps with Cup, Ø 5.0 mm, 250 mm Grasping Forceps with Cup, Ø 5.0 mm, 330 mm Grasping Forceps with Cup, Ø 5.0 mm, 450 mm	775-4038-25 C 775-4038 C 775-4038-45 C	775-4038-25 CS 775-4038 CS 775-4038-45 CS
	Dolphin-Nose Forceps, Short, Ø 5.0 mm, 250 mm Dolphin-Nose Forceps, Short, Ø 5.0 mm, 330 mm Dolphin-Nose Forceps, Short, Ø 5.0 mm, 450 mm	775-4037-25 C 775-4037 C 775-4037-45 C	775-4037-25 CS 775-4037 CS 775-4037-45 CS
	Grasping Forceps, Curved, Ø 5.0 mm, 250 mm Grasping Forceps, Curved, Ø 5.0 mm, 330 mm Grasping Forceps, Curved, Ø 5.0 mm, 450 mm	775-4080-25 C 775-4080 C 775-4080-45 C	775-4080-25 CS 775-4080 CS 775-4080-45 CS



ROTABLE AND DETACHABLE GRASPING FORCEPS



Insulated,
without ratchet.



Insulated,
with ratchet.

	Product Description	Product No.	Product No.
	Grasping Forceps, Serrated, Ø 5.0 mm, 250 mm Grasping Forceps, Serrated, Ø 5.0 mm, 330 mm Grasping Forceps, Serrated, Ø 5.0 mm, 450 mm	775-4225-25 C 775-4225 C 775-4225-45 C	775-4225-25 CS 775-4225 CS 775-4225-45 CS
	Multiple Grasping Forceps, Ø 5.0 mm, 250 mm Multiple Grasping Forceps, Ø 5.0 mm, 330 mm Multiple Grasping Forceps, Ø 5.0 mm, 450 mm	775-4090-25 C 775-4090 C 775-4090-45 C	775-4090-25 CS 775-4090 CS 775-4090-45 CS
	Forceps, Smooth, Ø 5.0 mm, 250 mm Forceps, Smooth, Ø 5.0 mm, 330 mm Forceps, Smooth, Ø 5.0 mm, 450 mm	775-4035-25 C 775-4035 C 775-4035-45 C	775-4035-25 CS 775-4035 CS 775-4035-45 CS
	Fundus Grasping Forceps, with Teeth, Ø 5.0 mm, 250 mm Fundus Grasping Forceps, with Teeth, Ø 5.0 mm, 330 mm Fundus Grasping Forceps, with Teeth, Ø 5.0 mm, 450 mm	775-4074-25 C 775-4074 C 775-4074-45 C	775-4074-25 CS 775-4074 CS 775-4074-45 CS
	Grasping Forceps, Long, Ø 5.0 mm, 250 mm Grasping Forceps, Long, Ø 5.0 mm, 330 mm Grasping Forceps, Long, Ø 5.0 mm, 450 mm	775-4076-25 C 775-4076 C 775-4076-45 C	775-4076-25 CS 775-4076 CS 775-4076-45 CS
	Mini Grasping Forceps, Fenestrated, Ø 5.0 mm, 250 mm Mini Grasping Forceps, Fenestrated, Ø 5.0 mm, 330 mm Mini Grasping Forceps, Fenestrated, Ø 5.0 mm, 450 mm	775-4079-25 C 775-4079 C 775-4079-45 C	775-4079-25 CS 775-4079 CS 775-4079-45 CS
	Grasping Forceps, Serrated with Window, Ø 5.0 mm, 250 mm Grasping Forceps, Serrated with Window, Ø 5.0 mm, 330 mm Grasping Forceps, Serrated with Window, Ø 5.0 mm, 450 mm	775-4068-25 C 775-4068 C 775-4068-45 C	775-4068-25 CS 775-4068 CS 775-4068-45 CS
	Grasping Forceps, Strong Teeth, Ø 5.0 mm, 250 mm Grasping Forceps, Strong Teeth, Ø 5.0 mm, 330 mm Grasping Forceps, Strong Teeth, Ø 5.0 mm, 450 mm	775-4081-25 C 775-4081 C 775-4081-45 C	775-4081-25 CS 775-4081 CS 775-4081-45 CS











ROTABLE AND DETACHABLE GRASPING FORCEPS



Insulated,
without ratchet.



Insulated,
with ratchet.

	Product Description	Product No.	Product No.
	Debakey, Atraumatic, 20 mm Jaw Length, Ø 5.0 mm, 250 mm Debakey, Atraumatic, 20 mm Jaw Length, Ø 5.0 mm, 330 mm Debakey, Atraumatic, 20 mm Jaw Length, Ø 5.0 mm, 450 mm	775-4099-25 C 775-4099 C 775-4099-45 C	775-4099-25 CS 775-4099 CS 775-4099-45 CS
	Debakey, Atraumatic, 30 mm Jaw Length, Ø 5.0 mm, 250 mm Debakey, Atraumatic, 30 mm Jaw Length, Ø 5.0 mm, 330 mm Debakey, Atraumatic, 30 mm Jaw Length, Ø 5.0 mm, 450 mm	775-4100-25 C 775-4100 C 775-4100-45 C	775-4100-25 CS 775-4100 CS 775-4100-45 CS
	Debakey, Atraumatic, 40 mm Jaw Length, Ø 5.0 mm, 250 mm Debakey, Atraumatic, 40 mm Jaw Length, Ø 5.0 mm, 330 mm Debakey, Atraumatic, 40 mm Jaw Length, Ø 5.0 mm, 450 mm	775-4101-25 C 775-4101 C 775-4101-45 C	775-4101-25 CS 775-4101 CS 775-4101-45 CS
	Debakey, Atraumatic, 50 mm Jaw Length, Ø 5.0 mm, 250 mm Debakey, Atraumatic, 50 mm Jaw Length, Ø 5.0 mm, 330 mm Debakey, Atraumatic, 50 mm Jaw Length, Ø 5.0 mm, 450 mm	775-4249-25 C 775-4249 C 775-4249-45 C	775-4249-25 CS 775-4249 CS 775-4249-45 CS
	Kocher, Serrated Lengthwise, 40 mm Jaw Length, Ø 5.0 mm, 250 mm Kocher, Serrated Lengthwise, 40 mm Jaw Length, Ø 5.0 mm, 330 mm Kocher, Serrated Lengthwise, 40 mm Jaw Length, Ø 5.0 mm, 450 mm	775-4236-25 C 775-4236 C 775-4236-45 C	775-4236-25 CS 775-4236 CS 775-4236-45 CS
	Kocher, Serrated Lengthwise, 60 mm Jaw Length, Ø 5.0 mm, 250 mm Kocher, Serrated Lengthwise, 60 mm Jaw Length, Ø 5.0 mm, 330 mm Kocher, Serrated Lengthwise, 60 mm Jaw Length, Ø 5.0 mm, 450 mm	775-4235-25 C 775-4235 C 775-4235-45 C	775-4235-25 CS 775-4235 CS 775-4235-45 CS
	Strong Grasping Forceps, Atraumatic, Ø 5.0 mm, 250 mm Strong Grasping Forceps, Atraumatic, Ø 5.0 mm, 330 mm Strong Grasping Forceps, Atraumatic, Ø 5.0 mm, 450 mm	775-4232-25 C 775-4232 C 775-4232-45 C	775-4232-25 CS 775-4232 CS 775-4232-45 CS
	Glassmann Grasping Forceps, Atraumatic, Ø 5.0 mm, 250 mm Glassmann Grasping Forceps, Atraumatic, Ø 5.0 mm, 330 mm Glassmann Grasping Forceps, Atraumatic, Ø 5.0 mm, 450 mm	775-4091-25 C 775-4091 C 775-4091-45 C	775-4091-25 CS 775-4091 CS 775-4091-45 CS











ROTABLE AND DETACHABLE GRASPING FORCEPS



Insulated,
without ratchet.



Insulated,
with ratchet.

	Product Description	Product No.	Product No.
	Strong Grasping Forceps, Atraumatic, Ø 5.0 mm, 250 mm Strong Grasping Forceps, Atraumatic, Ø 5.0 mm, 330 mm Strong Grasping Forceps, Atraumatic, Ø 5.0 mm, 450 mm	775-4230-25 C 775-4230 C 775-4230-45 C	775-4230-25 CS 775-4230 CS 775-4230-45 CS
	Fundus Grasping Forceps, Ø 5.0 mm, 250 mm Fundus Grasping Forceps, Ø 5.0 mm, 330 mm Fundus Grasping Forceps, Ø 5.0 mm, 450 mm	775-4073-25 C 775-4073 C 775-4073-45 C	775-4073-25 CS 775-4073 CS 775-4073-45 CS
	Grasping Forceps, Waved with Pocket, Ø 5.0 mm, 250 mm Grasping Forceps, Waved with Pocket, Ø 5.0 mm, 330 mm Grasping Forceps, Waved with Pocket, Ø 5.0 mm, 450 mm	775-4072-25 C 775-4072 C 775-4072-45 C	775-4072-25 CS 775-4072 CS 775-4072-45 CS
	Endo Clinch, Atraumatic Serrated, Ø 5.0 mm, 250 mm Endo Clinch, Atraumatic Serrated, Ø 5.0 mm, 330 mm Endo Clinch, Atraumatic Serrated, Ø 5.0 mm, 450 mm	775-4089-25 C 775-4089 C 775-4089-45 C	775-4089-25 CS 775-4089 CS 775-4089-45 CS
	Grasping Forceps, 2 x 3 Teeth, Ø 5.0 mm, 250 mm Grasping Forceps, 2 x 3 Teeth, Ø 5.0 mm, 330 mm Grasping Forceps, 2 x 3 Teeth, Ø 5.0 mm, 450 mm	775-4065-25 C 775-4065 C 775-4065-45 C	775-4065-25 CS 775-4065 CS 775-4065-45 CS
	Grasping Forceps, 3 x 4 Teeth, Smooth, Ø 5.0 mm, 250 mm Grasping Forceps, 3 x 4 Teeth, Smooth, Ø 5.0 mm, 330 mm Grasping Forceps, 3 x 4 Teeth, Smooth, Ø 5.0 mm, 450 mm	775-4078-25 C 775-4078 C 775-4078-45 C	775-4078-25 CS 775-4078 CS 775-4078-45 CS
	Schroeder Hook Forceps, Sharp Teeth, Ø 5.0 mm, 250 mm Schroeder Hook Forceps, Sharp Teeth, Ø 5.0 mm, 330 mm Schroeder Hook Forceps, Sharp Teeth, Ø 5.0 mm, 450 mm	775-4244-25 C 775-4244 C 775-4244-45 C	775-4244-25 CS 775-4244 CS 775-4244-45 CS
	Knot Tier, Ø 5.0 mm, 250 mm Knot Tier, Ø 5.0 mm, 330 mm Knot Tier, Ø 5.0 mm, 450 mm	775-190-25 C 775-190 C 775-190-45 C	775-109-25 CS 775-109 CS 775-109-45 CS



ROTABLE AND DETACHABLE GRASPING FORCEPS



Insulated,
without ratchet.



Insulated,
with ratchet.

	Product Description	Product No.	Product No.
	Grasping Forceps, Pointed, Atraumatic, Ø 5.0 mm, 250 mm Grasping Forceps, Pointed, Atraumatic, Ø 5.0 mm, 330 mm Grasping Forceps, Pointed, Atraumatic, Ø 5.0 mm, 450 mm	775-4064-25 C 775-4064 C 775-4064-45 C	775-4064-25 CS 775-4064 CS 775-4064-45 CS
	Maryland, Coarse Serrated, Curved, Ø 5.0 mm, 250 mm Maryland, Coarse Serrated, Curved, Ø 5.0 mm, 330 mm Maryland, Coarse Serrated, Curved, Ø 5.0 mm, 450 mm	775-4069-25 C 775-4069 C 775-4069-45 C	775-4069-25 CS 775-4069 CS 775-4069-45 CS
	Maryland Grasping Forceps, Fine Serrated, Ø 5.0 mm, 250 mm Maryland Grasping Forceps, Fine Serrated, Ø 5.0 mm, 330 mm Maryland Grasping Forceps, Fine Serrated, Ø 5.0 mm, 450 mm	775-4021-25 C 775-4021 C 775-4021-45 C	775-4021-25 CS 775-4021 CS 775-4021-45 CS
	Maryland Grasping Forceps, Coarse Serrated, Ø 5.0 mm, 250 mm Maryland Grasping Forceps, Coarse Serrated, Ø 5.0 mm, 330 mm Maryland Grasping Forceps, Coarse Serrated, Ø 5.0 mm, 450 mm	775-4020-25 C 775-4020 C 775-4020-45 C	775-4020-25 CS 775-4020 CS 775-4020-45 CS
	Maryland, Cross Serrated, Ø 5.0 mm, 250 mm Maryland, Cross Serrated, Ø 5.0 mm, 330 mm Maryland, Cross Serrated, Ø 5.0 mm, 450 mm	775-4075-25 C 775-4075 C 775-4075-45 C	775-4075-25 CS 775-4075 CS 775-4075-45 CS
	Maryland Debakey, Curved, Ø 5.0 mm, 250 mm Maryland Debakey, Curved, Ø 5.0 mm, 330 mm Maryland Debakey, Curved, Ø 5.0 mm, 450 mm	775-4088-25 C 775-4088 C 775-4088-45 C	775-4088-25 CS 775-4088 CS 775-4088-45 CS
	Mixer Grasping Forceps, 45° Angled, Ø 5.0 mm, 250 mm Mixer Grasping Forceps, 45° Angled, Ø 5.0 mm, 330 mm Mixer Grasping Forceps, 45° Angled, Ø 5.0 mm, 450 mm	775-4228-25 C 775-4228 C 775-4228-45 C	775-4228-25 CS 775-4228 CS 775-4228-45 CS
	Mixer Grasping Forceps, 45° Curved, Ø 5.0 mm, 250 mm Mixer Grasping Forceps, 45° Curved, Ø 5.0 mm, 330 mm Mixer Grasping Forceps, 45° Curved, Ø 5.0 mm, 450 mm	775-4222-25 C 775-4222 C 775-4222-45 C	775-4222-25 CS 775-4222 CS 775-4222-45 CS



ROTABLE AND DETACHABLE GRASPING FORCEPS



Insulated,
without ratchet.



Insulated,
with ratchet.

	Product Description	Product No.	Product No.
	Mixer Grasping Forceps, 90° Angled, Ø 5.0 mm, 250 mm Mixer Grasping Forceps, 90° Angled, Ø 5.0 mm, 330 mm Mixer Grasping Forceps, 90° Angled, Ø 5.0 mm, 450 mm	775-4092-25 C 775-4092 C 775-4092-45 C	775-4092-25 CS 775-4092 CS 775-4092-45 CS
	Collin Grasping Forceps, Ø 5.0 mm, 250 mm Collin Grasping Forceps, Ø 5.0 mm, 330 mm Collin Grasping Forceps, Ø 5.0 mm, 450 mm	775-4046-25 C 775-4046 C 775-4046-45 C	775-4046-25 CS 775-4046 CS 775-4046-45 CS
	Duval Grasping Forceps, Ø 5.0 mm, 250 mm Duval Grasping Forceps, Ø 5.0 mm, 330 mm Duval Grasping Forceps, Ø 5.0 mm, 450 mm	775-4233-25 C 775-4233 C 775-4233-45 C	775-4233-25 CS 775-4233 CS 775-4233-45 CS
	TC-Collin Grasping Forceps, Cross Serrated, Ø 5.0 mm, 250 mm TC-Collin Grasping Forceps, Cross Serrated, Ø 5.0 mm, 330 mm TC-Collin Grasping Forceps, Cross Serrated, Ø 5.0 mm, 450 mm	775-4234-25 C 775-4234 C 775-4234-45 C	775-4234-25 CS 775-4234 CS 775-4234-45 CS
	Pennington Grasping Forceps, Ø 5.0 mm, 250 mm Pennington Grasping Forceps, Ø 5.0 mm, 330 mm Pennington Grasping Forceps, Ø 5.0 mm, 450 mm	775-4224-25 C 775-4224 C 775-4224-45 C	775-4224-25 CS 775-4224 CS 775-4224-45 CS
	Babcock Forceps, Ø 5.0 mm, 250 mm Babcock Forceps, Ø 5.0 mm, 330 mm Babcock Forceps, Ø 5.0 mm, 450 mm	775-4098-25 C 775-4098 C 775-4098-45 C	775-4098-25 CS 775-4098 CS 775-4098-45 CS
	Allis Grasping Forceps, 45° Angled, Ø 5.0 mm, 250 mm Allis Grasping Forceps, 45° Angled, Ø 5.0 mm, 330 mm Allis Grasping Forceps, 45° Angled, Ø 5.0 mm, 450 mm	775-4229-25 C 775-4229 C 775-4229-45 C	775-4229-25 CS 775-4229 CS 775-4229-45 CS
	Grasping Forceps, Cross Serrated, Ø 5.0 mm, 250 mm Grasping Forceps, Cross Serrated, Ø 5.0 mm, 330 mm Grasping Forceps, Cross Serrated, Ø 5.0 mm, 450 mm	775-4242-25 C 775-4242 C 775-4242-45 C	775-4242-25 CS 775-4242 CS 775-4242-45 CS











ROTABLE AND DETACHABLE GRASPING FORCEPS



Insulated,
without ratchet.



Insulated,
with ratchet.

	Product Description	Product No.	Product No.
	Allis Grasping Forceps, Cross Serrated, Ø 5.0 mm, 250 mm Allis Grasping Forceps, Cross Serrated, Ø 5.0 mm, 330 mm Allis Grasping Forceps, Cross Serrated, Ø 5.0 mm, 450 mm	775-5070-25 C 775-5070 C 775-5070-45 C	775-5070-25 CS 775-5070 CS 775-5070-45 CS
	Grasping Forceps, Atraumatic, T-Form, Ø 5.0 mm, 250 mm Grasping Forceps, Atraumatic, T-Form, Ø 5.0 mm, 330 mm Grasping Forceps, Atraumatic, T-Form, Ø 5.0 mm, 450 mm	775-4231-25 C 775-4046 C 775-4046-45 C	775-4231-25 CS 775-4046 CS 775-4046-45 CS
	Debakey Grasping Forceps, Atraumatic, Ø 5.0 mm, 250 mm Debakey Grasping Forceps, Atraumatic, Ø 5.0 mm, 330 mm Debakey Grasping Forceps, Atraumatic, Ø 5.0 mm, 450 mm	775-4226-25 C 775-4226 C 775-4226-45 C	775-4226-25 CS 775-4226 CS 775-4226-45 CS
	Allis Grasping Forceps, Serrated Lengthwise, Ø 5.0 mm, 250 mm Allis Grasping Forceps, Serrated Lengthwise, Ø 5.0 mm, 330 mm Allis Grasping Forceps, Serrated Lengthwise, Ø 5.0 mm, 450 mm	775-4071-25 C 775-4071 C 775-4071-45 C	775-4071-25 CS 775-4071 CS 775-4071-45 CS
	Allis Grasping Forceps, Ø 5.0 mm, 250 mm Allis Grasping Forceps, Ø 5.0 mm, 330 mm Allis Grasping Forceps, Ø 5.0 mm, 450 mm	775-4241-25 C 775-4241 C 775-4241-45 C	775-4241-25 CS 775-4241 CS 775-4241-45 CS
	Grasping Forceps, Atraumatic, Pointed, Ø 5.0 mm, 250 mm Grasping Forceps, Atraumatic, Pointed, Ø 5.0 mm, 330 mm Grasping Forceps, Atraumatic, Pointed, Ø 5.0 mm, 450 mm	775-4164-25 C 775-4164 C 775-4164-45 C	775-4164-25 CS 775-4164 CS 775-4164-45 CS
	Maryland Grasping Forceps, Curved, Ø 5.0 mm, 250 mm Maryland Grasping Forceps, Curved, Ø 5.0 mm, 330 mm Maryland Grasping Forceps, Curved, Ø 5.0 mm, 450 mm	775-4169-25 C 775-4169 C 775-4169-45 C	775-4169-25 CS 775-4169 CS 775-4169-45 CS
	Maryland Grasping Forceps, Fine, Curved, Ø 5.0 mm, 250 mm Maryland Grasping Forceps, Fine, Curved, Ø 5.0 mm, 330 mm Maryland Grasping Forceps, Fine, Curved, Ø 5.0 mm, 450 mm	775-4175-25 C 775-4175 C 775-4175-45 C	775-4175-25 CS 775-4175 CS 775-4175-45 CS
	Grasping Forceps, Long, Ø 5.0 mm, 250 mm Grasping Forceps, Long, Ø 5.0 mm, 330 mm Grasping Forceps, Long, Ø 5.0 mm, 450 mm	775-4176-25 C 775-4176 C 775-4176-45 C	775-4176-25 CS 775-4176 CS 775-4176-45 CS



CLIP APPLICATION FORCEPS

Detachable, 360° Rotatable for Titanium Clips



Product Description

Ø 5.0 mm, For Small Ethicon Type Clips, Ø 5.0 mm - 330 mm
Ø 6.5 mm, For Medium Ethicon Type Clips, Ø 5.0 mm - 330 mm

Product No.

708-680
708-681

Detachable, 360° Rotatable for Titanium Clips, with LL- Channel

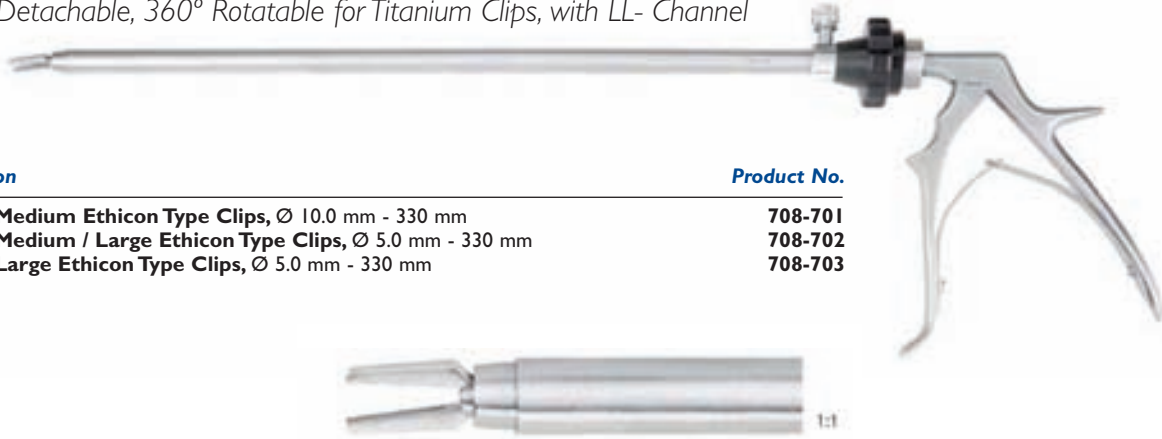

Product Description

Ø 12.5 mm, For Medium Ethicon Type Clips, Ø 10.0 mm - 330 mm
Ø 12.5 mm, For Medium / Large Ethicon Type Clips, Ø 5.0 mm - 330 mm
Ø 12.5 mm, For Large Ethicon Type Clips, Ø 5.0 mm - 330 mm

Product No.

708-701
708-702
708-703

CHOLANGIOGRAPHY FORCEPS FOR CATHETERS

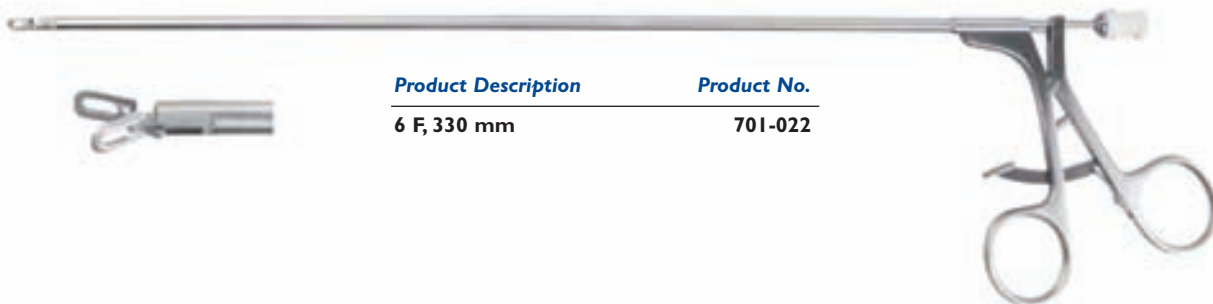

Product Description

6 F, 330 mm

Product No.

701-022



NEEDLE HOLDERS

AXIAL HANDLES

- Ergonomically designed handle allows for more efficient handling of needles and sutures
- LL Rinsing Channel

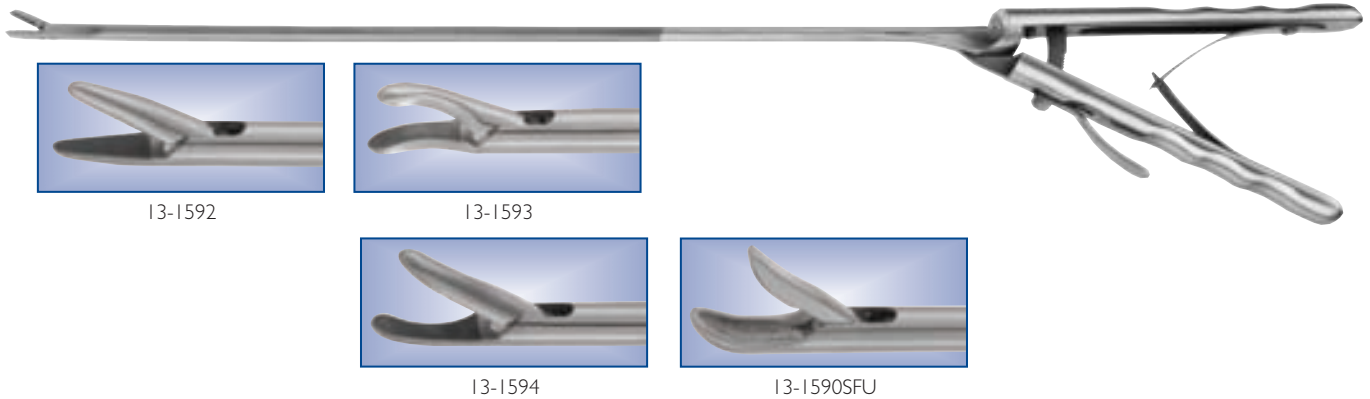

Product Description	Product No.
TC Insert Jaw, Straight, Axial Handle, 5 mm, OD, 32 cm L	13-1592
TC Insert Jaw, Right Curved, Axial Handle, 5 mm, OD, 32 cm L	13-1593
TC Insert Jaw, Left Curved, Axial Handle, 5 mm, OD, 32 cm L	13-1594
TC Insert Jaw, Romeo Style, Axial Handle, 5 mm, OD, 32 cm L	13-1590SFU

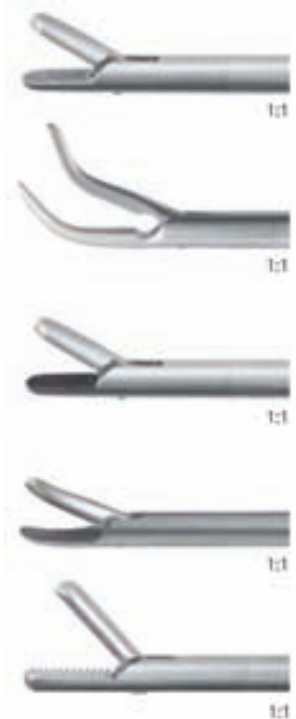
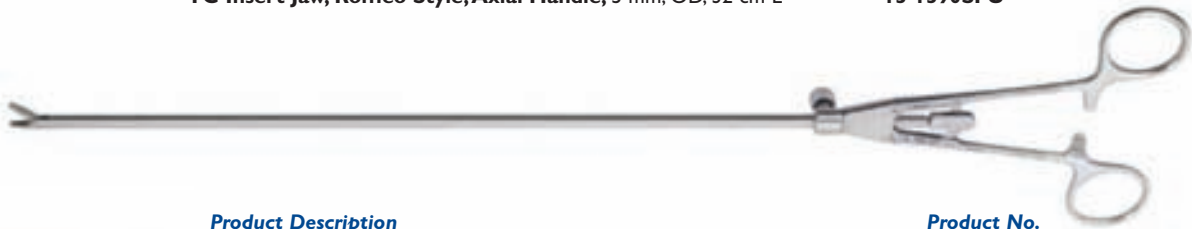

Product Description	Product No.
Cross Serrated Jaw, Straight, Ø 5.0 mm - 320 mm	708-100 LL

Product Description	Product No.
Cross Serrated Jaw, Straight, Tekno-Flam, Ø 5.0 mm - 320 mm	708-110 LL

Product Description	Product No.
Cross Serrated Jaw, with TC-Inserts, Straight, Ø 5.0 mm - 320 mm	708-511 LL

Product Description	Product No.
Cross Serrated Jaw, with TC-Inserts, Curved, Ø 5.0 mm - 320 mm	708-512 LL

Product Description	Product No.
Jaw Diamond Coated, Automatic Needle positioning, Ø 5.0 mm - 320 mm	708-530



KNOT PUSHERS



Closed

Product Description

Product No.

Knot Pusher with Eyelet, 5 mm, 33 cm **17.003.33**
Knot Pusher with Eyelet, 5 mm, 45 cm **17.003.45**



Open

Product Description

Product No.

Knot Pusher with Slit, 5 mm **17.002.33**
Knot Pusher with Slit, 5 mm, 45 cm **17.002.45**

FAN RETRACTORS

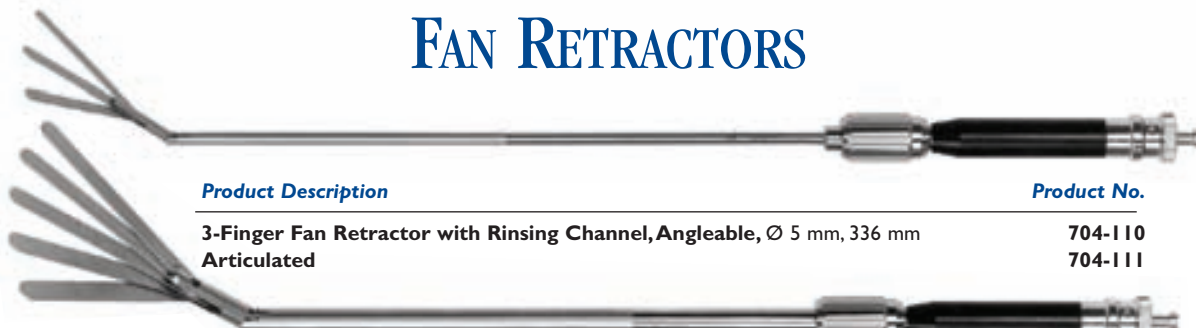

Product Description

Product No.

3-Finger Fan Retractor with Rinsing Channel, Angleable, Ø 5 mm, 336 mm **704-110**
Articulated **704-111**



Product Description

Product No.

5-Finger Fan Retractor with Rinsing Channel, Angleable, Ø 10 mm, 347 mm **704-112**
Articulated **13-1672**

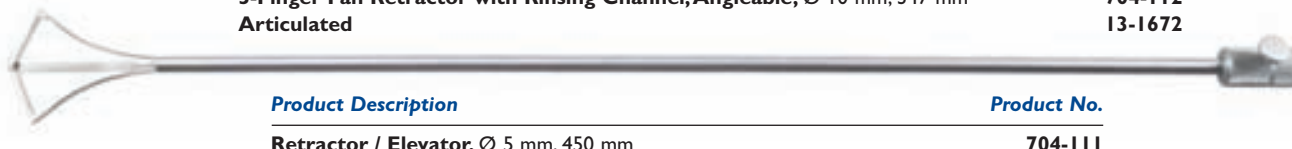

Product Description

Product No.

Retractor / Elevator, Ø 5 mm, 450 mm **704-111**

ELECTRODES WITH HANDLES

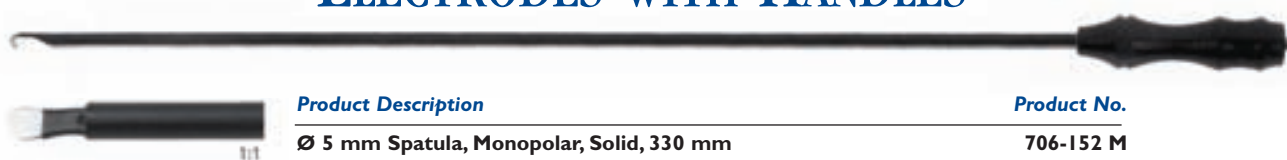

Product Description

Product No.

Ø 5 mm Spatula, Monopolar, Solid, 330 mm **706-152 M**



Product Description

Product No.

Ø 5 mm Hook, Monopolar, Solid, 330 mm **706-154 M**



Product Description

Product No.

Ø 5 mm, 90° Hook, Monopolar, Solid, 330 mm **706-156 M**



Product Description

Product No.

Ø 5 mm Ball Point, Monopolar, Solid, 330 mm **706-158 M**





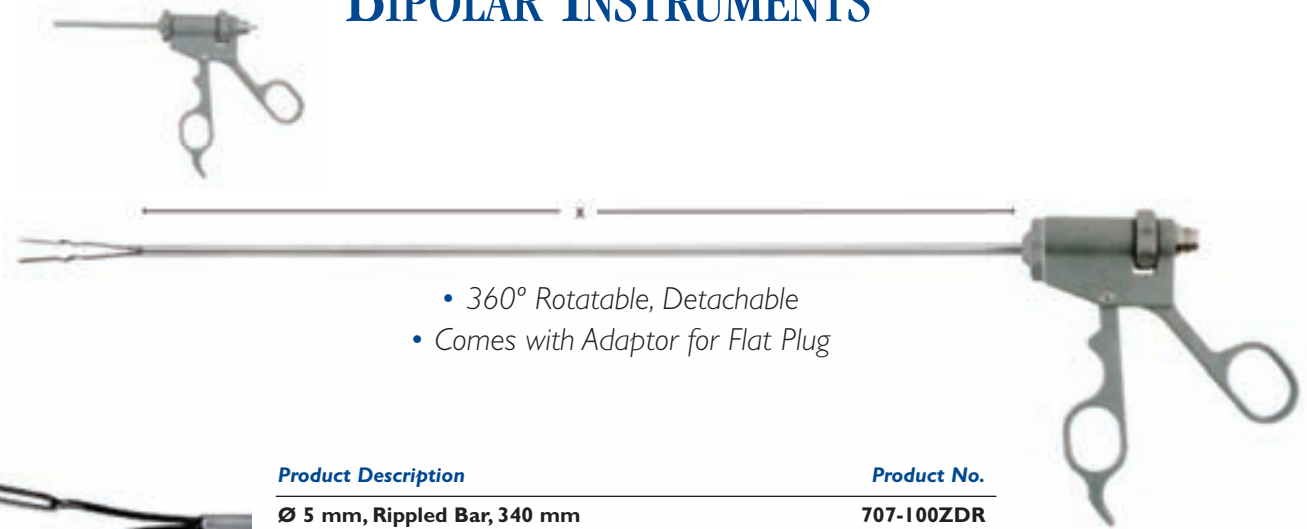

BIPOLAR INSTRUMENTS



- 360° Rotatable, Detachable
- Comes with Adaptor for Flat Plug

	Product Description	Product No.
	Ø 5 mm, Rippled Bar, 340 mm	707-100ZDR
	Product Description	Product No.
	Ø 5 mm, Tong-Type Jaw, 340 mm	707-101ZDR
	Product Description	Product No.
	Ø 5 mm, Fluted Tip, 340 mm	707-103ZDR
	Product Description	Product No.
	Ø 5 mm, Scissor, Curved, 340 mm	707-105ZDR
	Product Description	Product No.
	Ø 5 mm, Scissor with TC-Blades, Curved, 340 mm	707-106ZDR
	Product Description	Product No.
	Ø 5 mm, Kleppinger Grasper, Serrated, 340 mm	707-108ZDR
	Product Description	Product No.
	Ø 5 mm, Maryland Dissector, Curved, 340 mm	707-109ZDR

BIPOLAR COAGULATION ELECTRODES

	Product Description	Product No.
	Ø 5 mm, Hook, 340 mm	707-150
	Product Description	Product No.
	Ø 5 mm, 90° Hook, 340 mm	707-151
	Product Description	Product No.
	Ø 5 mm, Spatula, 340 mm	707-152
	Product Description	Product No.
	Ø 5 mm, Ball Point, 340 mm	707-153



Accessories

HIGH FREQUENCY MONOPOLAR CABLE



For Units:	Units / Instrument Side	Length	Product No.
Tekno, Berchtold, Martin, Erbe T-Series	4 mm / 4 mm	3 mm	707-510
	male / male	5 mm	707-511
Tekno, Storz, Erbe, Martin, Berchtold	4 mm / 4 mm	3 mm	707-520
	male / male	5 mm	707-521
Tekno, Valleylab	8 mm / 4 mm male / male	3 mm	707-525

Autoclavable 273°

BIPOLAR CABLES



Units:	Size	Instrument Side	Product No.
Erbe, ICC / ACC,, Wisap, Storz	3 mm	Flat Plug, Round	707-330
	3 mm	Flat Plug, Square	707-300
Martin, Berchtold	3 mm	Flat Plug, Round	707-331
	3 mm	Flat Plug, Square	707-301
Tekno, Valleylab	3 mm	Flat Plug, Round	707-332
	3 mm	Flat Plug, Square	707-302
Tekno, Valleylab Europe	3 mm	Flat Plug, Round	707-332
	3 mm	Flat Plug, Square	707-302



Autoclavable 273°

CLEANING & STERILIZATION ACCESSORIES







Product Description	Product No.
Cleaning Gun with 9 Adaptors	706-600
For Ø 5 mm Tube, Cleaning Brush, 490 mm, (10 pieces)	706-605
For Ø 10 mm Tube, Cleaning Brush, 490 mm, (10 pieces)	706-610



Product Description	Product No.
Sterilization Tray for Laparoscopy Instruments	87295-00
Fittings: 5 x Ø 5 mm and 5 x Ø 10 mm (Wire Basket not included)	
Wire Basket, 540 x 250 x 30 mm (For 87295-00)	87295-00
Container (For 87295-00)	87295-00

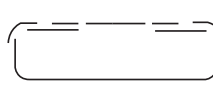
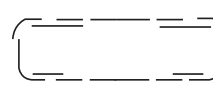
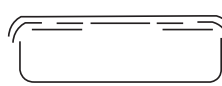
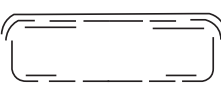

CONTAINERS & MATCHING TRAYS

<i>Container Models & Dimensions</i>	Perforated Lid Unperforated Bottom	Perforated Lid Perforated Bottom	Safety Lid Unperforated Bottom	Safety Lid Perforated Bottom
<p>580 x 280 x 100 mm</p> 	 <ul style="list-style-type: none"> R 110.10 R 120.10 R 130.10 R 140.10 R 150.10 	 <ul style="list-style-type: none"> R 111.10 R 121.10 R 131.10 R 141.10 R 151.10 	 <ul style="list-style-type: none"> R 112.10 R 122.10 R 132.10 R 142.10 R 152.10 	 <ul style="list-style-type: none"> R 113.10 R 123.10 R 133.10 R 143.10 R 153.10
<p>580 x 280 x 135 mm</p> 	<ul style="list-style-type: none"> R 110.13 R 120.13 R 130.13 R 140.13 R 150.13 	<ul style="list-style-type: none"> R 111.13 R 121.13 R 131.13 R 141.13 R 151.13 	<ul style="list-style-type: none"> R 112.13 R 122.13 R 132.13 R 142.13 R 152.13 	<ul style="list-style-type: none"> R 113.13 R 123.13 R 133.13 R 143.13 R 153.13
<p>580 x 280 x 150 mm</p> 	<ul style="list-style-type: none"> R 110.15 R 120.15 R 130.15 R 140.15 R 150.15 	<ul style="list-style-type: none"> R 111.15 R 121.15 R 131.15 R 141.15 R 151.15 	<ul style="list-style-type: none"> R 112.15 R 122.15 R 132.15 R 142.15 R 152.15 	<ul style="list-style-type: none"> R 113.15 R 123.15 R 133.15 R 143.15 R 153.15
<p>580 x 280 x 200 mm</p> 	<ul style="list-style-type: none"> R 110.20 R 120.20 R 130.20 R 140.20 R 150.20 	<ul style="list-style-type: none"> R 111.20 R 121.20 R 131.20 R 141.20 R 151.20 	<ul style="list-style-type: none"> R 112.20 R 122.20 R 132.20 R 142.20 R 152.20 	<ul style="list-style-type: none"> R 113.20 R 123.20 R 133.20 R 143.20 R 153.20
<p>580 x 280 x 260 mm</p> 	<ul style="list-style-type: none"> R 110.26 R 120.26 R 130.26 R 140.26 R 150.26 	<ul style="list-style-type: none"> R 111.26 R 121.26 R 131.26 R 141.26 R 151.26 	<ul style="list-style-type: none"> R 112.26 R 122.26 R 132.26 R 142.26 R 152.26 	<ul style="list-style-type: none"> R 113.26 R 123.26 R 133.26 R 143.26 R 153.26



<i>Container Models & Dimensions</i>	Perforated Lid	Perforated Lid Perforated Bottom	Safety Lid Unperforated Bottom	Safety Lid Perforated Bottom
<p>285 x 280 x 100 mm</p> 	<p>R 310.10</p> <p>R 320.10</p> <p>R 330.10</p> <p>R 340.10</p> <p>R 350.10</p>	<p>R 311.10</p> <p>R 321.10</p> <p>R 331.10</p> <p>R 341.10</p> <p>R 351.10</p>	<p>R 312.10</p> <p>R 322.10</p> <p>R 332.10</p> <p>R 342.10</p> <p>R 352.10</p>	<p>R 313.10</p> <p>R 323.10</p> <p>R 333.10</p> <p>R 343.10</p> <p>R 353.10</p>
<p>285 x 280 x 135 mm</p> 	<p>R 310.13</p> <p>R 320.13</p> <p>R 330.13</p> <p>R 340.13</p> <p>R 350.13</p>	<p>R 311.13</p> <p>R 321.13</p> <p>R 331.13</p> <p>R 341.13</p> <p>R 351.13</p>	<p>R 312.13</p> <p>R 322.13</p> <p>R 332.13</p> <p>R 342.13</p> <p>R 352.13</p>	<p>R 313.13</p> <p>R 323.13</p> <p>R 333.13</p> <p>R 343.13</p> <p>R 353.13</p>
<p>285 x 280 x 150 mm</p> 	<p>R 310.15</p> <p>R 320.15</p> <p>R 330.15</p> <p>R 340.15</p> <p>R 350.15</p>	<p>R 311.15</p> <p>R 321.15</p> <p>R 331.15</p> <p>R 341.15</p> <p>R 351.15</p>	<p>R 312.15</p> <p>R 322.15</p> <p>R 332.15</p> <p>R 342.15</p> <p>R 352.15</p>	<p>R 313.15</p> <p>R 323.15</p> <p>R 333.15</p> <p>R 343.15</p> <p>R 353.15</p>
<p>285 x 280 x 200 mm</p> 	<p>R 310.20</p> <p>R 320.20</p> <p>R 330.20</p> <p>R 340.20</p> <p>R 350.20</p>	<p>R 311.20</p> <p>R 321.20</p> <p>R 331.20</p> <p>R 341.20</p> <p>R 351.20</p>	<p>R 312.20</p> <p>R 322.20</p> <p>R 332.20</p> <p>R 342.20</p> <p>R 352.20</p>	<p>R 313.20</p> <p>R 323.20</p> <p>R 333.20</p> <p>R 343.20</p> <p>R 353.20</p>
<p>285 x 280 x 260 mm</p> 	<p>R 310.26</p> <p>R 320.26</p> <p>R 330.26</p> <p>R 340.26</p> <p>R 350.26</p>	<p>R 311.26</p> <p>R 321.26</p> <p>R 331.26</p> <p>R 341.26</p> <p>R 351.26</p>	<p>R 312.26</p> <p>R 322.26</p> <p>R 332.26</p> <p>R 342.26</p> <p>R 352.26</p>	<p>R 313.26</p> <p>R 323.26</p> <p>R 333.26</p> <p>R 343.26</p> <p>R 353.26</p>



300 x 138 x 65 mm

Perforated Lid
Perforated Bottom (without filter)

- R 610.06
- R 620.06
- R 630.06
- R 640.06
- R 650.06

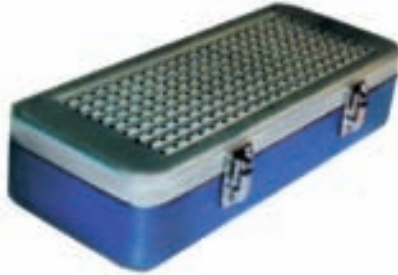

500 x 155 x 75 mm

Perforated Lid
Perforated Bottom (without filter)

- R 612.07
- R 622.07
- R 632.07
- R 642.07
- R 652.07



Instrument Identification

Tape in rolls

Color *Product No.*

White **151-001**

Blue **151-002**

Kelly Green **151-003**

Red **151-004**

Yellow **151-005**

Purple **151-006**

Orange **151-007**

Black **151-009**



VASECTOMY SETS

Video available showing "No-Scalpel" technique



WILSON VAS SET

<i>Product Description</i>	<i>Product No.</i>
Wilson Vasectomy Clamp Set of 2	382-300
Wilson Vasectomy Elevation Clamp	382-301
Wilson Vasectomy Dissecting Clamp	382-302



<i>Product Description</i>	<i>Product No.</i>
Vasectomy Clamp Set of 2	382-200
Vasectomy Ring Clamp, Gold Handle	382-201
Vasectomy Dissector, Gold Handle	382-202



Big Savings & Big Rewards!

By joining the Preferred Customer Club program, you get savings, you get big rewards & benefits that make a big difference to your practice. As a cardmember, you'll be offered:

- Special Savings & discounts on Instruments
- Instruments on Demand with priority ordering
- Monthly statements & reports - on paper & online - that consolidate all of your balance points
- Extended warranty and purchase security coverage on all purchases
- Specialized Newsletter with information related to your preferences
- Special promos for shows oriented exclusively to Marina Medical Preferred Customer Club members
- Buy online by using our website: www.marinamedical.com
- Redeem your points online
- Order your instruments online for your next show, and simply pick up those instruments directly from our booth
- Review our show schedule online to receive additional discounts when you visit our booth



Join the Marina Medical
PREFERRED CUSTOMER CLUB
And start earning valuable rewards
Ask Your Rep Now

Earn Valuable Reward Points on all of Your Marina Medical Purchases and choose from Rewards like:

- FREE Instruments**
 - FREE Repairs
- **FREE Engraving Service**
 - **BIG Discounts**
 - **Gift Certificates**

**Enroll now and get
100 FREE
Bonus Points!**

Simply call
1-800-697-1119 or
(954) 924-4418 (Outside the U.S.)
or apply online

INDEX

A					
Adaptors.....	51, 70, 74				
Adson Forceps.....	21				
Alligator Biopsy Forceps.....	79				
Allis Forceps.....	12, 19, 86, 87				
Anderson Clamps.....	5				
Anderson Forceps.....	19				
Atraumatic Tenaculum.....	44				
Auvard Speculum.....	8				
Axial Handle Needle Holder.....	89				
B					
Babcock Forceps.....	19, 86				
Baby Harrington Retractor.....	30				
Baby Tischler.....	40				
Baden Vaginal Defect Analyzers.....	10				
Balfour Four-Armed Retractor.....	24				
Balfour Retractors.....	24, 30, 32				
Bariatric Multi-Trac Retractor Set.....	32				
Bariatric Tray and Forceps.....	18, 19				
Biomedical Image Capturing Software.....	60				
Biopsy Forceps.....	79, 81				
Biopsy Punches.....	40, 41, 92				
Bipolar Cable.....	40, 41, 92				
Bipolar Instruments.....	91				
Braun Tenaculum.....	44				
Breisky Navratil Retractor.....	14, 20				
Breisky Retractors.....	9, 11, 14				
Burke Style Biopsy Punch.....	40				
C					
Cable (fiberoptic).....	62				
Cable (high frequency, monopolar & bipolar).....	92				
Camera & Coupler for Hysteroscopy.....	62				
Canal Finder (disposable).....	35				
Cannulas.....	21, 75, 76				
Cannula Sheaths.....	73				
Caps.....	72				
Carroll Prostatic Retractor.....	31				
Catheters.....	10, 23				
Cervical Hooks.....	42				
Cervical Forceps.....	44, 45				
Cervical Tenacula & Forceps.....	44				
Cervical & Uterine Instruments.....	21, 22				
Cholangiography Forceps for Catheters.....	88				
Clamps.....	3-5, 12, 19				
Clark Artery Forceps.....	19				
Clark Clamp.....	5				
Claw Grasping Forceps.....	80				
Clearview.....	23				
Clinton-Graves Specula.....	36, 37, 47				
Clinton-Pederson Specula.....	36, 37, 47				
Clinton XLong Vaginal Specula.....	36				
Clip Application Forceps.....	88				
Closed Shanks Retractors.....	37				
Cohen Marina Cannula / Manipulator.....	21				
Collin Grasping Forceps.....	86				
Collin Specula with Smoke Tube.....	47				
Colposcopes.....	57-60				
Colposcope Accessories.....	60				
Colposcopy Instruments.....	41				
Containers / Matching Trays.....	70, 93-95				
Continuous Flow Operating Sheaths.....	66				
Corrugated Tubing Assembly.....	52				
Curettes.....	44				
Cushing Vein Retractor.....	19				
D					
Deaver Retractor Blades.....	30				
DeBakey Forceps.....	18, 83, 85, 87				
Deep Pelvic Instruments.....	18, 19				
Deep Pelvic Retractors.....	24, 25, 31				
Deep Pelvic Tray.....	18, 19				
Desjardin Forceps.....	45				
Detachable/Rotable Grasping Forceps.....	79-87				
Diagnostic Colposcope.....	59				
Diagnostic Instruments for Pelvic Disorders.....	10				
Diagnostic & Operative Endo Accessories.....	74, 92				
Diagnostic Sheaths.....	63, 66				
Dilators & Dilator Set.....	38, 39, 44, 75				
Disposable Canal Finder.....	34, 35				
Disposable Specula.....	38				
Dissecting Forceps.....	80				
Dolphin-Nose Forceps.....	81				
Double Hook Malleable Retractor.....	31, 32				
DSE Tubing.....	52				
Dual Grasping Forceps.....	86				
E					
Electrodes.....	46, 48, 49, 69, 90, 91				
Electrode Chart.....	49				
Electrode Surgical Instruments.....	46, 48, 51, 69				
Electrode Sterilization Tray.....	46, 48				
Electrodes with Handles.....	90				
Emmett Hook.....	42, 48				
Endo Clinch Forceps.....	84				
Endocervical Curettes.....	41				
Endocervical Specula.....	41				
Endometrial Curettes.....	44				
Endometrial Samplers.....	34				
Endoscopes.....	65				
Endoscopic Instruments (Handles).....	77				
Endoscopy Accessories.....	70, 72, 74, 92				
Eppendorfer Biopsy Punch.....	40				
Extra Long Vaginal Specula.....	36				
Eye Guards (rubber).....	60				
F					
Fallopian Tubal Forceps.....	43				
Fan Retractors.....	90				
Fascialata Stripper.....	10				
Fiberoptic Cable.....	62				
Fiberoptic Pelvic Assistant.....	15-17				
Filters/Pre-filters for Smoke Evacuators.....	52				
Flexible Instruments (Endo).....	64				
Foerster Sponge Forceps.....	44				
Foot / Hand Control Pencils.....	51				
Forceps.....	6, 10, 12, 18, 19, 21, 42, 43, 45, 48				
Additional Forceps.....	63, 80-87				
Four-Armed Balfour Retractor.....	24				
Four-Bladed Vaginal Speculum.....	35				
Four-Sided Wall Retractors (non-conductive).....	47				
Fundus Grasping Forceps.....	82, 84				
G					
Gall Bladder Retractor.....	31				
Gelipi Retractors.....	31, 32				
Gemini / Mixer Forceps.....	18				
General Surgery & Deep Pelvic Retractors.....	31				
Glassman Grasping Forceps.....	83				
Glenn-Hysterectomy Clamps.....	5				
Goulet-Simpson Retractors.....	33				
Graduated Handles.....	21				
Grasping Forceps.....	42, 63, 80-87				
Graves Specula.....	36, 47				
Guttman Specula & Retractors.....	25				
H					
Hand & Foot Control Pencils.....	46, 51				
Handles for Endoscopic Instruments.....	77				
Hank Dilators.....	39				
Hardy-Duddy Speculum.....	8				
Harrington Retractors.....	30, 32				
Hasson Grasper.....	71				
Hasson S-Shaped Retractors.....	71				
Harrington Retractor Blades.....	26, 30, 32				
Headlight System (portable).....	61				
Heaney Curette.....	41				
Heaney-Ballentine Hysterectomy Clamp.....	4				
Heaney Hysterectomy Clamps.....	4				
Heaney Needle Holder.....	6, 19				
Heaney-Simon Lighted Retractor.....	11				
Hegar Dilators.....	39				
Hemorrhage Occluder Pin.....	12				
HGS-SONO Catheter.....	23				
Hooks.....	12, 42, 45, 48				
Hook Scissors.....	78				
Hysterectomy Clamps.....	2-5				
Hysterectomy Special Accessories.....	8				
Hysteroscopy Systems / Hysteroscopes.....	62-65				
I					
IFP Clamp.....	3				
Instrument Identification.....	95				
IUD Extractors, Hooks & Polyp Forceps.....	45				
Image Capturing Software.....	60				
Infundibular Pelvic Clamp.....	3				
Inner Sheaths.....	66, 68				
Insufflation Needle.....	75				
Internal Indicator Strips.....	31				
Irrigation & Suction Cannulas.....	75, 76				
Iris Hook.....	42, 46, 48				
J					
Javerts Forceps.....	45				
Johan Forceps.....	80				
Jordan-Richardson-Simpson Retractors.....	29				
Jordan-Simpson Retractors.....	27, 33				
K					
Kelly Grasping Forceps.....	81				
Kelly Retractors.....	29, 32				
Kevorkian Biopsy Punches.....	40				
Kevorkian Curettes.....	41				
Kirschner Retractor Blades & Frames / Set.....	24				
Kocher Forceps.....	18, 80, 81, 83				
Kogan Endocervical Specula.....	41, 47				
Kovac Hysterectomy Clamp.....	3				
Knot Pushers.....	90				
Knot Tier Forceps.....	84				
Krobach Tissue Clamp.....	12, 71				
L					
Lahey Forceps.....	6				
Laparoscopy Accessories.....	92				
Laparoscopy Instruments.....	73				
Lateral Wall Retractors.....	37, 47				
Ligature Carriers & Set.....	20				
Lighted Retractors.....	11				
Light Source.....	62				
Liver Retractors.....	30				
Lletz System.....	46				
Lletz Accessories.....	50-52				
Loop, Ball & Needle Electrode.....	46, 48				
Loughlin-Simpson Retractor.....	29				
M					
Malleable Retractor Blades.....	29, 31, 32				
Manipulators.....	21-23				
Marina Liver Retractors.....	30				
Marina Masson Fascialata Stripper.....	10				
Marina Multiple Retractor (Multi-trac).....	26-33				
Marina "Triple Threat" Suction Tube.....	11				
Marina Weisman Specula (Open-Sided).....	37				
Martin Myomectomy Scissors.....	13				
Martin's Arm.....	14				
Maryland DeBakey Grasping Forceps.....	85				
MAOI Pack & Syringe.....	34				
Masson Fascialata Stripper.....	10				
Masson Needle Holder.....	19				
Masterson Hysterectomy Clamp.....	4				
Mayo-Hegar Needle Holders.....	21				
Mayo-Noble Vaginal Dissection Scissors.....	6				
Metzenbaum Dissection Scissors.....	6				
Metzenbaum Scissors.....	6, 18, 78				
McCall Uterosacral Pedicle Clamp.....	12				
M.D. Anderson Clamp.....	5, 19				
Micro Dissection Needles.....	43				
Microsurgery Scissors.....	43				
Microsurgery Instruments.....	43				
Mini Cervical Dilator Set.....	39				
Mini Grasping Forceps.....	82				
Mini Mayo Tray for Martin's Arm.....	14				
Mini Smoke Evac. ULPA Charcoal Filters.....	52				
Microsurgery Instruments.....	43				
Minor Surgery Sets.....	21				
Mixer Grasping Forceps.....	18, 85, 86				
Miyazaki All-Purpose Retractor.....	11				
Miyazaki Ligature Carrier & Set.....	20				
Miyazaki Lighted Retractors.....	11				
Miyazaki Notched Speculum.....	20				
Miyazaki Sacroproxy Retractor.....	11				
Miyazaki Tack Driver Set.....	12				
Modular Suction/Irrigation Systems.....	76				
Monitors.....	62				
Monopolar High Frequency Cable.....	92				
Moore-Graves Speculum.....	36				
MP-IFP Clamp.....	3				
MP Parametrium Hysterectomy Clamps.....	2, 3, 19				
MP Parametrium Scissors.....	6, 19				
Multiple Grasping Forceps.....	82				
Multiple Retractors.....	26-33				
Myoma Drills.....	71				
Myoma Grasping Forceps.....	41				
Myomectomy Scissors.....	13				
Myotome Instrument Set.....	13				
N					
Needle Extensions.....	42, 48				
Needle Holders.....	5, 6, 19, 21, 89				
Needle Nose Grasping Forceps.....	80				
Nichols Weighted Speculum.....	8				
Nolan Needle Holder.....	5, 19				
Non-Conductive Instruments.....	43, 46-48				

PRESORTED
STANDARD
U.S. POSTAGE
PAID
FT. LAUD., FL
PERMIT NO. 5158



955 Shotgun Road

Sunrise, FL 33326 USA

Tel: (954) 924-4418

Toll-Free: (800) 697-1119

Fax: (954) 924-4419

Toll-Free Fax: (800) 748-2089

www.marinamedical.com