

Aesthetic Surgery

Product Catalog



M&M MEDICAL



*Marina and Anthony Zinnanti, Jr.
Founders*

A Message to Our Customers



As the growth of Marina Medical continues at a very exciting rate, we want to thank each of our customers for your continued loyalty and confidence in our product line. We have a deep gratitude to more than 5,000 offices in Plastic Surgery, Dermatology, and related disciplines who have become customers in the last five years.

Since we attended our first clinical meeting in 1999 with the marketing philosophy of "The Doctor's Wholesaler", and offering excellent instruments at excellent prices, you have responded with your support and confidence in this program.

Now, we would like to do a little more for our loyal customers. Therefore, we are introducing the Marina Medical Preferred Customer Program. Through this program you are able to get additional rewards for the business that you continue to send to Marina Medical. The Preferred Customer Program is explained on page 2. Please take the time to acquaint yourself with it since you truly deserve our support as we have received yours.

Sincerely,

Marina C. Zinnanti

Anthony Zinnanti, Jr.

Marina C. Zinnanti

Anthony Zinnanti, Jr.

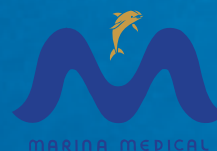

TABLE OF CONTENTS



Endoscopic 4-8

| | |
|--|-----|
| <i>Instruments for Forehead and Facelift Endoscopy</i> | 4 |
| Telescope for Plastic Endoscopy | 4 |
| Endoscopic Sheaths | 4 |
| Suction Coagulator..... | 4 |
| <i>Instruments for Endoscopic Endobrow</i> | 5 |
| Endoplastic Graspers & Scissors | 5 |
| <i>Endo Dissectors</i> | 6-7 |
| <i>Endoscopic Retractors</i> | 8-9 |
| <i>Endoscopic Equipment</i> | 10 |

Scissors 11-23

| | |
|------------------------------------|-------|
| <i>General Series</i> | 12 |
| Operating Scissors | 12 |
| <i>Standard Iris Series</i> | 13 |
| <i>Dissecting Series</i> | 14-15 |
| <i>Specialty Series</i> | 16-17 |
| <i>Tenotomy Series</i> | 18 |
| <i>Stitch Removal Series</i> | 19 |
| <i>Nasal Series</i> | 20-21 |
| <i>Rhytidectomy Series</i> | 22-23 |
| <i>Micro Series</i> | 24 |

Forceps & Clamps 25-34

| | |
|--|-------|
| <i>Dressing & Tissue Forceps</i> | 26-27 |
| <i>Bi-Polar Forceps</i> | 28 |
| <i>Jeweler Series</i> | 28 |
| <i>Specialty Forceps</i> | 29 |
| <i>Micro Forceps</i> | 29 |
| <i>Splinter & Suture Removal Forceps</i> | 30 |
| <i>Specialty Forceps</i> | 31 |
| <i>Hemostatic Clamps</i> | 32 |
| <i>Hemostatic Forceps</i> | 33 |
| <i>Towel Clips</i> | 33-34 |

Needle Holders 35-38

| | |
|-----------------------------------|----|
| <i>Needle Holders</i> | 36 |
| <i>Micro Needle Holders</i> | 38 |

Retractors & Skin Hooks 39-48

| | |
|---|-------|
| <i>Breast Retractors & Dissectors</i> | 40-41 |
| <i>Retractors</i> | 42-43 |
| <i>Special Retractors</i> | 44 |
| <i>Tissue Wound Retractors</i> | 45 |
| Self-Retaining Skin Retractors | 45 |
| <i>Skin Hook Retractors</i> | 46-47 |
| <i>Rake Retractors</i> | 48 |

Ear, Nose & Throat 49-62

| | |
|---|-------|
| <i>Nasal Series Specialty Retractors</i> | 50 |
| <i>Periosteal Elevators</i> | 51 |
| <i>Ear Loops</i> | 52 |
| <i>Curettes</i> | 52 |
| <i>Mirrors & Accessories</i> | 53 |
| <i>Nasal Rasps</i> | 54-55 |
| <i>Chisels/Osteotomes</i> | 56-57 |
| <i>Mallets</i> | 58 |
| <i>Cartilage Crushers</i> | 59 |
| <i>Rubin Rhinoplasty Set</i> | 59-60 |
| <i>Rongeurs & Bone Cutters</i> | 61 |
| <i>Truswell Trocar & Alligator/Cupped Forceps</i> | 62 |

Dermatology 63-68

| | |
|------------------------------|----|
| <i>Biopsy Punches</i> | 64 |
| <i>Bowls</i> | 64 |
| <i>Dermal Curettes</i> | 65 |
| <i>Extractors</i> | 66 |
| <i>Nail Nippers</i> | 67 |
| <i>Scalpel Handles</i> | 68 |
| <i>Scalpels</i> | 68 |
| <i>Scalpel Remover</i> | 68 |

Liposuction & Garments 69-74

| | |
|--|----|
| <i>Cannulas & Tubing</i> | 70 |
| <i>Aspirators, Infusion & Tubing</i> | 71 |
| <i>Garments for Liposuction</i> | 72 |
| <i>Binders</i> | 73 |
| <i>Compression Garments</i> | 73 |
| <i>Surgical Bras</i> | 74 |

Surgical Accessories 75

| | |
|---|-------|
| <i>Calipers</i> | 76 |
| <i>Markers</i> | 77 |
| <i>Laser Eyewear</i> | 78-79 |
| <i>Ocuplasty</i> | 79 |
| <i>ESU</i> | 80 |
| Smoke Evacuation Systems..... | 80 |
| Reusable Electrodes - Cutaneous Surgery | 80 |
| Micro Dissection Needles | 80 |
| <i>ULPA Filters, Tubing & Accessories</i> | 81 |
| <i>Cryosurgery</i> | 82 |
| <i>Hair Restoration</i> | 83 |
| <i>Sterilization & Infection Control</i> | 84 |
| <i>Sterilization Containers</i> | 85 |
| <i>Fiberoptic Illumination Systems</i> | 86 |
| <i>Instrumentation Sets</i> | 87 |

Index 88-89

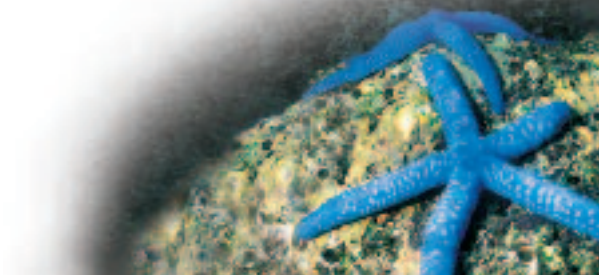

The Value of the Preferred Customer Program



Join the Marina Medical

PREFERRED CUSTOMER CLUB

And start earning valuable rewards

Ask Your Account Manager Now

What is the Preferred Customer Program?

This is the **Marina Medical** way of saying "Thank You" to our customers. **Marina Medical** believes in sharing in its success and growth. Who better to share with than the customers that have helped us achieve our success. You do not have to do anything differently than what you are currently doing. By being a customer of **Marina Medical**, your account is automatically entered into the **Preferred Customer Program**. Obviously, the more you use **Marina Medical** products, the more Preferred Customer Reward Points will accumulate into your account. There is no extra cost or fee to you. It is simply a Thank You from **Marina Medical**.

How do you keep account of your points?

There are at least three ways for you to keep track of your Point Total. **Marina Medical** will send to you a quarterly update of your Point Total, along with announcements about the program. Your Point Total will also be on-line at www.marinamedical.com on any day that you access the **Marina Medical** website. You may also call **Marina Medical** Customer Service on any business day and ask for your Point Total.

What can you do with your points?

You may cash in your Preferred Customer Points for Preferred Customers Rewards including free instruments, instrument repair, discounts on future orders, or free services. A Rewards Chart may be requested from your **Marina Medical** Sales Rep. Watch for new Preferred Customer Rewards to be added to the Preferred Customer Program with each quarterly newsletter.

Warranty

Marina Medical stainless steel instruments are warranted for a period of two (2) years from the original date of purchase. **Marina Medical** single patient use products are warranted for 90 days against defects in workmanship or materials that are discovered prior to initial use or expiration. If **Marina Medical** instruments should fail as the result of a defect in materials or workmanship, **Marina Medical** is committed to take steps it believes are necessary to rectify the problem. These steps may include, but are not limited to, repair, replacement or supplying an alternative instrument. This warranty does not cover general maintenance such as cleaning and sharpening services required as a result of normal use. It does not include damage that is caused by misuse, improper care, the use of improper chemicals or cleaning methods, negligence, modification or unauthorized service by non-**Marina Medical** personnel, or normal wear. Damage to insulating coatings on electrosurgical instruments is excluded from the terms of this warranty.

The sole remedy under this warranty shall be repair or replacement as provided above at the sole discretion of **Marina Medical** Instruments. In no event will **Marina Medical** be liable for any damages arising out of loss of use, or any other incidental or consequential damages. The foregoing limited warranty is in lieu of any other warranty with respect to **Marina Medical** products. **Marina Medical** grants no other warranty, express or implied.



Returned Goods Policy

- Goods will be accepted for return for the following reasons and must be accompanied by a RGA.:
 - If shipment was made without Customer's authorization;
 - If incorrect items were shipped;
 - If defective items were shipped;
 - If defective goods are covered by the standard warranty;
 - If the goods were sent on evaluation basis.
- To return goods, contact a Customer Service Representative by telephone for an RGA (Returned Goods Authorization) number. The RGA # must also be clearly indicated on the outside of the returned package. Please have the following information:
 - Reason you wish to return the goods;
 - Quantity, description, product number;
 - Date of Receipt of Order;
 - Customer's Purchase Order and the Marina Medical invoice number;
 - All instruments that have been used must be cleaned and sterilized prior to shipment.
- Shipment must be returned prepaid by Customer. Freight collect shipments will not be accepted.
- If Customer intends to return equipment ordered in error, the following restocking charges and terms will apply:
 - 25% within 90 days from date of shipment;
 - Goods must be returned unused, in the original carton, and in marketable condition;
 - Refurbishing and replacement charges will be added to the restocking charges for damaged or missing items;
 - No return after 90 days;
 - No refund on sterile, single-use disposable products.
 - No refund will be made on customized instruments.

Send all Returns to:

Marina Medical
955 Shotgun Road
Sunrise, Florida 33326 USA



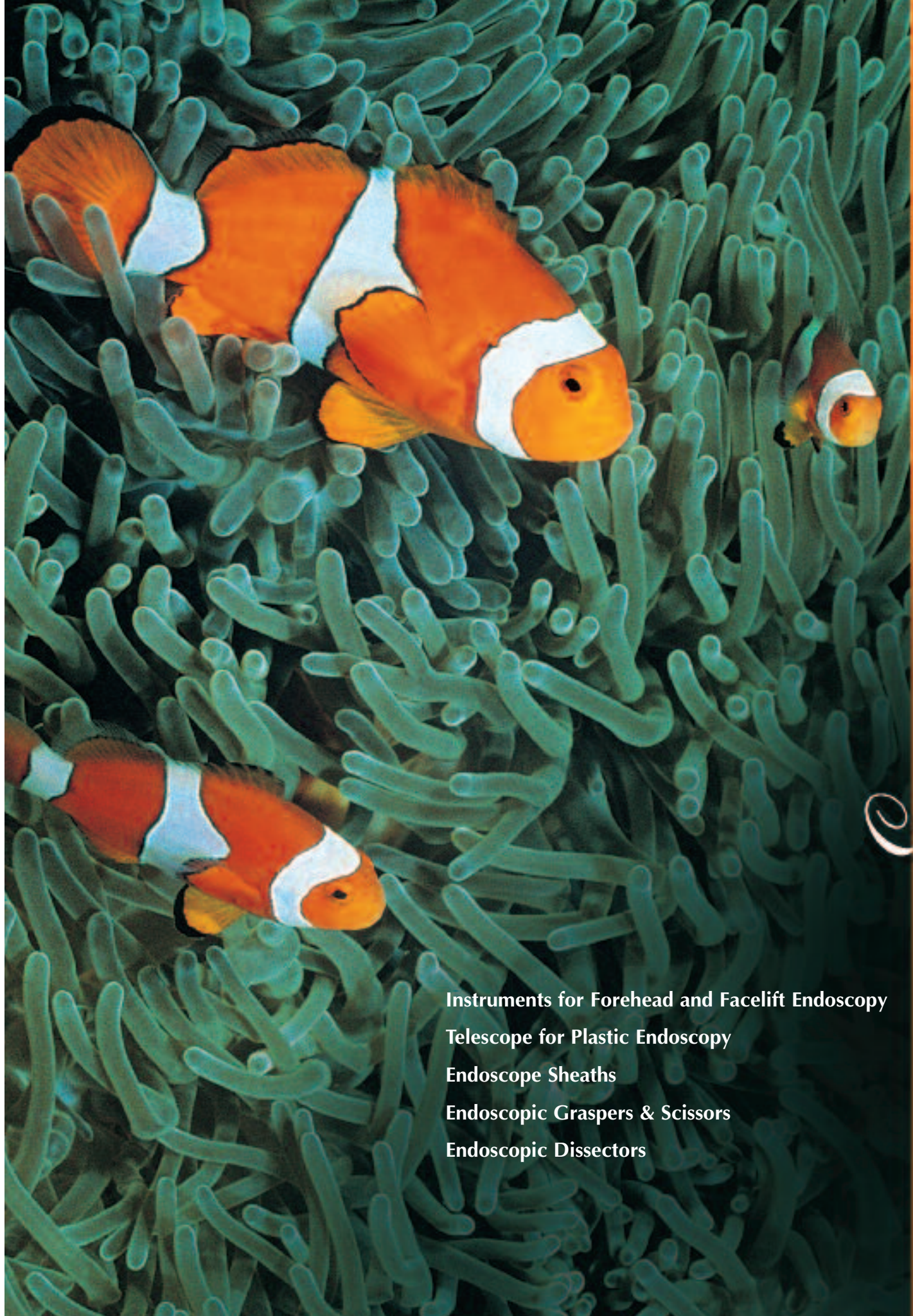

ENDO SCOPIC

- Instruments for Forehead and Facelift Endoscopy
- Telescope for Plastic Endoscopy
- Endoscope Sheaths
- Endoscopic Graspers & Scissors
- Endoscopic Dissectors



ENDOSCOPIC - *Instruments for Forehead and Facelift Endoscopy*

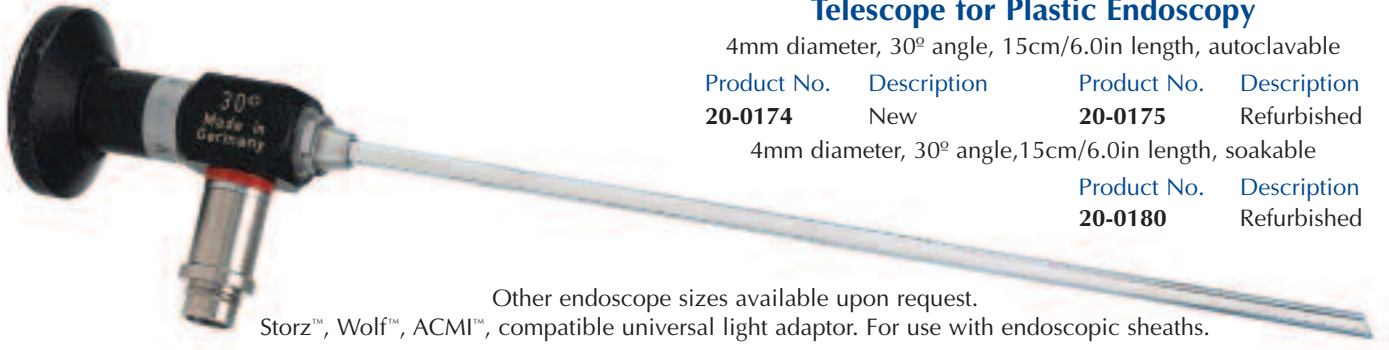

Telescope for Plastic Endoscopy

4mm diameter, 30° angle, 15cm/6.0in length, autoclavable

| Product No. | Description | Product No. | Description |
|--|-------------|-------------|-------------|
| 20-0174 | New | 20-0175 | Refurbished |
| 4mm diameter, 30° angle, 15cm/6.0in length, soakable | | | |
| Product No. | Description | | |
| 20-0180 | Refurbished | | |

Other endoscope sizes available upon request.
Storz™, Wolf™, ACMI™, compatible universal light adaptor. For use with endoscopic sheaths.

Endoscopic Sheaths



Sheath with one rotating stop cock, spatula tip for the best view during tissue dissection.

Product No.
08-0170

Storz™ compatible



Sheath for plastic endoscopy with one rotating stop cock, with a flat spatula tip.

Product No.
08-0165

Storz™ compatible



Suction Coagulator

| Product No. | Description |
|-------------|---|
| 08-0180 | Spatula electrode, straight, with suction and stop cock |
| 08-0182 | Spatula electrode, curved, with suction and stop cock |
| 08-0184 | J-hook electrode, straight, with suction and stop cock |
| 08-0186 | J-hook electrode, curved, with suction and stop cock |

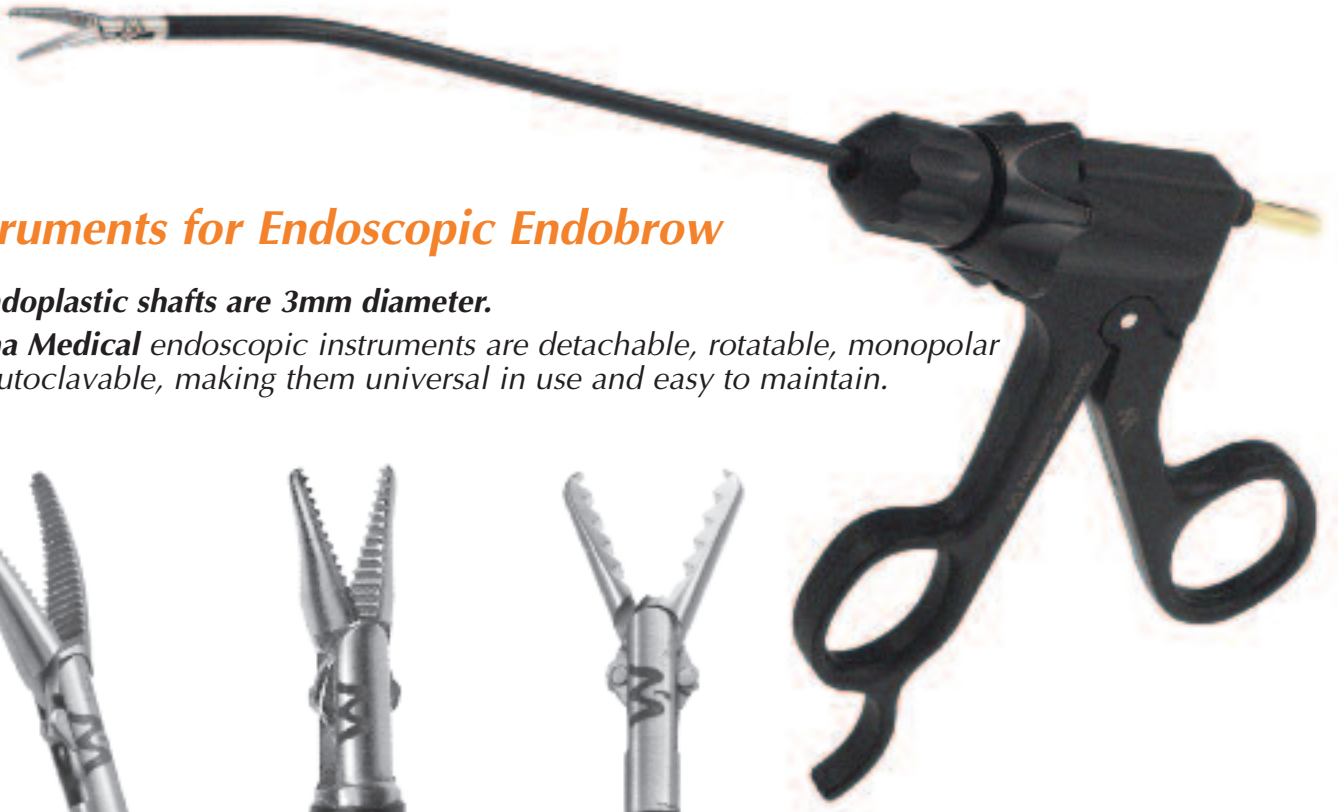

Instruments for Endoscopic Endobrow

All endoplastic shafts are 3mm diameter.

Marina Medical endoscopic instruments are detachable, rotatable, monopolar and autoclavable, making them universal in use and easy to maintain.



Curved Grasper
150-590



Needle Nose Grasper
150-586



Heavy Grasper
150-588



**Micro Hook
Scissors**
150-552



Micro Metzenbaum Scissors
Product No.
150-548
150-550



Description
Straight
Curved



**Custom
Instruments
available!**



ENDOSCOPIC

Marina Endo Dissectors

Designed to fit facial contours in endobrow and oculo-plastic procedures. A wide variety of styles available to accommodate different surgical procedures. Excellent balance, excellent grip.



Ergo Handle



For early dissection

Product No.
150-328
Slightly curved shaft, Langenbeck chisel tip, 7.0mm wide Length: 24.0cm/9.5in

150-327 - 5.0mm Tip
150-329 - 10.0mm Tip



For early dissection

Product No.
150-338
Straight shaft, slightly curved Langenbeck chisel tip, 7.0mm wide. Length: 22.5cm/8.75in

150-337 - 5.0mm Tip
150-339 - 10.0mm Tip



For broad quick scalp dissection

Product No.
150-322
Slightly curved shaft, tapered chisel tip, 30°, 12.5mm wide. Length: 24.0cm/9.5in



Curved with tapered tip for controlled dissection

Product No.
150-342
Curved shaft, cottle tip, 7.0mm wide. Length: 24.0cm/9.5in



Straight with tapered tip for controlled dissection

Product No.
150-341
Straight shaft, cottle tip, 7.0mm wide. Length: 24.0cm/9.5in



Periosteal dissector

Product No.
150-325
Curved shaft, wide, concave, shovel tip. Length: 25.0cm/10.0in



Small chisel head for orbital rim dissection

Product No.
150-323
Half curved shaft, mini-Langenbeck tip. Length: 24.0cm/9.5in

Product No.

150-340

Slightly curved shaft, tapered angled chisel tip,
12.5mm wide. Length: 23.0cm/9.0in

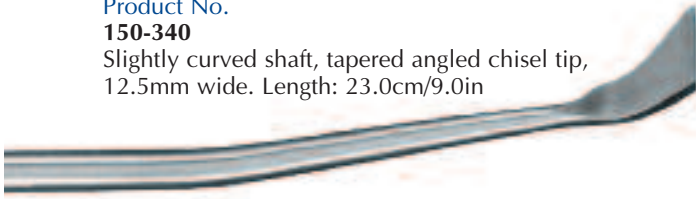

Scalp dissector

For Malleable instruments, add **M
to the product number.**

Product No.

150-332

S-shaped shaft, tapered and rounded tip,
10.0mm wide. Length: 24.0cm/9.5in



Mid face fascia dissector

Product No.

150-350

Endo Nerve Hook, curved, left.
Length: 24.0cm/9.5in

150-352

Curved right

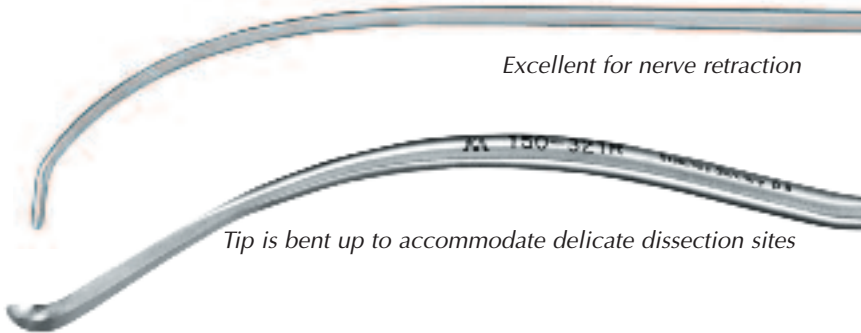

Excellent for nerve retraction

Tip is bent up to accommodate delicate dissection sites

Product No.

150-321

S-shaped shaft, round button finishing tip.
Length: 24.0cm/9.5in



Extends shaft for distant reach into periorbital areas

Product No.

150-324

S-shaped shaft, Langenbeck chisel tip, 7.0mm wide.
Length: 27.0cm/10.5in



Small cobra shaped head for nerve dissection

Product No.

150-336

Slightly curved shaft, mini-Cottle finishing tip,
4.0mm wide.
Length: 24.0cm/9.5in

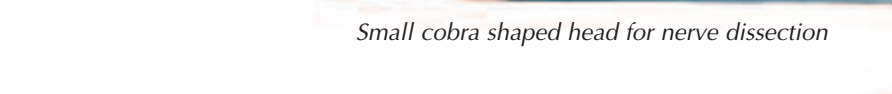

Product No.

150-326

Straight shaft, concave shovel tip.
Length: 24.0cm/9.5in



Temporal dissector

Product No.

150-344

Elevator with suction, round edges, slightly curved,
8.0mm wide
Length: 22.0cm/8.75in

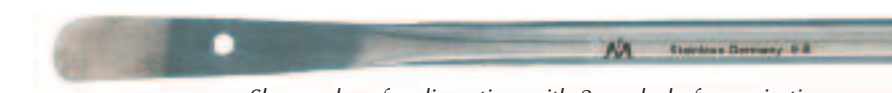

Sharp edges for dissection with 2mm hole for aspiration

ENDOSCOPIC - Marina Endoscopic Retractors

To add Fiberoptic Light, add **L** to the product number.
 To add Suction, add **S** to the product number.
 To add Fiberoptic Light and Suction, add **LS** to the product number.

To add Endoscopic Sheath, add **E** to the product number.
E requires 15cm length minimum blade and 15mm width minimum.

Each **Marina Medical Endo-Retractor** can be fitted with fiberoptic light and with suction. When intended for use with an endoscope, the Endo-Retractor will have the appropriate endoscope sheath mounted to it. **Marina Endo-Retractors** feature UNIVERSAL light cord adapters that are compatible to *Storz™, Wolf™, ACMI™, Olympus™* and most other fittings.



Tebbetts Style
(with tooth serrated end)

Product No.
110-685S

| Product No. | Blade Size (length x width) |
|----------------|-----------------------------|
| 110-690 | 80mm x 16mm |
| 110-685 | 100mm x 25mm |
| 110-686 | 120mm x 25mm |
| 110-687 | 120mm x 30mm |
| 110-688 | 150mm x 25mm |
| 110-689 | 150mm x 30mm |

Product shown is Tebbetts Style Retractor with Suction



Ferriera Style
(with smooth end)

Product No.
110-676L

| Product No. | Blade Size (length x width) |
|----------------|-----------------------------|
| 110-672 | 80mm x 16mm |
| 110-675 | 100mm x 25mm |
| 110-676 | 120mm x 25mm |
| 110-677 | 120mm x 30mm |
| 110-678 | 150mm x 25mm |
| 110-679 | 150mm x 30mm |

Product shown is Ferriera Style Retractor with Fiberoptic Light

Each Marina Medical Endo-Retractor blade can be customized to suit your personal preferences.

See pages 40-43 for additional Lighted Retractors.



Ferriera Style
(with smooth end)

Product No.
110-675LS

Product shown is
Ferriera Retractor with
Fiberoptic Light
and Suction

Fiberoptic Headlights

See page 86 for details.



**Autoclavable Fiberoptic
Cord**

| Product No. | Length |
|----------------|-------------------|
| 350-372 | 3 meters (10 ft.) |

(ACMI™ Light Source End/
Storz™ Instrument End)

▶ ENDOSCOPIC - *Marina Endoscopic Equipment*

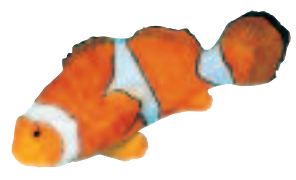

Flat Screen Monitor

L200-5152-0

This monitor is specifically designed with the operating room in mind. This guarantees unique advantages for the surgeon and the surgical team. Alternative TV monitor also available.
Alternative Brand Refurbished: **20-2035**

Capture Device

L201-4650-A

Easy digital video recording on CD-Rom. Up to 80 minutes perfect digital video recording on CD-Rom. VCD, DVD and PC compatibility. Easy operation including remote control. Free software package including video editing and still image extraction.

Camera (TC804)

L201-2561-0

Top performance endoscopic 3-CCD camera with extremely light-weight and ergonomic camerahead. Magnetic ring-focus for both right-and left-handed operation. Two camera head buttons for remote control. High resolution and excellent light sensitivity Adjustable triple field light level measurement. Easy "on the spot " cable replacement.

Alternative Brand Refurbished: **20-0200**

Light Source

L200-8282-0

XL300 top performance endoscopic 300 watt xenon lamp light source with microprocessor control and LCD display. Lamp-life LCD display and electronic lamp change indicator Multi-standard exchangeable light cable sockets. Easy lamp replacement.

Alternative Brand Refurbished: **20-2020**

Light Source - 150 watts

250-803

Hallogen, 110 volts
(not shown)

Light Cable

| Description | Product No. |
|----------------|----------------|
| ACMI to Storz™ | 350-372 |

ACMI light source end/Storz™ instrument end. Other connections available.

*Marina Medical provides a number of options to meet your needs for endoscopic equipment. Whether you choose new or refurbished equipment, you will receive technical support, warranted equipment and the quality you have come to trust from **Marina Medical**.*

Cart

5 shelf, two drawer, easy to clean cart with locking wheels

| Description | Product No. |
|-------------|----------------|
| Refurbished | 20-2021 |
| New | 20-2025 |







SCISSORS

- Operating Scissors
- Dissecting Scissors
- Iris Scissors
- Specialty Scissors
- Stitch Removal Scissors
- Tenotomy Scissors
- Nasal Scissors
- Micro Scissors
- Rhytidectomy Scissors

MARINA MEDICAL SCISSORS - General Series

German Stainless Steel

| | |
|---|---|
|  Stainless: | Highly corrosion-resistant German Stainless Steel is used in the manufacturing of each Marina scissors. |
|  Supercut: | One specially beveled blade gives the scissors additional guillotine cutting ability, while the other blade is serrated to hold the tissue. Excellent use when the tissue is denser. |
|  Tungsten Gold: | Special inserts of Tungsten Carbide line the edge of the blade. Tungsten Carbide is stronger than stainless steel and will keep a sharp cutting edge longer than regular stainless steel. |
|  Serrated: | For serrated blades. Add SR to any product number. |

Standard Operating Scissors

Excellent for cutting suture, tissue, and other general uses in the OR or office

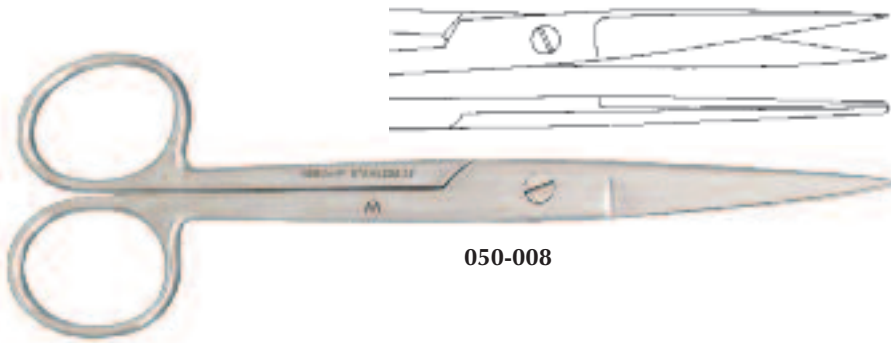

050-008

Sharp/Sharp

| Length | Straight | Curved |
|--------------|----------|---------|
| 11.5cm/4.5in | 050-002 | 050-032 |
| 12.5cm/5.0in | 050-004 | 050-034 |
| 15.0cm/6.0in | 050-006 | 050-036 |
| 16.5cm/6.5in | 050-008 | 050-038 |



 Add **SR**

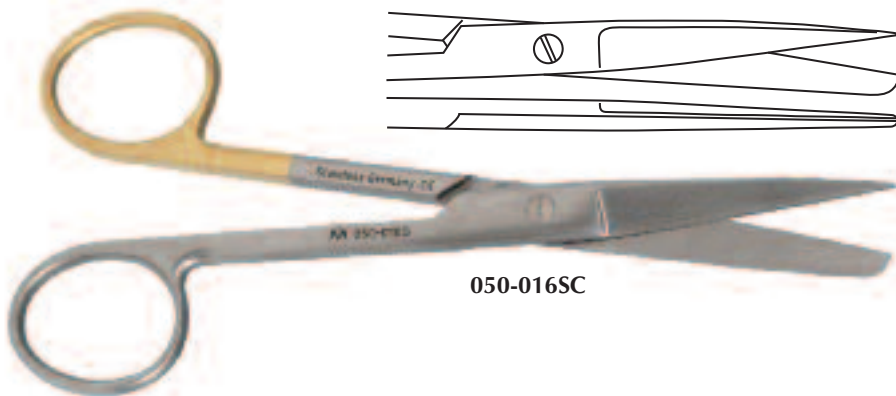

050-016SC

Sharp/Blunt

| Length | Straight | Curved |
|---------------|----------|---------|
| 11.5cm/4.5in | 050-012 | 050-042 |
| 12.5cm/5.0in | 050-014 | 050-044 |
| 14.5cm/5.75in | 050-016 | 050-046 |
| 16.5cm/6.5in | 050-018 | 050-048 |
| 18.5cm/7.25in | 050-019 | 050-050 |



14.5cm/5.75in 050-016SC



 Add **SR**

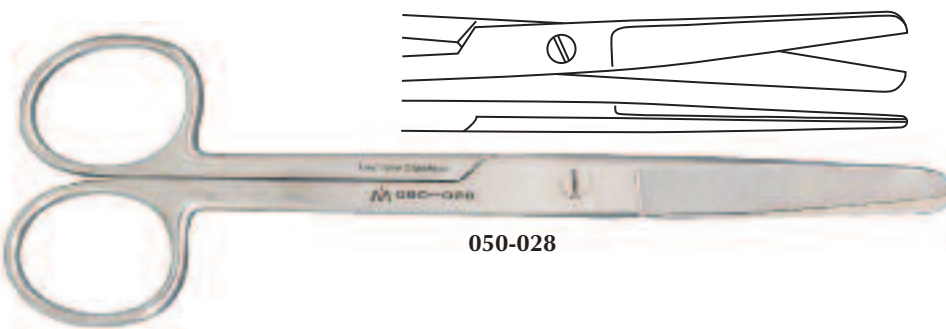

050-028

Blunt/Blunt

| Length | Straight | Curved |
|--------------|----------|---------|
| 12.5cm/5.0in | 050-024 | 050-052 |
| 15.0cm/6.0in | 050-026 | 050-056 |
| 16.5cm/6.5in | 050-028 | 050-058 |



 Add **SR**

Standard Iris Scissors Series

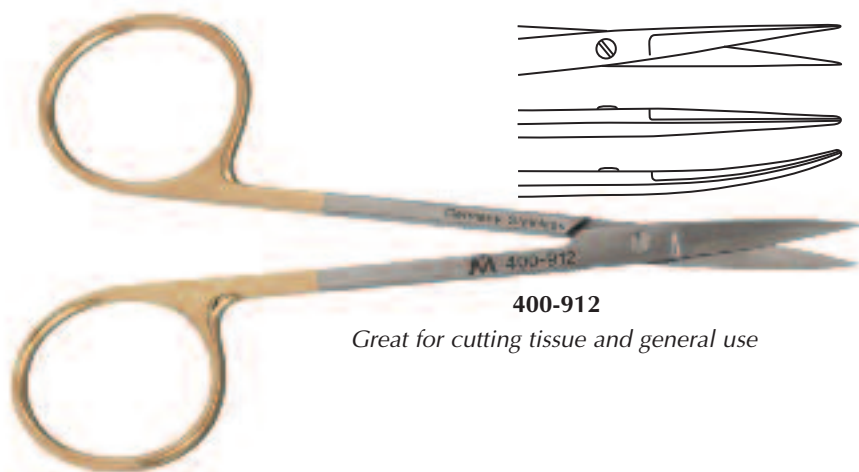

400-912

Great for cutting tissue and general use

Iris

| Length | Straight | Curved |
|-------------------------------------|--------------------------------------|--------------------------------------|
| 9.0cm/3.5in, Extra fine | 050-298 050-301 | 050-299 050-302 |
| 11.5cm/4.5in with serrated blade | 050-304 050-305 | 050-306 050-307 |
| 11.5cm/4.5in | 050-701SC | 050-702SC |
| 11.5cm/4.5in | 400-912 | 400-913 |

Add **SR**



Open Ring Iris

| Length | Straight | Curved | |
|--------------|--------------------|--------------------|-------------------|
| 11.5cm/4.5in | 050-309 | 050-310 | Add SR |

050-309

For those who prefer bigger finger rings



Scissors are considered to be the most important instrument used by a surgeon. **Marina Medical** believes that it carries the finest scissors available at unmatched prices. We believe so much in our scissors that we guarantee them for life against manufacturing defects when used for their intended purpose.



Side Angled

| Length | Straight |
|--------------|--------------------|
| 11.5cm/4.5in | 050-308 |

Side angle provides more leverage

Add **SR**

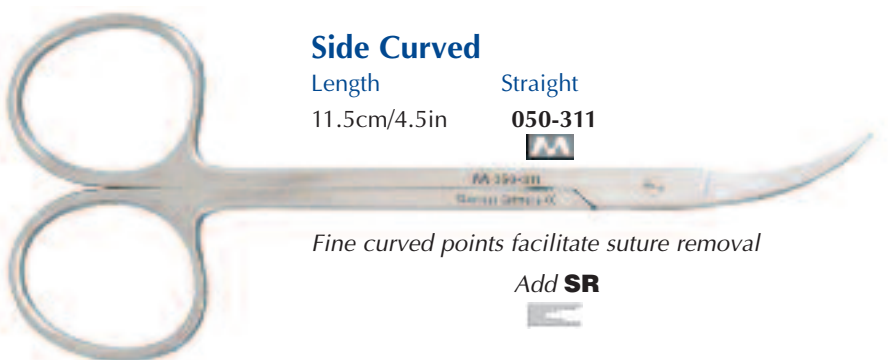

Side Curved

| Length | Straight |
|--------------|--------------------|
| 11.5cm/4.5in | 050-311 |

Fine curved points facilitate suture removal

Add **SR**

MARINA MEDICAL SCISSORS - *Dissecting Series*

German Stainless Steel



400-117

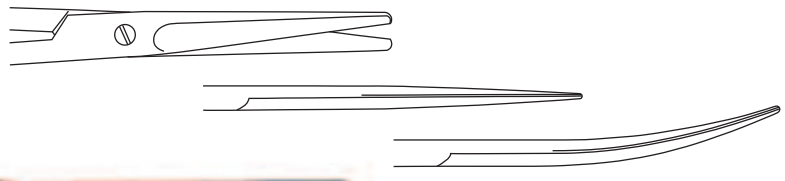

Mayo Scissors

Excellent scissors for dissection or general use

| Length | Straight | Curved | Straight | Curved | |
|---------------|----------------|----------------|----------------|----------------|---------------|
| 14.5cm/5.75in | 050-120 | 050-122 | 400-015 | 400-115 | |
| 17.0cm/6.75in | 050-124 | 050-126 | 400-017 | 400-117 | |
| 23.0cm/9.0in | 050-128 | 050-130 | 400-023 | 400-123 | Add SR |

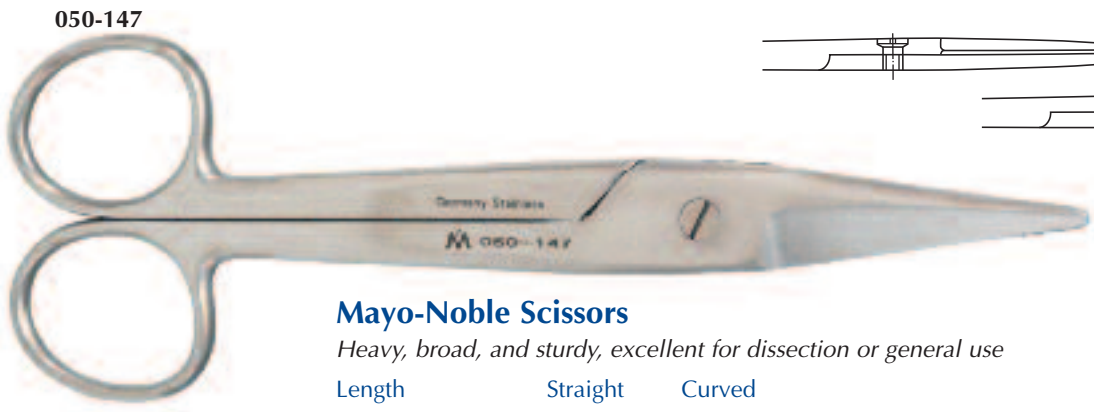

050-147

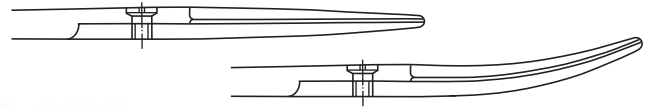

Mayo-Noble Scissors

Heavy, broad, and sturdy, excellent for dissection or general use

| Length | Straight | Curved | |
|---------------|----------------|----------------|---------------|
| 17.0cm/6.75in | 050-147 | 050-149 | |
| 19.5cm/7.75in | | 050-145 | Add SR |

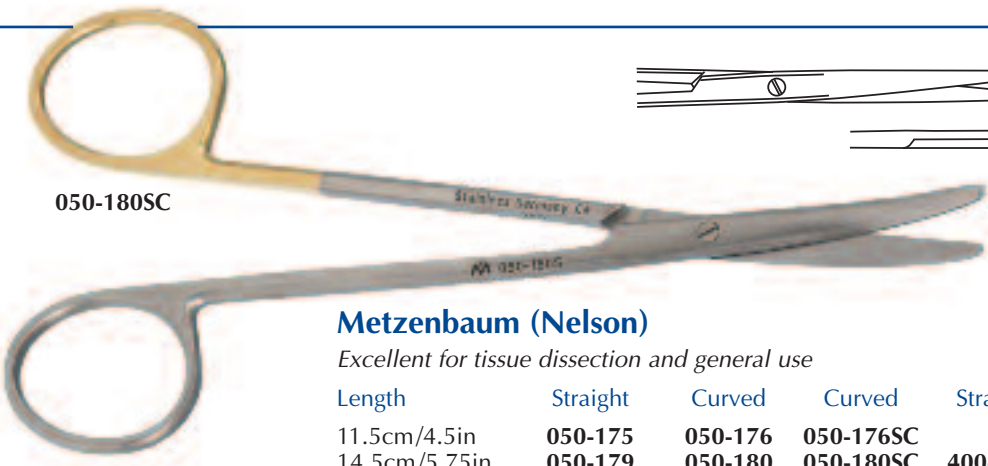

050-180SC

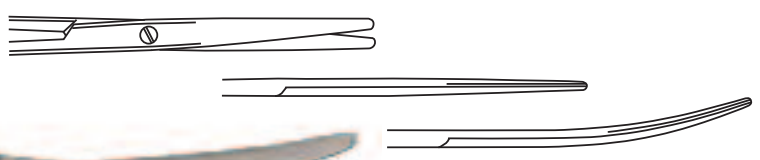

Metzenbaum (Nelson)





Excellent for tissue dissection and general use

| Length | Straight | Curved | Curved | Straight | Curved | |
|---------------|----------------|----------------|------------------|----------------|----------------|---------------|
| 11.5cm/4.5in | 050-175 | 050-176 | 050-176SC | | | |
| 14.5cm/5.75in | 050-179 | 050-180 | 050-180SC | 400-515 | 400-614 | |
| 18.0cm/7.0in | 050-181 | 050-182 | 050-182SC | 400-518 | 400-618 | |
| 20.0cm/8.0in | 050-183 | 050-184 | 050-184SC | 400-520 | 400-620 | |
| 23.0cm/9.0in | 050-186 | 050-188 | | 400-523 | 400-623 | |
| 28.0cm/11.0in | 050-190 | 050-192 | | 400-728 | 400-828 | Add SR |

Most **Marina Medical** scissors can be supplied in any variation of TC, SC, SS, and/or with serrations. The razor-sharp cutting edge of the Supercut scissors allow for smooth and effortless cutting through thick materials. The serrated cutting edge or the other cutting edge prevents the tissue from slipping. Supercut scissors are not suitable for wires, cartilage and other hard materials.



Categories







-  **Stainless**
-  **Supercut**
-  **Tungsten Gold**
-  **Serrated (add SR)**



400-923

Metzenbaum style scissors for cutting and tissue dissection

Strabismus



| | | |
|---|---|---|
| Length | Straight | Curved |
| 11.5cm/4.5in | 050-175 | 050-176 |
| |  |  |
| | | 050-176SC |
| | |  |
| 10.0cm/4.0in | 400-922 | 400-923 |
| |  |  |
|  Add SR | | |



050-316

Delicate shanks and short, rounded tips, very useful for undermining

Baby Lexer



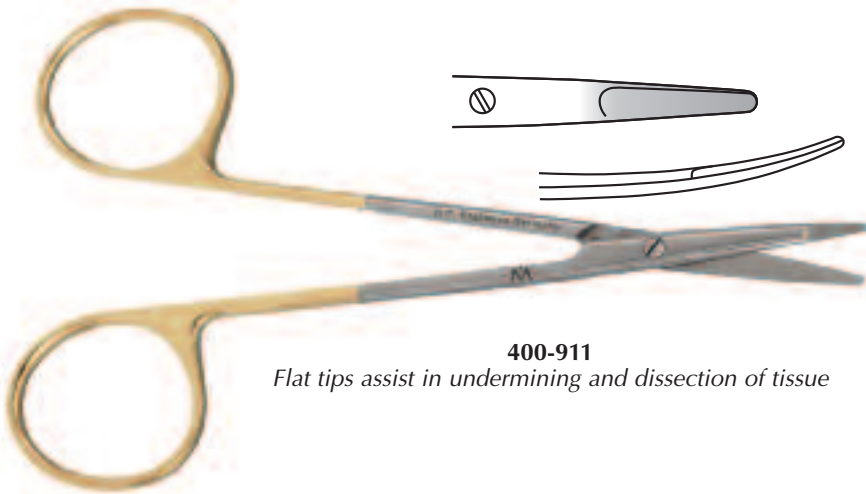

| | |
|---|---|
| Length | Curved |
| 10.0cm/4.0in | 050-316 |
| |  |
|  Add SR | |



400-911

Flat tips assist in undermining and dissection of tissue

Ragnell (Kilner)

| | | |
|---|---|---|
| Length | Straight | Curved |
| 12.0cm/4.75in | 050-425 | 050-426 |
| |  |  |
| Length | Straight | Curved |
| 12.0cm/4.75in | | 050-426SC |
| | |  |
| Length | Straight | Curved |
| 12.0cm/4.75in | 400-911 | 400-934 |
| |  | |
|  Add SR | | |



MARINA MEDICAL SCISSORS - Specialty Series

German Stainless Steel

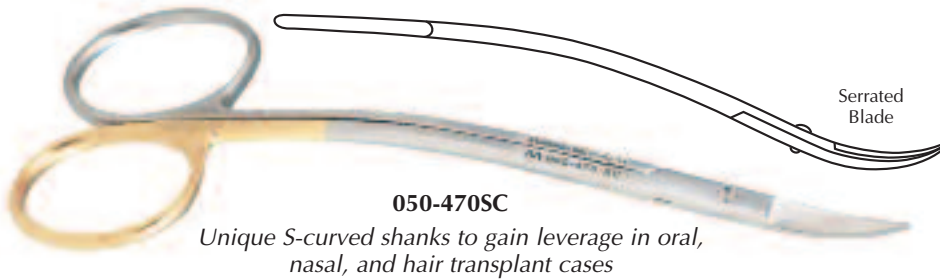

LaGrange S-Curved Shanks

Length
11.0cm/4.25in

Product No.
050-470



050-470SC

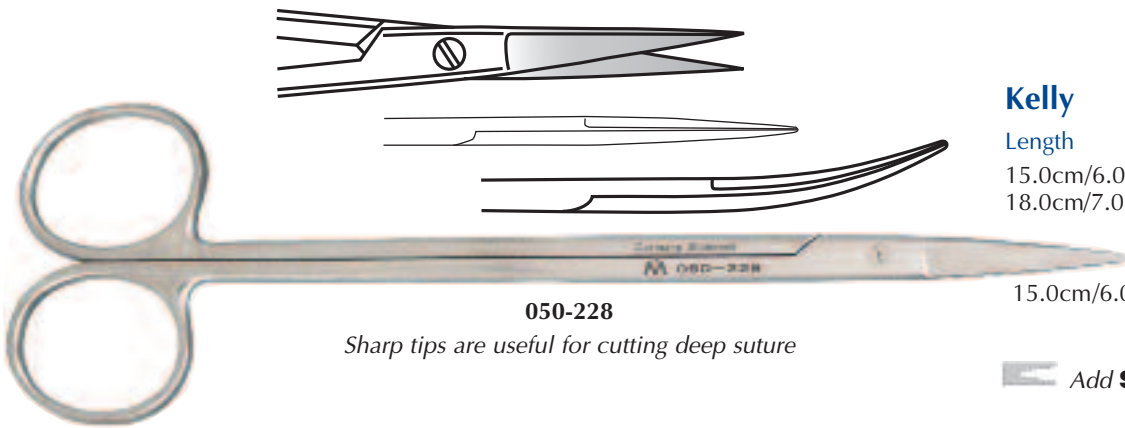

Kelly

Length
15.0cm/6.0in
18.0cm/7.0in

Straight
050-227
050-228

Curved
050-229
050-230



15.0cm/6.0in

400-940

400-941



Add **SR**

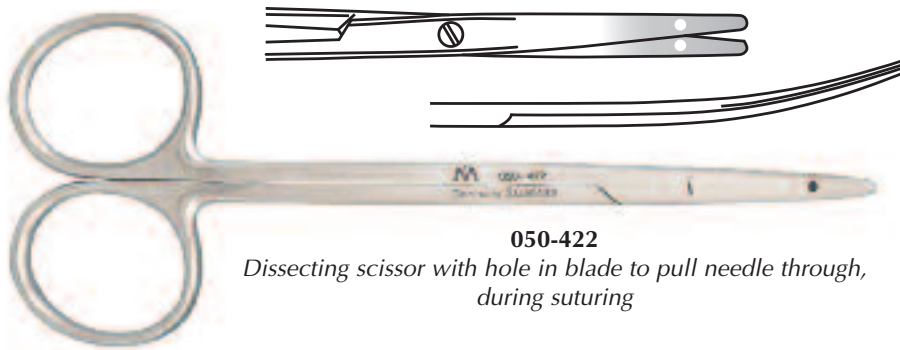

Littler

Length
11.5cm/4.5in, curved

Product No.
050-422



Add **SR**

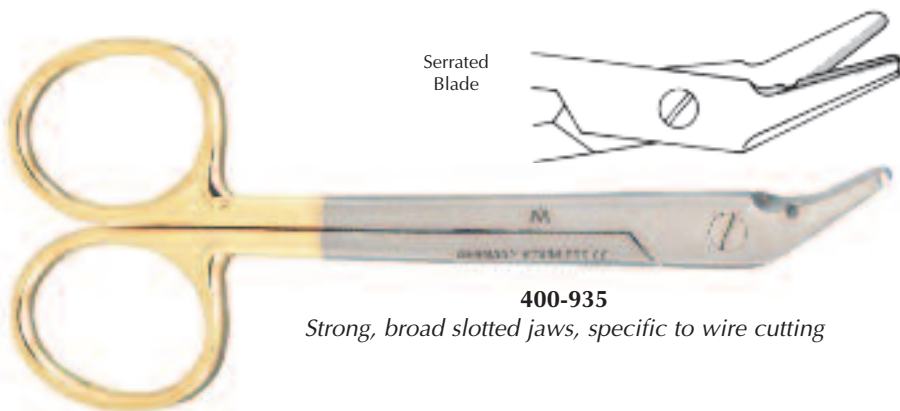

Wire Cutting

Length
12.0cm/4.75in

Product No.
050-260





400-935





Categories

-  **Stainless**
-  **Supercut**
-  **Tungsten Gold**
-  **Serrated (add SR)**

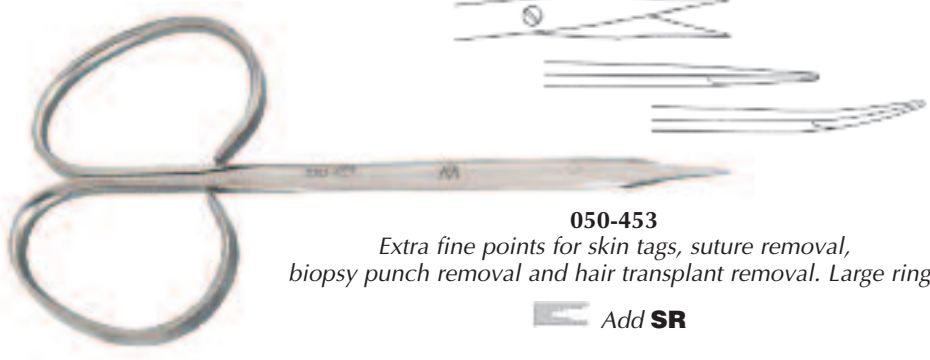

050-453
Extra fine points for skin tags, suture removal, biopsy punch removal and hair transplant removal. Large rings
 **Add SR**

Open Ring Gradle

| | | |
|--------------|---|---|
| Length | Straight | Curved |
| 10.0cm/4.0in | 050-453 | 050-455 |
| |  |  |

Closed Ring Gradle

| | | |
|--------------|---|---|
| Length | Straight | Curved |
| 10.0cm/4.0in | 050-453C | 050-455C |
| |  |  |

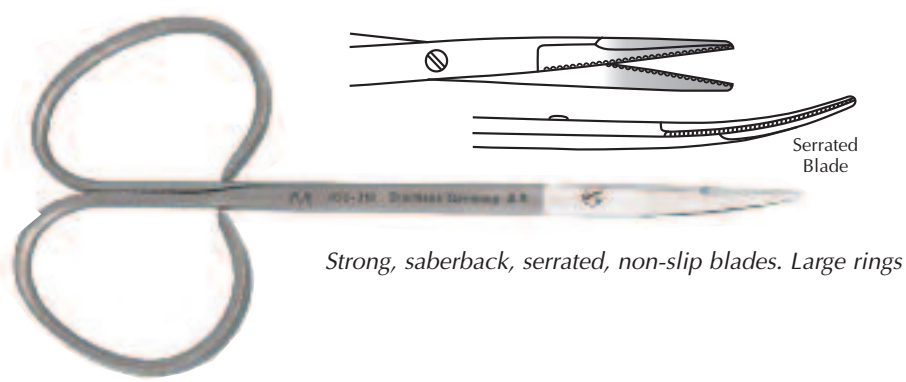

Strong, saberback, serrated, non-slip blades. Large rings
 Serrated Blade

Open Ring Kaye Blepharoplasty

| | |
|---------------|---|
| Length | Curved |
| 10.5cm/4.25in | 050-318 |
| |  |



Delicate, flat-tipped, serrated blade
 Serrated Blade

Marina Blepharoplasty

| | |
|---------------|---|
| Length | Curved |
| 13.5cm/5.25in | 400-927 |
| |  |



Great for cutting tough tissue, cartilage, and tissue dissection
 Serrated Blade

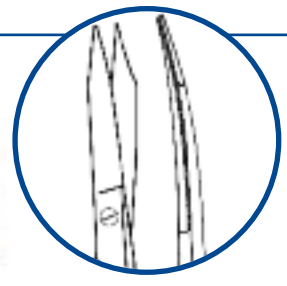

Martin Myomectomy

| | |
|---------------------|---|
| Description | Product No. |
| Straight, 20cm/8in. | 050-532 |
| Curved, 20cm/8in. | 050-534 |
| |  |

MARINA MEDICAL SCISSORS - Tenotomy Series

German Stainless Steel

Tungsten Carbide is one of the hardest alloys available and as a general rule, Tungsten Carbide instruments will last up to five times longer than stainless steel. **Marina Medical** offers Tungsten Carbide inlays that are soldered instead of welded, thus they are harder and will last longer than conventional Tungsten Carbide scissors.



Categories

-  **Stainless**
-  **Supercut**
-  **Tungsten Gold**
-  **Serrated (add SR)**

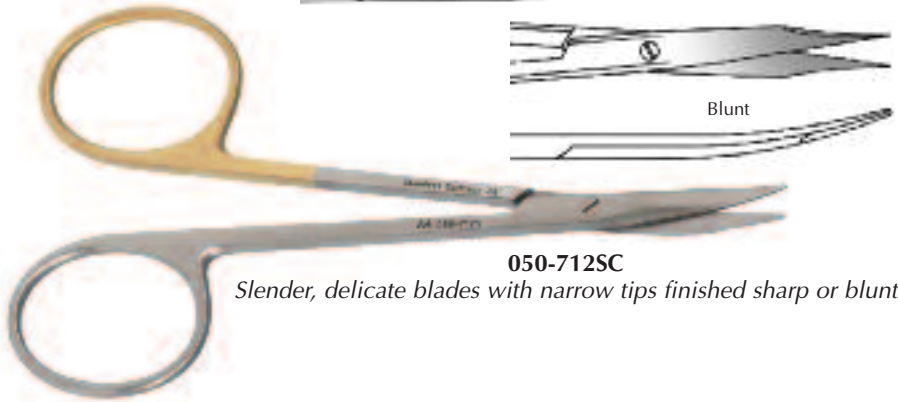
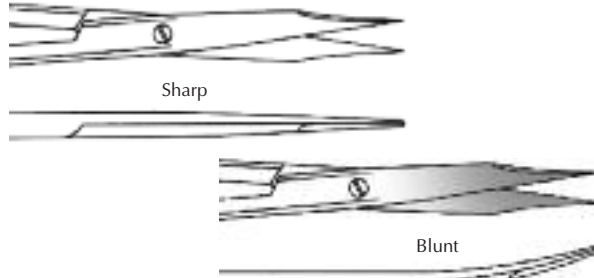

050-712SC

Slender, delicate blades with narrow tips finished sharp or blunt

Stevens Series

| Length | Description | Product No. |
|---------------|---------------|------------------|
| 12.5cm/5.0in | B/B, Curved | 050-402 |
| 11.0cm/4.25in | S/S, Curved | 050-403 |
| 11.0cm/4.25in | B/B, Curved | 050-404 |
| 11.0cm/4.25in | S/S, Straight | 050-405 |
| 11.0cm/4.25in | B/B, Straight | 050-406 |
| 11.0cm/4.25in | B/B, Straight | 050-711SC |
| 11.0cm/4.25in | B/B, Curved | 050-712SC |

 **Add SR**

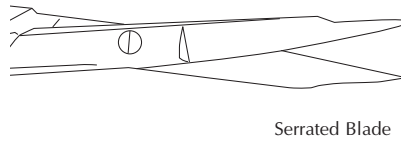

Serrated Blade

050-452SC

The next largest size in tenotomy scissors with strong, serrated blades

Goldman-Fox

| Length | Straight | Curved |
|---------------|----------------|------------------|
| 13.0cm/5.25in | 050-451 | 050-452 |
| 13.0cm/5.25in | | 050-452SC |

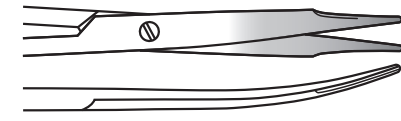
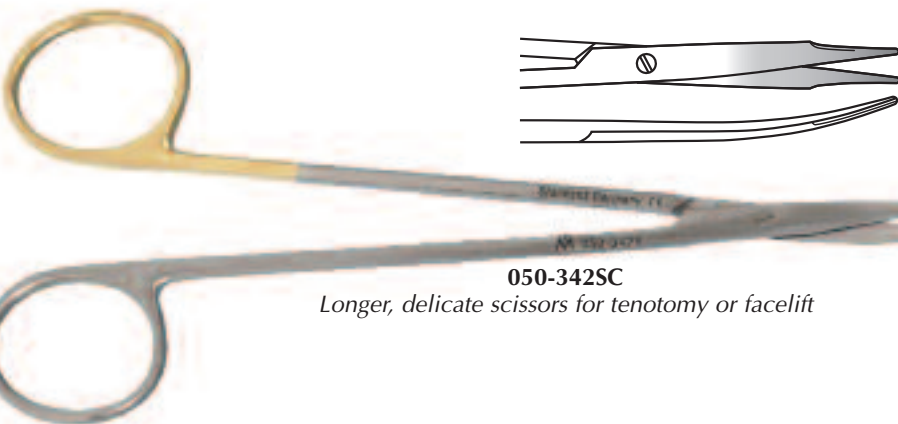

050-342SC

Longer, delicate scissors for tenotomy or facelift

Reynolds

| Length | Straight | Curved |
|--------------|----------------|------------------|
| 15.0cm/6.0in | 050-340 | 050-342 |
| 18.0cm/7.0in | 050-344 | 050-346 |
| 18.0cm/7.0in | | 050-342SC |

 **Add SR**

Stitch Removal Series

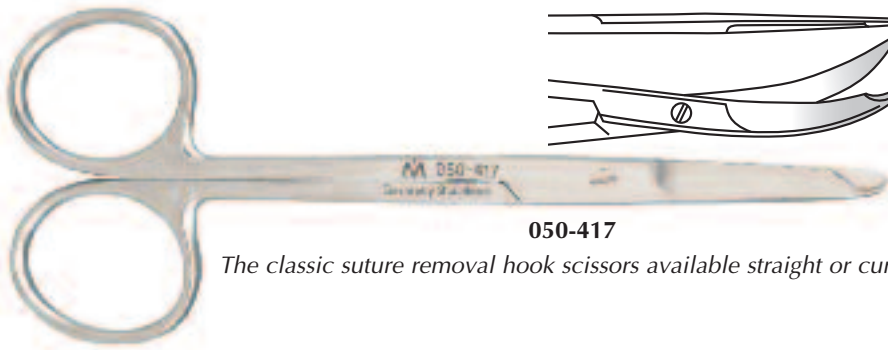

050-417

The classic suture removal hook scissors available straight or curved

Spencer Stitch Removal

| Length | Straight | Curved |
|--------------|----------------|----------------|
| 9.0cm/3.5in | 050-414 | 050-415 |
| 12.5cm/5.0in | 050-417 | 050-418 |



050-320

The newest suture removal scissors with fine angled 15mm blades

O'Brien Stitch Removal

| Length | Product No. |
|--------------|----------------|
| 10.0cm/4.0in | 050-320 |

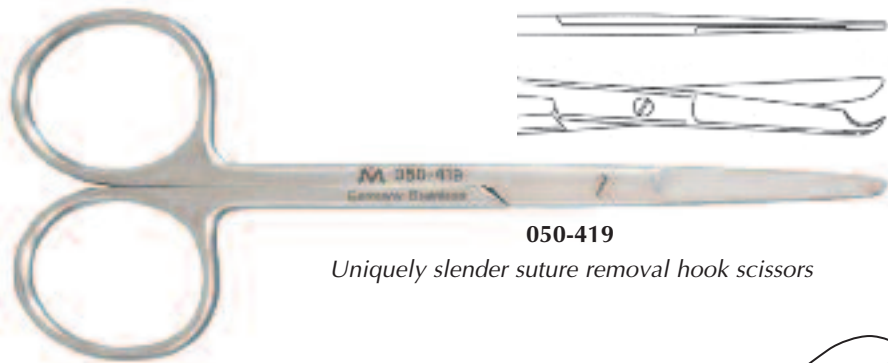

050-419

Uniquely slender suture removal hook scissors

Littauer Stitch Removal

(more delicate)

| Length | Product No. |
|--------------|----------------|
| 14.0cm/5.5in | 050-419 |

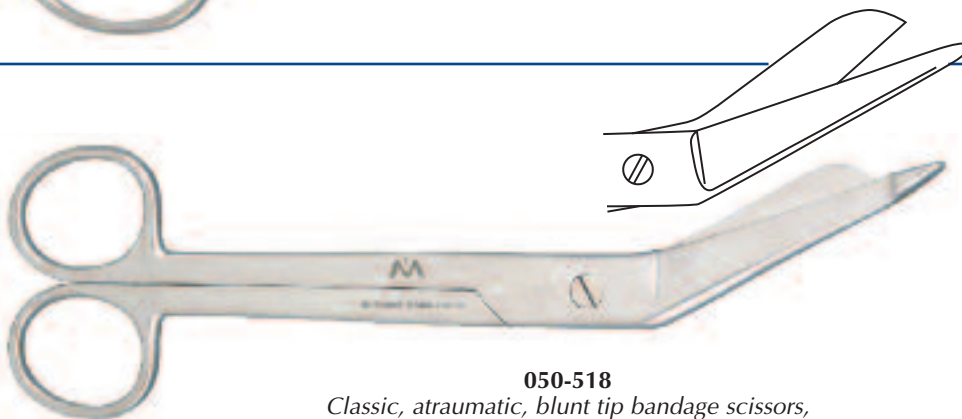

050-518

Classic, atraumatic, blunt tip bandage scissors, 5 different lengths available

Lister Bandage

| Length | Product No. |
|--------------|----------------|
| 9.0cm/3.5in | 050-510 |
| 11.5cm/4.5in | 050-512 |
| 14.0cm/5.5in | 050-514 |
| 18.0cm/7.0in | 050-516 |
| 20.0cm/8.0in | 050-518 |



Add **SR**

MARINA MEDICAL SCISSORS - Nasal Series

German Stainless Steel

Marina Medical can sharpen, tighten, or serrate any scissors for you. If you do not find what you are looking for in this catalog, please contact a customer service representative to assist you.

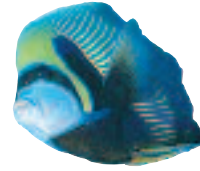

Categories

-  **Stainless**
-  **Supercut**
-  **Tungsten Gold**
-  **Serrated (add SR)**

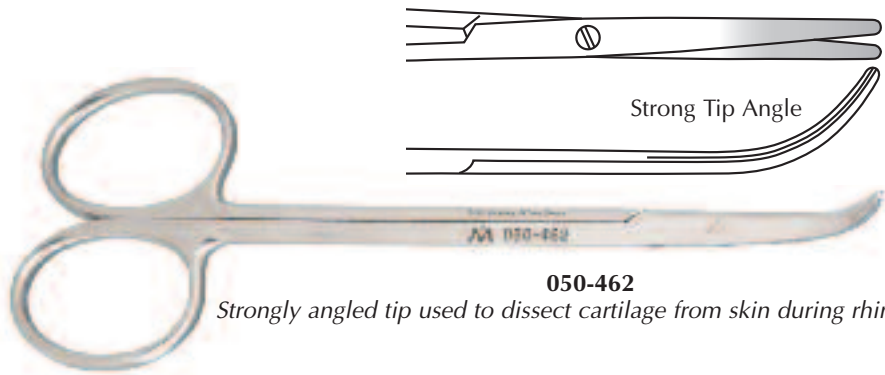

050-462
Strongly angled tip used to dissect cartilage from skin during rhinoplasty

Fomon Lower Lateral Alar

14.0cm/5.5in

050-462



Add **SR**

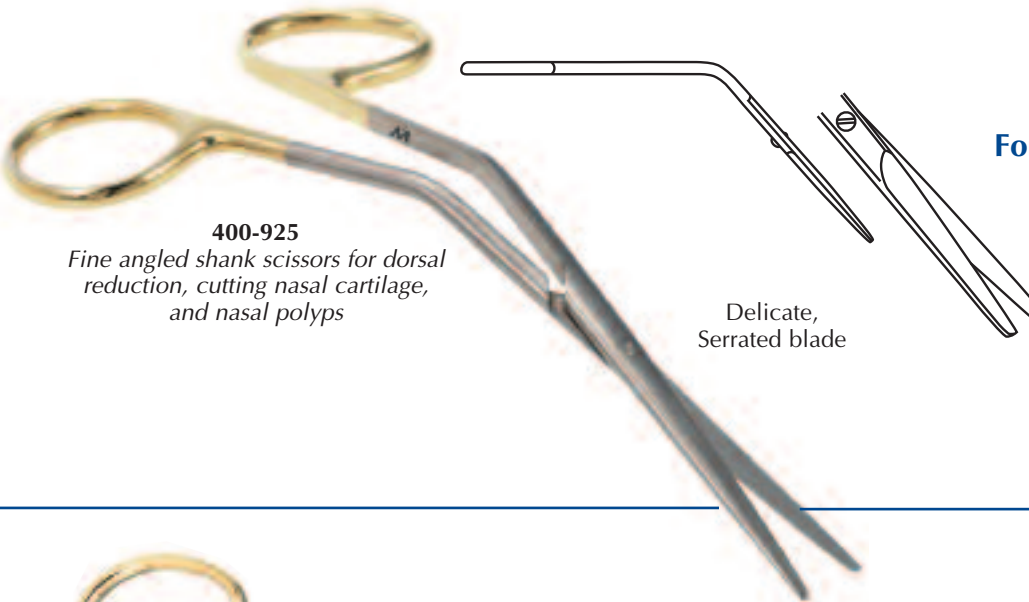

400-925
Fine angled shank scissors for dorsal reduction, cutting nasal cartilage, and nasal polyps

Delicate,
Serrated blade

Fomon Dorsal Angled Shanks

14.0cm/5.5in

050-460



400-925

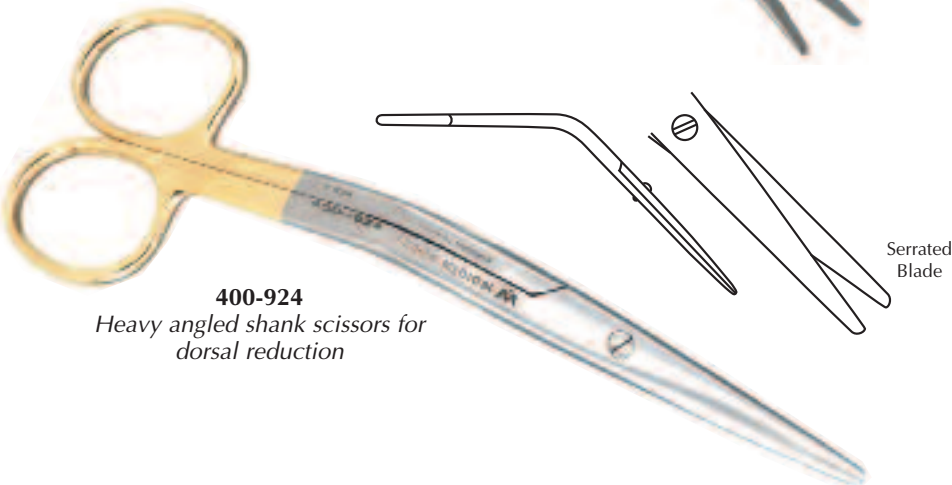

400-924
Heavy angled shank scissors for dorsal reduction

Serrated
Blade

Cottle Dorsal Angled Shanks

16.0cm/6.25in

050-466



400-924



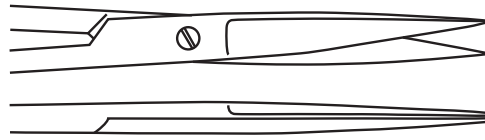
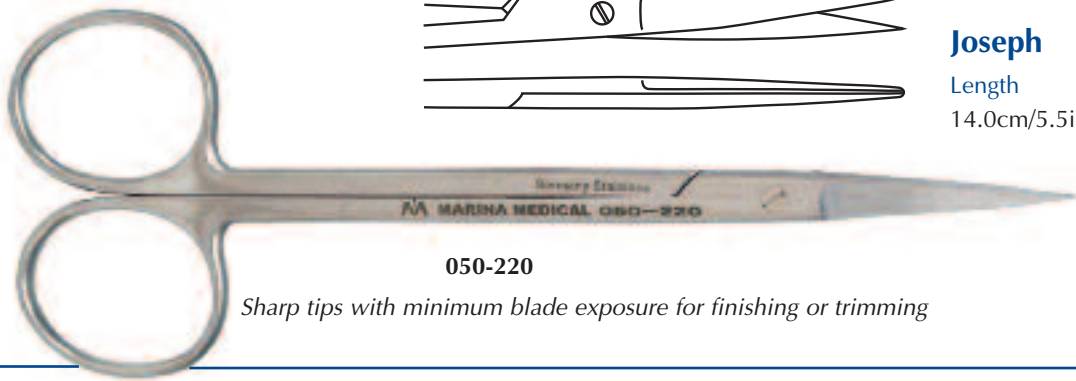

Joseph

Length
14.0cm/5.5in

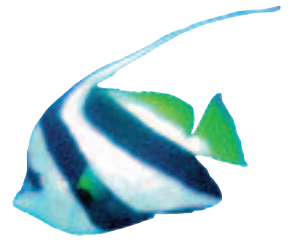

| | |
|----------------|----------------|
| Straight | Curved |
| 050-220 | 050-221 |
| | |

Add **SR**

050-220

Sharp tips with minimum blade exposure for finishing or trimming

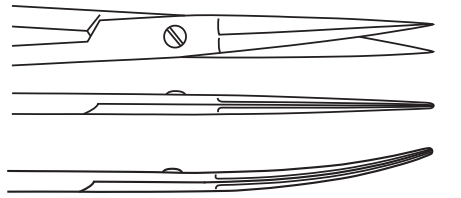
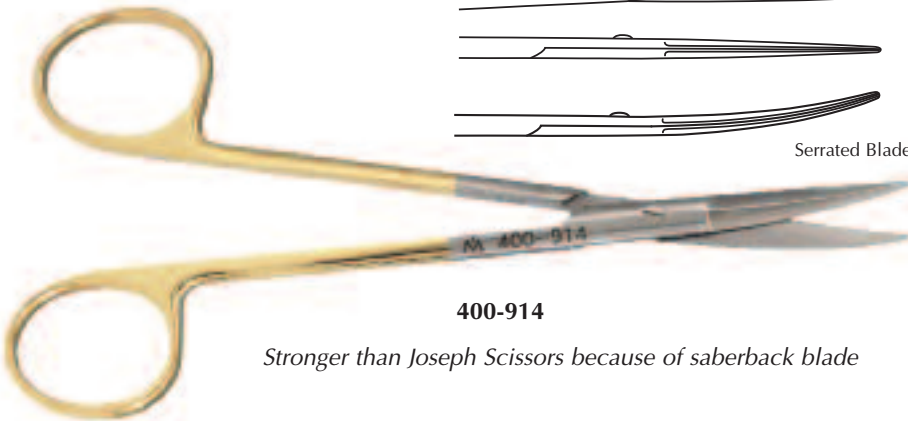

Serrated Blade

Peck-Joseph

Length
14.0cm/5.5in

| | |
|----------------|----------------|
| Straight | Curved |
| 050-224 | 050-226 |
| | |

400-914

400-914

Stronger than Joseph Scissors because of saberback blade

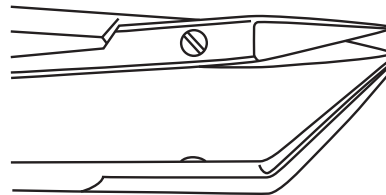
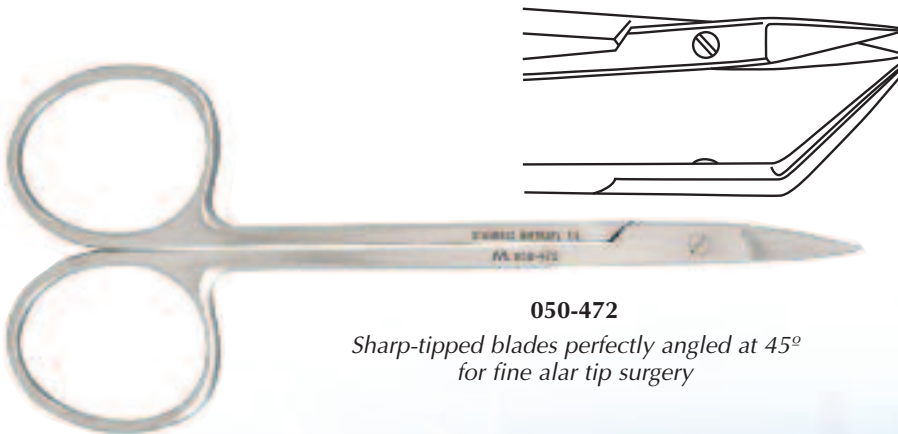

Wilmer (Converse) Angled on Flat

Length
10.0cm/4.0in

Product No.
050-472

Add **SR**

050-472

Sharp-tipped blades perfectly angled at 45° for fine alar tip surgery





MARINA MEDICAL SCISSORS - Rhytidectomy Scissors

German Stainless Steel

Each Rhytidectomy Scissors comes with serrated blades.



400-929
Saberback, strong cutting,
many lengths available

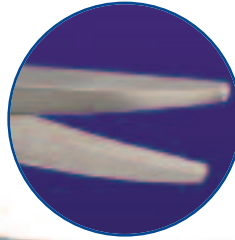

Kaye

Description

Curved, 11.5cm/4.5in
Curved, 16.5cm/6.5in
Curved, 14.0cm/5.5in

Product No.

400-928
400-929
400-932

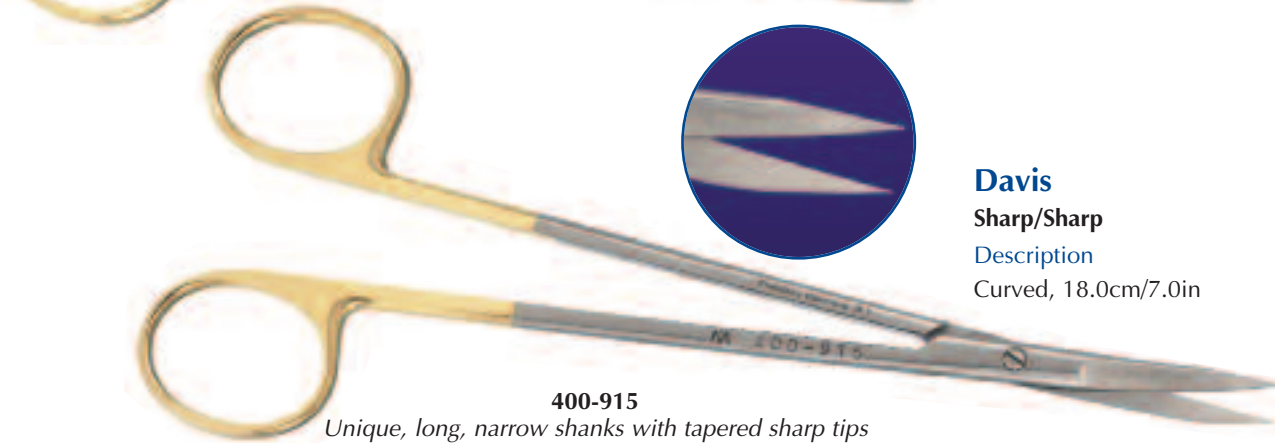

400-915
Unique, long, narrow shanks with tapered sharp tips

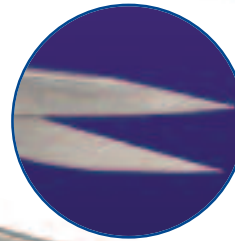

Davis

Sharp/Sharp

Description

Curved, 18.0cm/7.0in

Product No.

400-915

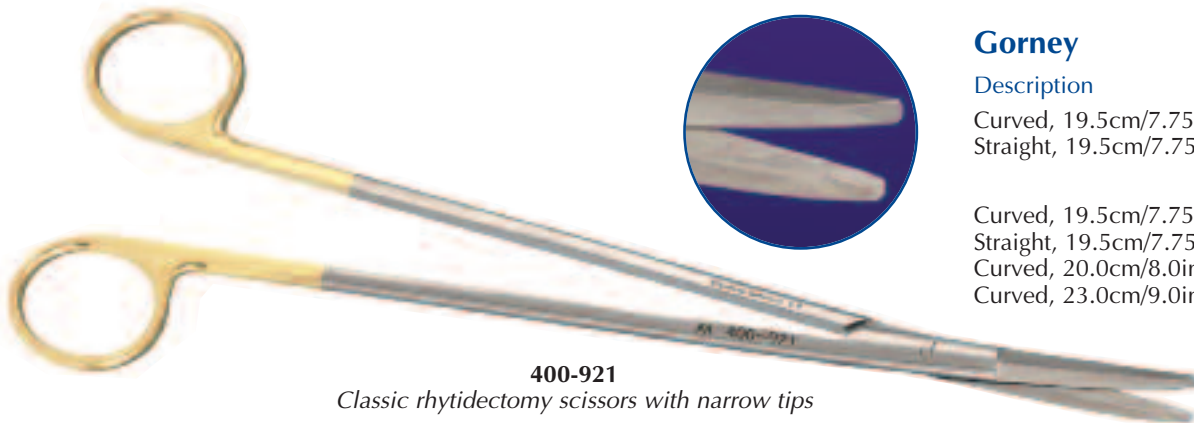

400-921
Classic rhytidectomy scissors with narrow tips

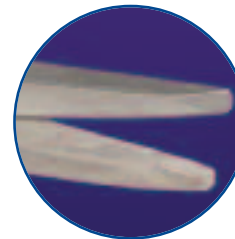

Gorney

Description

Curved, 19.5cm/7.75in
Straight, 19.5cm/7.75in

Product No.

050-473
050-474



Curved, 19.5cm/7.75in
Straight, 19.5cm/7.75in
Curved, 20.0cm/8.0in
Curved, 23.0cm/9.0in

400-918
400-919
400-920
400-921

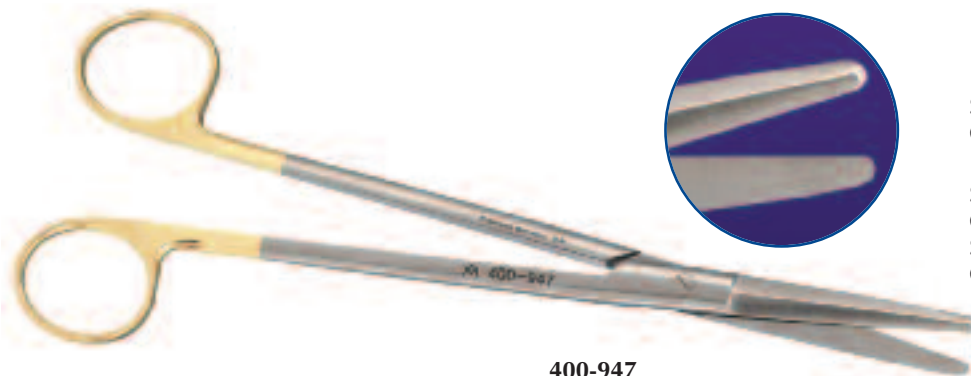

400-947
Broader shanks for stronger cutting

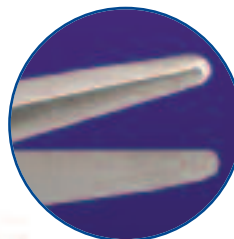

Rees

Description

Straight, 16.5cm/6.5in
Curved, 16.5cm/6.5in

Product No.

050-457
050-456



Straight, 16.5cm/6.5in
Curved, 16.5cm/6.5in
Straight, 20.0cm/8.0in
Curved, 20.0cm/8.0in

400-937
400-938
400-947
400-948



Marina Medical precise-cut Rhytidectomy scissors are offered in a wide selection of patterns. For use in various surgical procedures. Our precise-cut scissors are precision machined and handcrafted for longtime performance. Each scissors is finely balanced for accurate cutting and dissecting. Our guarantee to you is that each scissors will have excellent cutting action and long-lasting sharpness.

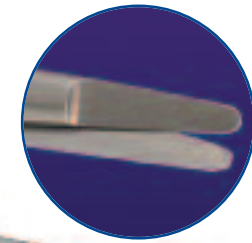
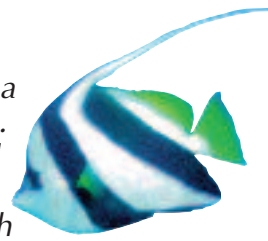

400-917

Hand rings do not close flush when blades are closed, giving greater leverage and reducing fatigue

Freeman

Description

Curved, 17.5cm/6.75in

Straight, 18.0cm/7.0in

Curved, 18.0cm/7.0in

Product No.

050-467



400-916

400-917

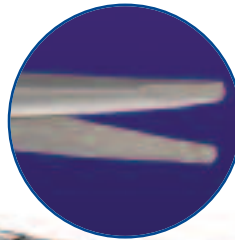

400-926

Kaye tips with Freeman hand rings

Freeman-Kaye

Description

Curved, 18.0cm/7.0in

Straight, 18.0cm/7.0in

Product No.

400-926

400-926S

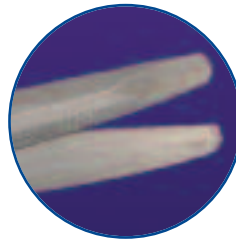
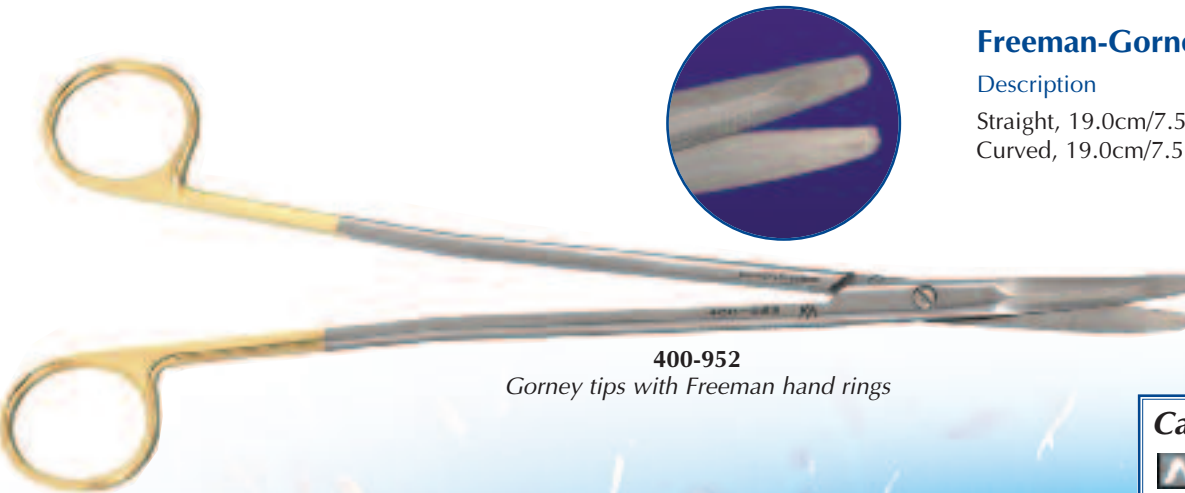

400-952

Gorney tips with Freeman hand rings

Freeman-Gorney

Description

Straight, 19.0cm/7.5in

Curved, 19.0cm/7.5in

Product No.

400-950

400-952



Categories



Stainless



Supercut



Tungsten Gold



Serrated (add SR)

MARINA MEDICAL SCISSORS - *Micro Scissors*

German Stainless Steel

Spring-action scissors provide greater control for microsurgery.

170-121

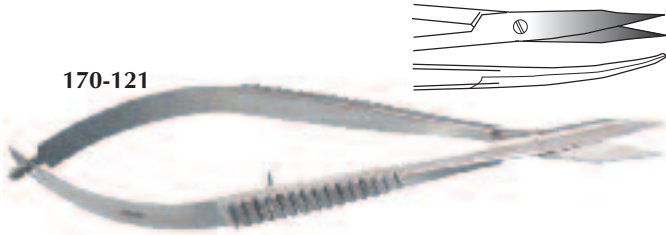

Durable, delicate blades for cutting tissue and suture

Westcott Utility

| Description | Straight | Curved |
|------------------------------|----------------|----------------|
| 10.0mm blades, 11.0cm/4.25in | 170-121 | 170-122 |

Add **SR**

170-124



Delicate blades for cutting delicate suture and tissue

Westcott Stitch

| Description | Straight | Curved |
|--------------------------------|----------------|----------------|
| Delicate blades, 12.0cm/4.75in | 170-124 | 170-125 |

Add **SR**

170-128



Cuts delicate eye tissue. Also used to cut fine suture

Vannas

| Description | Straight | Curved |
|---------------------------|----------------|----------------|
| 5.0mm blades, 7.5cm/3.0in | 170-126 | 170-128 |

Add **SR**

170-130

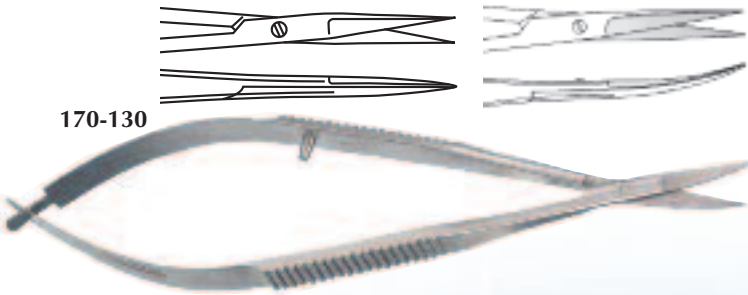

For conjunctival dissection

Castroviejo

| Description | Curved S/S | Curved B/B |
|----------------------------|----------------|----------------|
| 8.0mm blades, 10.0cm/4.0in | 170-130 | 170-131 |

Add **SR**



PREFERRED CUSTOMER CLUB

START EARNING YOUR VALUABLE POINTS TODAY!

Dressing & Tissue Forceps

Jeweler Forceps

Specialty Forceps

Suture Removal Forceps

Hemostatic Clamps

Towel Clips

FORCEPS & CLAMPS

FORCEPS & CLAMPS - Dressing & Tissue Forceps



Dressing Forceps

No teeth, serrations

| Product No. | Length |
|----------------|----------------------|
| 060-004 | 11.5cm/4.5in |
| 060-005 | 11.5cm/4.5in, Curved |
| 060-006 | 12.5cm/5.0in |
| 060-008 | 14.5cm/5.75in |
| 060-010 | 16.0cm/6.25in |
| 060-012 | 18.5cm/7.25in |
| 060-014 | 20.0cm/8.0in |
| 060-016 | 25.5cm/10.0in |
| 060-018 | 30.0cm/11.75in |



Tissue (Pick-up) Forceps

1 x 2 teeth, no serrations

| Product No. | Length |
|----------------|---------------|
| 060-040 | 11.5cm/4.5in |
| 060-042 | 12.5cm/5.0in |
| 060-044 | 14.5cm/5.75in |
| 060-046 | 16.0cm/6.25in |
| 060-047 | 17.5cm/7.0in |
| 060-048 | 20.0cm/8.0in |
| 060-050 | 25.5cm/10.0in |
| 060-053 | 30.5cm/12.0in |



Semken Forceps

Very delicate tip, 1.0mm

No teeth

| Product No. | Length |
|----------------|--------------|
| 060-058 | 15.0cm/6.0in |

1 x 2 teeth

| Product No. | Length |
|----------------|--------------|
| 060-060 | 15.0cm/6.0in |

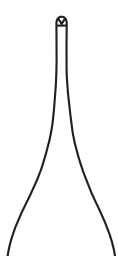

Adson Tissue



Adson Dressing

Adson Forceps

Without teeth, serrated tips

| Product No. | Description - Length |
|----------------|--|
| 060-117 | Delicate, Straight - 1.5mm tip - 12.0cm/4.75in |
| 060-120 | Straight - 2.0mm tip - 12.0cm/4.75in |
| 060-121 | Fenestrated Handle, 2mm tip - 12.0cm/4.75in |
| 060-125 | Straight, 2.0mm tip - 15.0cm/6.0in |

With teeth

| Product No. | Description - Length |
|----------------|---|
| 060-130 | 1 x 2, Smooth, 2.0mm tip, Straight - 12.0cm/4.75in |
| 060-131 | 1 x 2, Fenestrated Handle, Straight - 2.0mm tip - 12.0cm/4.75in |
| 060-132 | 1 x 2, Straight - 2.0mm tip - 15.0cm/6.0in |
| 060-134 | 1 x 2, Delicate, 1.5mm tip, Straight - 12.0cm/4.75in |
| 060-140 | 1 x 2, Smooth, 2.0mm tip, Curved - 12.0cm/4.75in |
| 060-150 | 2 x 3, Smooth, 3.0mm, Straight - 12.0cm/4.75in, |

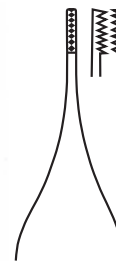

Adson-Brown Forceps

7 x 7 Teeth, 2.0mm tip

| Product No. | Description - Length |
|----------------|------------------------------------|
| 060-170 | Standard - 12.0cm/4.75in |
| 060-171 | Fenestrated Handle - 12.0cm/4.75in |
| 060-174 | Standard - 15.0cm/6.0in |
| 060-172 | Angled - 12.0cm/4.75in |



Adson Dressing



Adson Tissue



Adson DeBakey

Adson Forceps w/ Tying Platform

Without teeth

| Product No. | Description - Length |
|----------------|---|
| 060-126 | Standard 2.0mm tip, Serrated - 12.0cm/4.75in |
| 060-128 | Delicate, 1.5mm tip, Serrated - 12.0cm/4.75in |

With teeth

| Product No. | Description - Length |
|----------------|---|
| 060-136 | 1 x 2 Teeth, Smooth, 2.0mm tip - 12.0cm/4.75in |
| 060-137 | 1 x 2 Teeth, Serrated, 2.0mm tip - 12.0cm/4.75in |
| 060-138 | 1 x 2 Teeth, Serrated, Delicate, 1.5mm tip - 12.0cm/4.75in |
| 060-160 | Adson w/ DeBakey Teeth - 12.0cm/4.75in, atraumatic, 2.0mm jaw |

Marina Medical will coat any forceps with long-lasting non-conductive nylon coating. Please add **NC** after the product number for your non-conductive instrument.



440-212

Adson Forceps

Tungsten Carbide

| Product No. | Description - Length |
|-------------|--|
| 440-212 | Smooth Platform, TC tips, No Teeth - 12.0cm/4.75in |
| 440-214 | Delicate Serrated Platform, TC tips, No Teeth - 12.0cm/4.75in |
| 440-312 | Serrated Platform, 1 x 2 Teeth, TC tips -12.0cm/4.75in |
| 440-315 | Delicate, Serrated Platform, TC tips, No Teeth - 15.0cm/6.0in |
| 440-316 | 1 x 2 Teeth, Delicate Serrated Platform, TC tips - 12.0cm/4.75in |
| 440-317 | 1 x 2 Teeth, Delicate Serrated Platform, TC tips - 15.0cm/6.0in |



310-228

330-218

Non-conductive

Potts-Smith Forceps



Dressing
(No teeth), 2.0mm Jaw

| Product No. |
|-------------|
| 060-218 |
| 060-221 |
| 060-224 |

with Non-conductive Coating

| Product No. | Length |
|-------------|---------------|
| 310-218 | 18.0cm/7.0in |
| 310-221 | 21.0cm/8.25in |
| 310-224 | 24.0cm/9.5in |

Tissue, 1 x 2 Teeth, 2.0mm Jaw

| Product No. |
|-------------|
| 060-228 |
| 060-231 |
| 060-234 |

| Product No. | Length |
|-------------|---------------|
| 310-228 | 18.0cm/7.0in |
| 310-231 | 21.0cm/8.25in |
| 310-234 | 24.0cm/9.5in |

Iris (Graefe) Forceps



Add **NC** for non-conductive coating

Serrated, no teeth

Length

10.0cm/4.0in (Iris)
7.0cm/2.75in (Graefe)

| Product No. | Product No. | Product No. |
|-------------|-------------|-------------|
| 060-400 | 060-402 | 060-404 |
| 060-406 | 060-408 | |

1 x 2 teeth

Length

10.0cm/4.0in (Iris)
7.0cm/2.75in (Graefe)

| Product No. | Product No. | Product No. |
|-------------|-------------|-------------|
| 060-410 | 060-411 | 060-412 |
| 060-414 | 060-416 | |

DeBakey Tissue Forceps



Add **NC** for non-conductive coating

| Jaw Width | Product No. | Product No. |
|-----------|-------------|-------------|
| 1.5mm | 060-510 | 060-520 |
| 2.0mm | 060-512 | 060-522 |
| | 060-514 | 060-524 |
| | 060-516 | 060-526 |

Length

15.0cm/6.0in
19.5cm/7.75in
24.0cm/9.5in
30.0cm/11.75in

Jaw Width

1.5mm 2.0mm

| Product No. | Product No. |
|-------------|-------------|
| 060-510 | 060-520 |
| 060-512 | 060-522 |
| 060-514 | 060-524 |
| 060-516 | 060-526 |



FORCEPS & CLAMPS - *Bi-Polar Forceps*

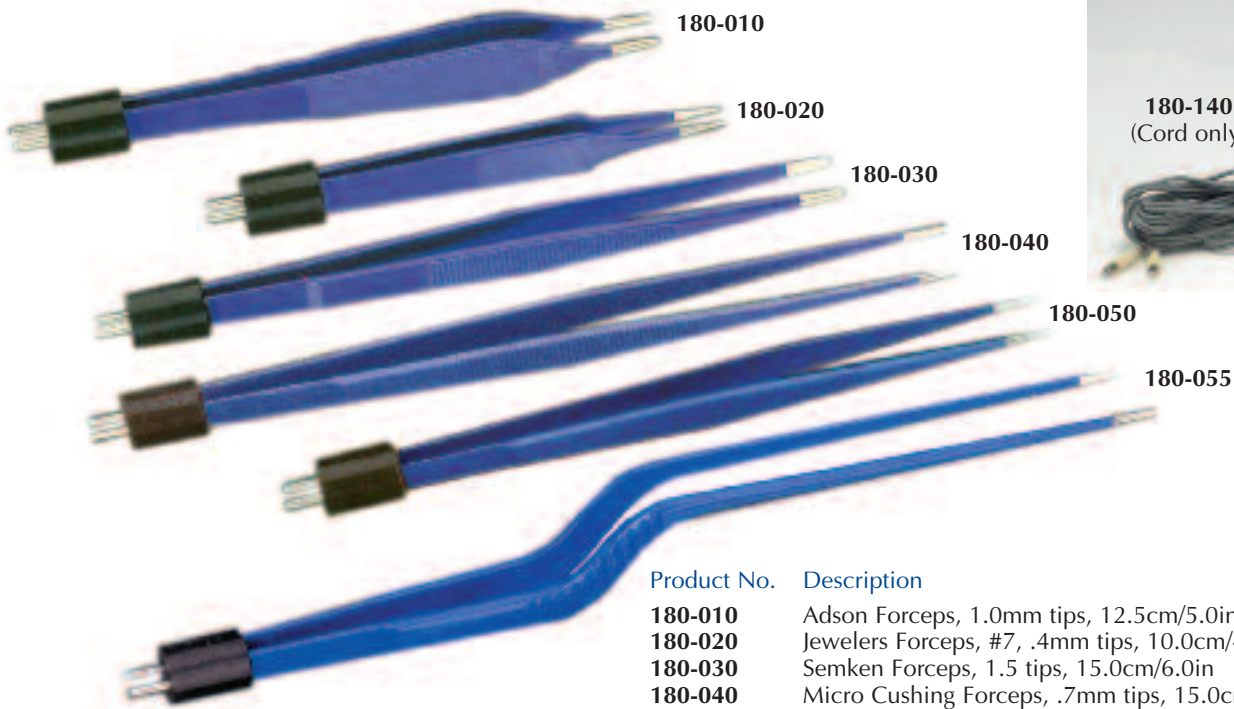

Many other styles available. Please ask.

| Product No. | Description |
|-------------|--|
| 180-010 | Adson Forceps, 1.0mm tips, 12.5cm/5.0in |
| 180-020 | Jewelers Forceps, #7, .4mm tips, 10.0cm/4.0in |
| 180-030 | Semken Forceps, 1.5 tips, 15.0cm/6.0in |
| 180-040 | Micro Cushing Forceps, .7mm tips, 15.0cm/6.0in |
| 180-050 | Cushing Forceps, 1.5mm tips, 18.0cm/7.0in |
| 180-055 | Bayonet Forceps, 1.0mm tips, 18.5cm/7.25in |
| 180-140 | Bi-Polar Cord, 12 feet, Reusable |

Jeweler Forceps

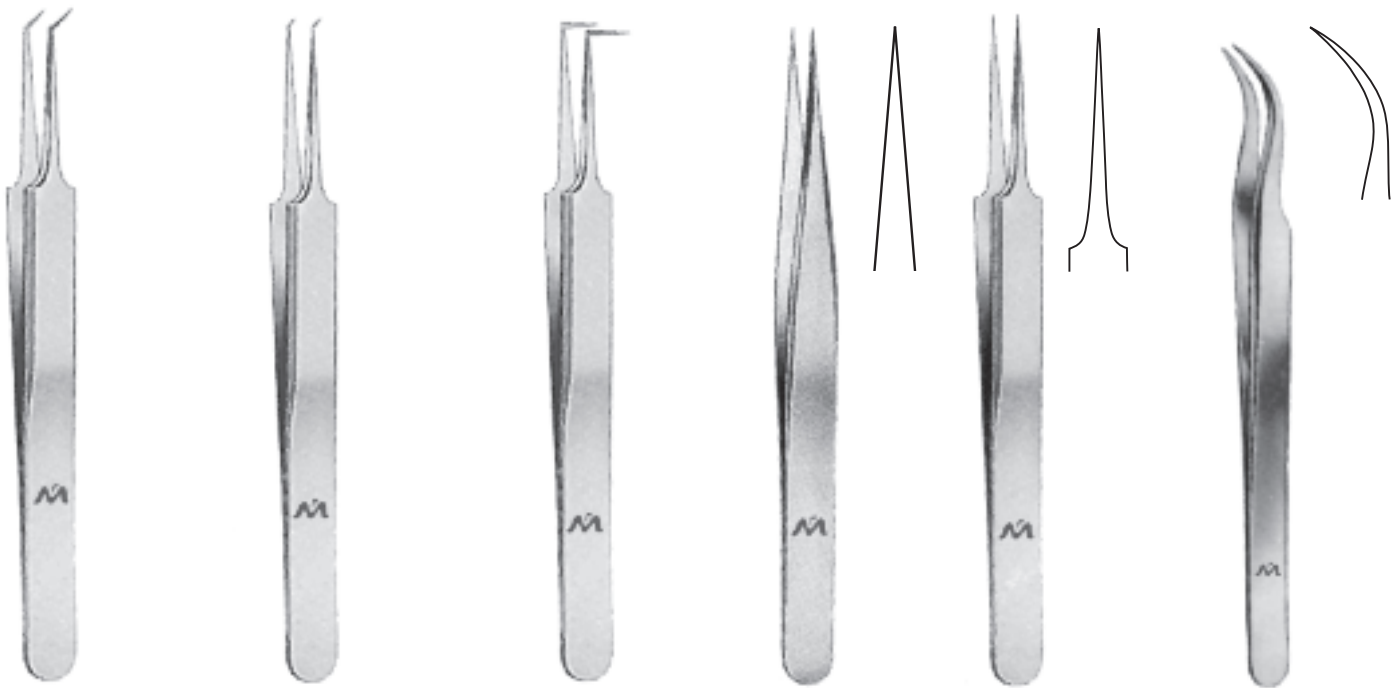

Jeweler Forceps for Hair Restoration

45° Angle Tip
11.0cm/4.25in
Product No.
060-330

45° Angle Tip, Delicate
11.0cm/4.25in
Product No.
060-331

90° Angle Tip
11.0cm/4.25in
Product No.
060-332

#3, Straight
12.0cm/4.75in
Product No.
060-336

#5
12.0cm/4.75in
Product No.
060-338

#7, Angled
12.0cm/4.75in
Product No.
060-340

Specialty Forceps

Blepharoplasty Forceps



440-323 440-319 440-321

Extra Fine
Product No.
440-323

Description
Extra Fine Hooks on
Castroviejo Forceps,
12.0cm/4.75in

Delicate
Product No.
440-319

Description
Delicate Hooks on
Adson Forceps,
13.0cm/5.0in

Standard
Product No.
440-321
Description
Standard Hooks on
Adson Forceps with Platform
13.0cm/5.0in



Green Fixation Forceps

Product No.
060-430

Description
With lock, 10mm tip. Grips tissue in
an atraumatic manner. Great for
Blepharoplasty procedures.
10.5cm/4.0in

060-420 - Without lock, 10mm tip



Griffith Brown Forceps

Product No.
060-183

Description - Length
Delicate 9 x 9 Teeth on
Castroviejo Forceps - 11.5cm/4.75in

Micro Forceps



Castroviejo Suturing Forceps

w/ Tying Platform, 1 x 2 teeth
10.0cm/4.0in

| Product No. | Description |
|----------------|-------------|
| 171-612 | .12mm teeth |
| 171-630 | .3mm teeth |
| 171-650 | .5mm teeth |
| 171-690 | .9mm teeth |



Tubingen Tying Forceps

Smooth Platform
10.0cm/4.0in

| Product No. | Description |
|----------------|-------------|
| 171-600 | No teeth |

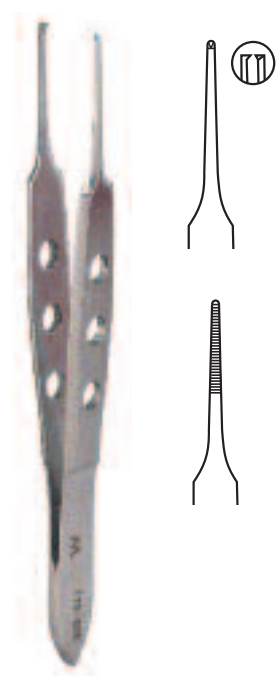

Bishop-Harmon Suture Forceps

9.0cm/3.5in

| Product No. | Description |
|----------------|--------------------|
| 173-825 | 1 x 2, .5mm teeth |
| 173-828 | 1 x 2, .8mm teeth |
| 173-829 | No teeth, .8mm tip |



FORCEPS & CLAMPS - *Splinter & Suture Removal Forceps*

Used to Remove Sutures, Cilia or Splinters



Feilchenfeld Splinter Forceps

Product No. Description
190-134 12.0cm/4.75in



Virtus Splinter Forceps

Product No. Description
190-136 15.0cm/6.0in



Carmalt Splinter Forceps

Product No. Description
190-137 Angled, 11.0cm/4.25in
190-138 Straight, 11.0cm/4.25in



Littauer Cilia Forceps, Flat

9.0cm/3.5in
Product No.
190-128



Littauer Cilia Forceps, Oblique

9.0cm/3.5in
Product No.
190-129



Swiss Cilia Forceps, Oblique

9.0cm/3.5in
Product No.
060-342



Marina Splinter Forceps

10.0cm/4.0in
Product No.
190-143



Barraquer (Kurth) Forceps

with Tying Platform
10.0cm/4.0in
Product No.
060-341

Specialty Forceps

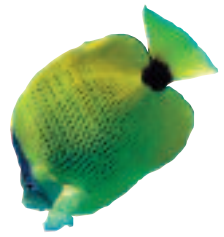

Add **NC**
for non-
conductive
coating

Jansen Bayonet

20.0cm/8.0in
060-344



Add **NC**
for non-
conductive
coating

Taylor

18.0cm/7.0in - No teeth
060-345



Add **NC**
for non-
conductive
coating

Taylor Bayonet

18.0cm/7.0in
060-346 - No teeth
060-347 - 1 x 2 teeth



Add **NC**
for non-
conductive
coating

Cushing

17.0cm/6.75in
060-360 - no teeth
060-361 - 1 x 2 teeth

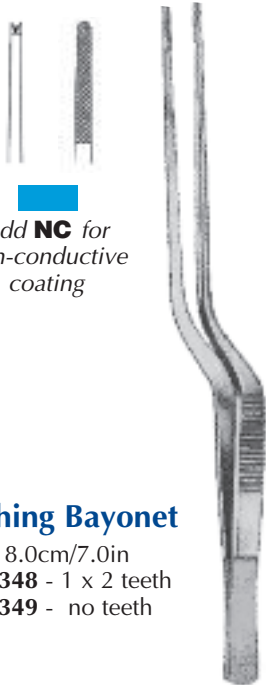

Add **NC**
for non-
conductive
coating

Cushing Bayonet

18.0cm/7.0in
060-348 - 1 x 2 teeth
060-349 - no teeth

Add **NC**
for non-
conductive
coating



Wilde

12.5cm/5in
060-354



Add **NC**
for non-
conductive
coating

Lucae

Bayonet style
060-350 - 14.0cm/5.5in
060-352 - 16.0cm/6.5in



Allis Clamps

Baby Allis

| Product No. | Description |
|----------------|---------------------------|
| 160-005 | 4 x 5 teeth, 12.0cm/4.5in |

Allis

| Product No. | Description |
|----------------|---------------------------|
| 160-013 | 3 x 4 teeth, 13.0cm/5.0in |
| 160-114 | 4 x 5 teeth, 14.5cm/5.5in |
| 160-115 | 4 x 5 teeth, 15.0cm/6.0in |
| 160-215 | 5 x 6 teeth, 15.0cm/6.0in |

FORCEPS & CLAMPS - Hemostatic Clamps



Kelly (Kelly-Rankin)

| Product No. | Description |
|-------------|-------------------------|
| 070-036 | Straight, 14.0cm/5.5in |
| 070-038 | Curved, 14.0cm/5.5in |
| 070-037 | Straight, 16.0cm/6.25in |
| 070-039 | Curved, 16.0cm/6.25in |



Crile (Crile-Rankin)

| Product No. | Description |
|-------------|-------------------------|
| 070-042 | Straight, 14.0cm/5.5in |
| 070-044 | Curved, 14.0cm/5.5in |
| 070-043 | Straight, 16.0cm/6.25in |
| 070-045 | Curved, 16.0cm/6.25in |



Halsted Mosquito (Adson)

| Product No. | Description |
|-------------|----------------------|
| 070-330 | Curved, 20.0cm/8.0in |



Rochester-Pean

| Product No. | Description |
|-------------|-------------------------|
| 070-120 | Straight, 16.0cm/6.25in |
| 070-122 | Straight, 18.0cm/7.0in |
| 070-124 | Straight, 20.0cm/8.0in |
| 070-138 | Curved, 16.0cm/6.25in |
| 070-140 | Curved, 18.0cm/7.0in |
| 070-142 | Curved, 20.0cm/8.0in |

Longer sizes available



Mixer

Strongly Curved

| Product No. | Description |
|-------------|---------------|
| 070-340 | 14.0cm/5.5in |
| 070-341 | 16.0cm/6.25in |
| 070-342 | 19.0cm/7.5in |
| 070-344 | 23.5cm/9.0in |



Rochester-Oschner (Kocher)

| Product No. | Description |
|-------------|--|
| 070-066 | Straight, 1 x 2 Teeth, 14.0cm/5.5in (Kocher) |
| 070-068 | Curved, 1 x 2 Teeth, 14.0cm/5.5in (Kocher) |
| 070-152 | Straight, 1 x 2 Teeth, 18.0cm/7.0in |
| 070-154 | Straight, 1 x 2 Teeth, 20.0cm/8.0in |
| 070-162 | Curved, 1 x 2 Teeth, 18.0cm/7.0in |
| 070-164 | Curved, 1 x 2 Teeth, 20.0cm/8.0in |

Longer sizes available

Hemostatic Forceps

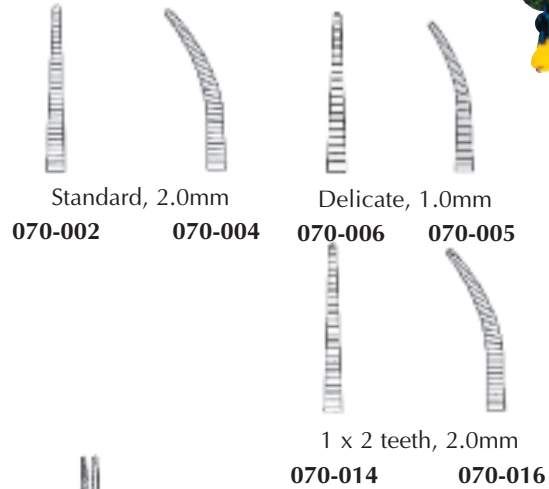
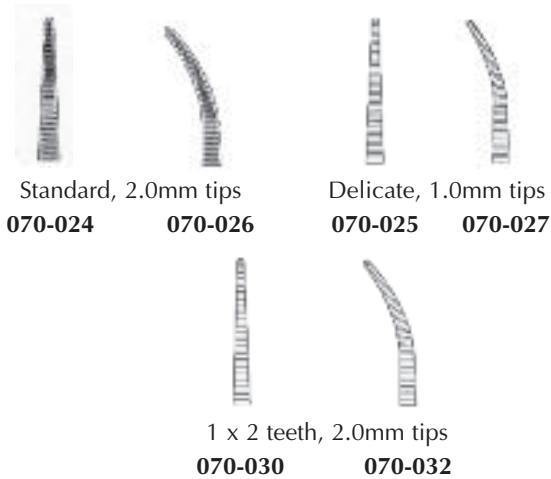

Hartman Mosquito

10cm/4in

| Product No. | Description |
|-------------|-----------------------|
| 070-024 | Straight |
| 070-025 | Straight, Delicate |
| 070-026 | Curved |
| 070-027 | Curved, Delicate |
| 070-030 | Straight, 1 x 2 Teeth |
| 070-032 | Curved, 1 x 2 Teeth |



Halsted Mosquito

13.0cm/5.25in

| Product No. | Description |
|-------------|-----------------------|
| 070-002 | Straight |
| 070-004 | Curved |
| 070-005 | Curved, Delicate |
| 070-006 | Straight, Delicate |
| 070-014 | Straight, 1 x 2 Teeth |
| 070-016 | Curved, 1 x 2 Teeth |

18.0cm/7.0in
070-240 Baby Adson, Curved

13cm/5.25in
070-007 Halsted (Peet) Angled

Towel Clips



Jones

| Product No. | Description |
|-------------|-------------|
| 070-524 | 9.0cm/3.5in |



Backhaus

| Product No. | Description |
|-------------|---------------|
| 070-504 | 9.0cm/3.5in |
| 070-506 | 13.0cm/5.25in |



Lorna (Edna)

| Product No. | Description |
|-------------|---------------|
| 070-514 | 10.0cm/4.0in |
| 070-515 | 13.0cm/5.25in |

FORCEPS & CLAMPS

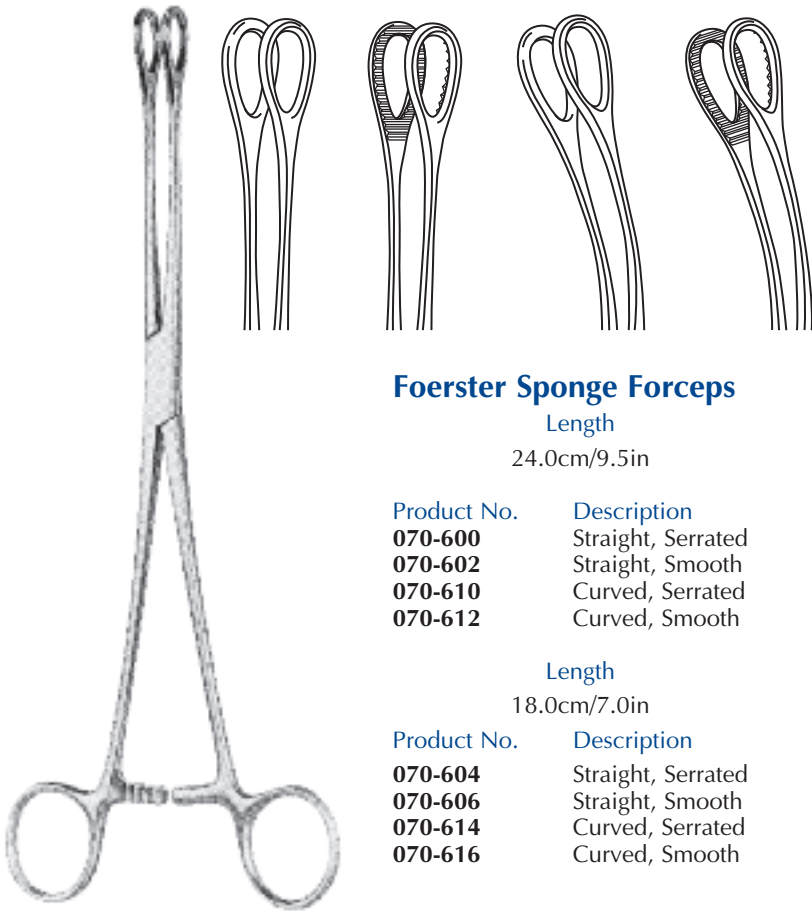

Foerster Sponge Forceps

Length
24.0cm/9.5in

| Product No. | Description |
|-------------|--------------------|
| 070-600 | Straight, Serrated |
| 070-602 | Straight, Smooth |
| 070-610 | Curved, Serrated |
| 070-612 | Curved, Smooth |

Length
18.0cm/7.0in

| Product No. | Description |
|-------------|--------------------|
| 070-604 | Straight, Serrated |
| 070-606 | Straight, Smooth |
| 070-614 | Curved, Serrated |
| 070-616 | Curved, Smooth |

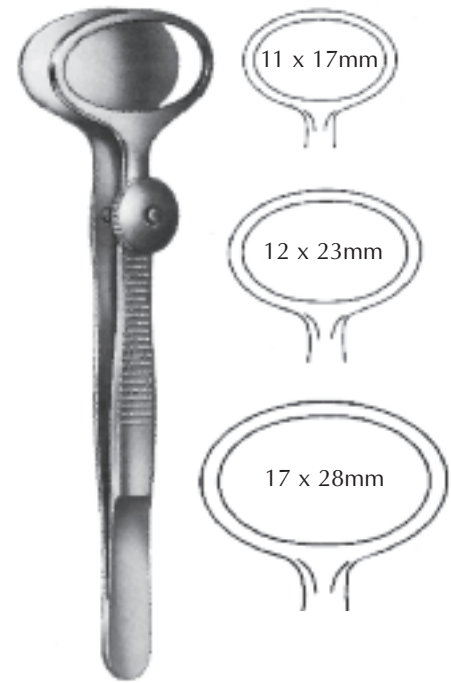

Desmarres Chalazion Clamp

9.0cm/3.5in

| Product No. | Description |
|-------------|-------------|
| 190-601 | Small |
| 190-602 | Medium |
| 190-603 | Large |

Di Geronimo Fill Tube Inserter Clamp

No breast surgeon should be without this handy fill tube inserter clamp. Useful to reinsert the fill tube into the breast implant valve if the fill tube inadvertently slips out during the filling procedure or if after removal more or less saline is desired.

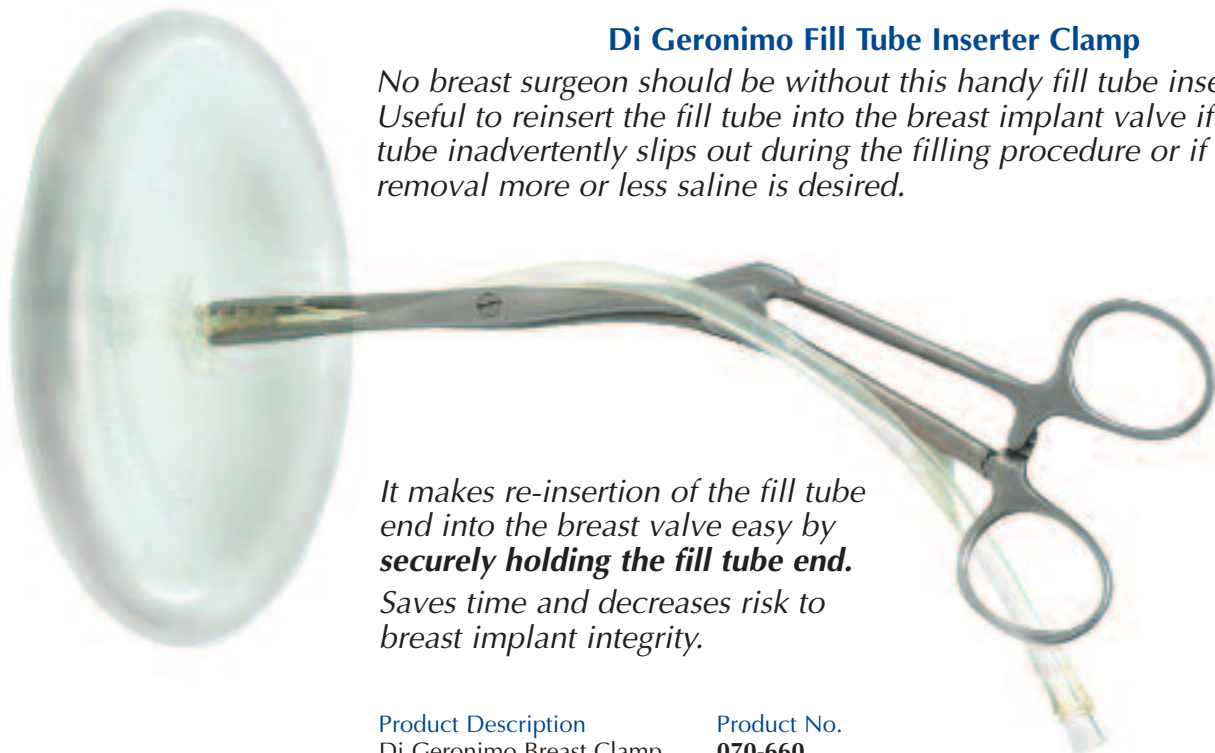

*It makes re-insertion of the fill tube end into the breast valve easy by **securely holding the fill tube end.** Saves time and decreases risk to breast implant integrity.*

| Product Description | Product No. |
|--------------------------|-------------|
| Di Geronimo Breast Clamp | 070-660 |

Standard Needle Holders

Micro Needle Holders

NEEDLE HOLDERS

NEEDLE HOLDERS



Recommended for 4/0 to 6/0 suture

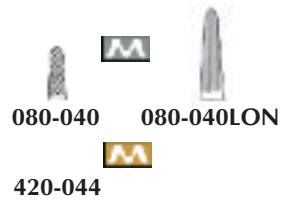

Derf
12.0cm/4.75in

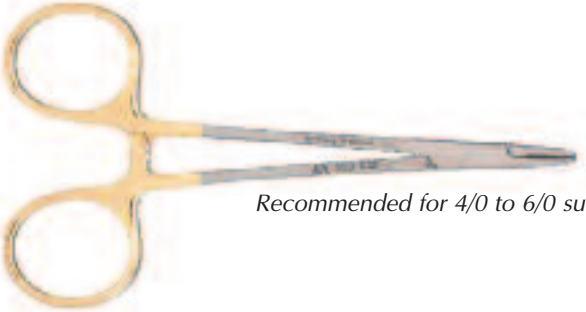

Recommended for 4/0 to 6/0 suture



Baby Webster
12.0cm/4.75in

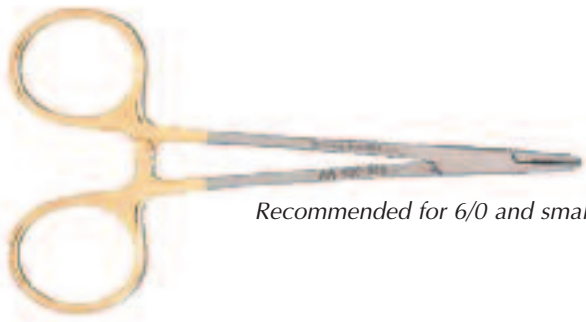

Recommended for 6/0 and smaller suture

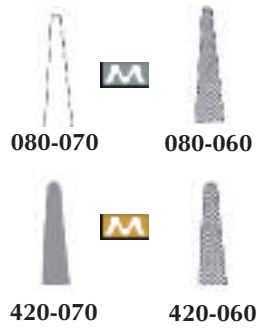

Webster
13.0cm/5.0in



Recommended for 5/0 and smaller suture

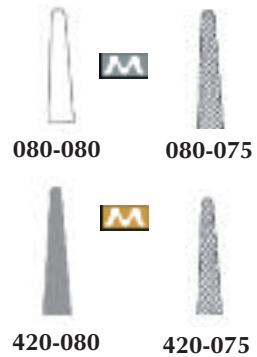

Halsey
13.0cm/5.0in



Recommended for 4/0 to 6/0 suture

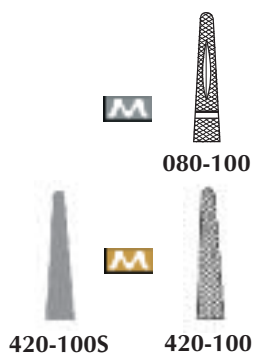

Crilewood
15.0cm/6.0in



Recommended for 4/0 to 6/0 suture



420-211

11.0cm/4.25in



420-210

13.0cm/5.25in



420-213

16.0cm/6.25in



080-250

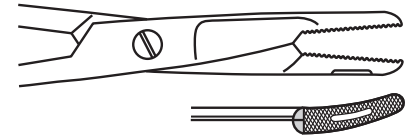

Gillies

16.0cm/6.25in
Needleholder/Scissors combo
with Offset Rings



Recommended for 1/0 to 4/0 suture



Mayo-Hegar

| Product No. | Description |
|-------------|---------------|
| 080-140 | 15.0cm/6.0in |
| 080-160 | 18.0cm/7.0in |
| 080-180 | 20.0cm/8.0in |
| 080-200 | 23.0cm/9.0in |
| 080-220 | 26.5cm/10.5in |

| Product No. | Description |
|-------------|------------------------------|
| 420-314 | 14.0cm/5.5in |
| 420-316 | 16.0cm/6.25in |
| 420-318 | 18.0cm/7.0in |
| 420-320 | 20.0cm/8.0in |
| 420-314LH | 14.0cm/5.5in - Left hand |
| 420-317 | 18.0cm/7.0in - Smooth Jaw |

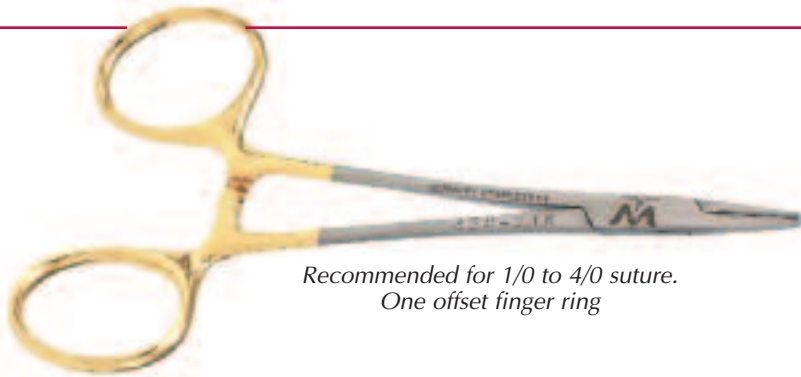

Recommended for 1/0 to 4/0 suture.
One offset finger ring



Neivert

| Product No. | Description |
|-------------|--------------|
| 080-216 | 13.0cm/5.0in |
| 420-216 | 13.0cm/5.0in |



Recommended for 5/0 to 8/0 suture



Vascular (Delicate)

| Product No. | Description |
|-------------|----------------------------|
| 420-285 | 15.0cm/6.0in, Smooth Jaw |
| 420-286 | 15.0cm/6.0in, Serrated Jaw |
| 420-288 | 18.0cm/7.0in, Serrated Jaw |
| 420-290 | 20.0cm/8.0in, Serrated Jaw |



Recommended for 6/0 to 8/0 suture



Micro-Ryder

| Product No. | Description |
|-------------|---------------|
| 420-452 | 13.0cm/5.0in |
| 420-454 | 15.0cm/6.0in |
| 420-456 | 18.0cm/7.0in |
| 420-460 | 23.0cm/9.0in |
| 420-462 | 30.5cm/12.0in |



NEEDLE HOLDERS

Olsen-Hegar Needle Holders with Scissors

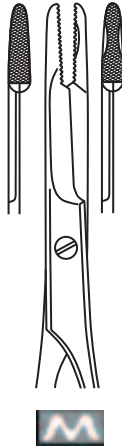

| Product No. | Description |
|-------------|-----------------------------|
| 080-510 | Smooth Jaw, 12.0cm/4.75in |
| 080-512 | Serrated Jaw, 12.0cm/4.75in |
| 080-514 | Serrated Jaw, 14.0cm/5.5in |
| 080-516 | Serrated Jaw, 16.0cm/6.25in |
| 080-518 | Serrated Jaw, 18.0cm/7.0in |



| Product No. | Description |
|-------------|-----------------------------|
| 420-912 | Serrated Jaw, 12.0cm/4.75in |
| 420-913 | Smooth Jaw, 12.0cm/4.75in |
| 420-914 | Serrated Jaw, 14.0cm/5.5in |
| 420-915 | Smooth Jaw, 14.0cm/5.5in |
| 420-917 | Serrated Jaw, 16.5cm/6.5in |
| 420-918 | Serrated Jaw, 18.0cm/7.0in |

Add **LH** for left-handed

Micro Needle Holders



Castroviejo Needle Holder

Flat handle, 14.0cm/5.5in

| Product No. | Description | Product No. | Description |
|-------------|--------------------|-------------|---------------------|
| 172-210 | Straight, w/o Lock | 172-217 | Straight, with lock |
| 172-215 | Straight w/ Lock | | 14.0cm/5.5in |
| 172-310 | Curved w/o Lock | | TC inserts |
| 172-315 | Curved w/ Lock | 172-317 | Curved, with lock |
| | | | 14.0cm/5.5in |
| | | | TC inserts |



Barraquer Micro Needle Holder

Round handles, 13.0cm/5.0in

| Product No. | Description |
|-------------|-----------------------|
| 172-329 | Straight Jaw w/o Lock |
| 172-330 | Curved Jaw w/o Lock |
| 172-331 | Straight Jaw w/ Lock |
| 172-333 | Curved Jaw w/ Lock |

Round handles, 18.0cm/7.0in

| Product No. | Description |
|-------------|-----------------------|
| 172-418 | Straight Jaw w/o Lock |
| 172-518 | Curved Jaw w/o Lock |
| 172-618 | Straight Jaw w/ Lock |
| 172-718 | Curved Jaw w/ Lock |



Breast Retractors & Dissectors

Retractors

Special Retractors

Tissue Wound Retractors

Self-Retaining Skin Retractors

Rake Retractors



RETRACTORS & SKIN & LOOKS

RETRACTORS & SKIN HOOKS - *Breast Retractors & Dissectors*



Biggs Mammoplasty Retractor

| | |
|-------------------|--|
| Product No. | Blade Size/Description |
| 110-667-30 | 30.0mm wide fenestrated blade, with fiberoptic light and suction |
| 110-667-50 | 50.0mm wide fenestrated blade, with fiberoptic light and suction |



Double-Ended Breast Retractor

31cm/12.25 in length

| | |
|-----------------|---------------------------------|
| Product No. | Blade Size |
| 110-653 | 37.0 x 70.0mm and 22.0 x 54.0mm |
| 110-653L | With Fiberoptic Light |

See page 8 for more



Product shown is Tebbetts Style Retractor with suction (**110-685S**)

Tebbetts Style

(with tooth serrated end)

| | |
|----------------|-----------------------------|
| Product No. | Blade Size (length x width) |
| 110-690 | 80mm x 16mm |
| 110-685 | 100mm x 25mm |
| 110-686 | 120mm x 25mm |
| 110-687 | 120mm x 30mm |
| 110-688 | 150mm x 25mm |
| 110-689 | 150mm x 30mm |

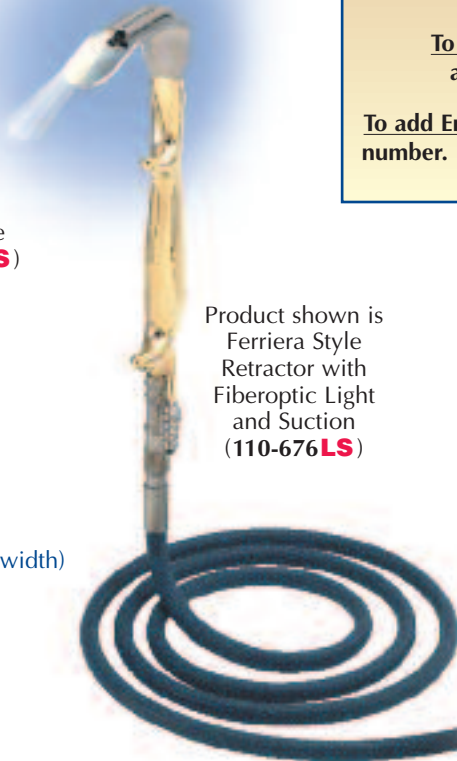

Product shown is Ferriera Style Retractor with Fiberoptic Light and Suction (**110-676LS**)

To add Fiberoptic Light, add L to the product number. To add Suction, add S to the product number.

To add Fiberoptic Light and Suction, add LS to the product number.

To add Endoscopic Sheath, add E to the product number. E requires 15cm length minimum blade and 15mm width minimum.

Ferriera Style

(with smooth end)

| | |
|----------------|-----------------------------|
| Product No. | Blade Size (length x width) |
| 110-672 | 80mm x 16mm |
| 110-675 | 100mm x 25mm |
| 110-676 | 120mm x 25mm |
| 110-677 | 120mm x 30mm |
| 110-678 | 150mm x 25mm |
| 110-679 | 150mm x 30mm |

Autoclavable Fiberoptic Cord

ACMI Light Source End with Storz™ Instrument End

| | |
|----------------|-------------------|
| Product No. | Length |
| 350-372 | 3 meters (10 ft.) |



Agris-Dingman Transauxillary Breast Dissector

| | |
|----------------|------------------|
| | Pair: Left/Right |
| Product No. | Description |
| 110-382 | 40.0cm/15.75in. |



MacCollum-Dingman Transauxillary Breast Dissector

| | |
|----------------|---------------|
| | Angled Shaft |
| Product No. | Description |
| 110-384 | 31.5cm/12.5in |



Reynolds Transauxillary Breast Dissector

| | |
|----------------|--|
| | Fenestrated |
| Product No. | Description |
| 110-380 | 40.0cm/15.75in |
| | Non-Fenestrated, for breasts and buttocks |
| Product No. | Description |
| 110-386 | 33cm/13in |



D-Bra

Easy to install. Can be used as a wrap and straps slip up after recovery. Latex free. Velcro® front. White only.

S; M; L; XL

Product No. **GADBra**

(See page 74 for more bra options)

RETRACTORS & SKIN HOOKS - Retractors



Aufricht Nasal Retractor

| Product No. | Blade Size |
|-------------|-----------------------------------|
| 200-252 | 7.0mm wide, 16.0cm/6.25in length |
| 200-250 | 10.0mm wide, 16.0cm/6.25in length |
| 200-252L | With Fiberoptic Light |
| 200-250L | With Fiberoptic Light |



Wieder

| Product No. | Blade Size |
|-------------|------------------------------|
| 110-669 | 28.0mm serrated |
| 110-670 | 36.0mm serrated |
| 110-669L | With Fiberoptic Light |
| 110-670L | With Fiberoptic Light |



Add NC
for non-conductive
coating

Farabeuf

Set of 2

| Product No. | Description |
|-------------|---------------|
| 110-121 | 12.0cm/4.75in |
| 110-125A | 15.0cm/6.0in |

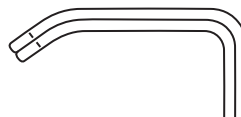

Add NC
for non-conductive
coating

U.S. Army (Parker-Langenbeck)

Set of 2

| Product No. | Description |
|-------------|--------------|
| 110-122 | 21.5cm/8.5in |

Ribbon

18cm/7in length

| Product No. | Width |
|-------------|---------------------------|
| 110-123 | 6.0mm /.25in (1/4in) |
| 110-124 | 10.0mm /.375in (3/8in) |
| 110-125 | 13.0mm /.5in (1/2in) |
| 110-126 | 15.0mm /.625in (5/8in) |
| 110-127 | 19.0mm /.75in (3/4in) |
| 110-129 | 25.0mm/1.0in |

33cm/13in. length

| | |
|---------|-------------|
| 110-130 | 19mm/.75in |
| 110-132 | 25mm/1.0in |
| 110-136 | 31mm/1.25in |
| 110-140 | 50mm/2.0in |
| 110-142 | 75mm/3.0in |

Add NC
for non-conductive
coating

To add Suction, add **S**
to the product number.
Add **NC** for non-conductive coating.



Deaver Retractor

with Fiberoptic Blade

| Product No. | Description |
|-------------|-----------------|
| 110-663 | 16.0mm x 9.0in |
| 110-664 | 25.0mm x 9.0in |
| 110-665 | 38.0mm x 13.0in |
| 110-666 | 25.0mm x 13.0in |

Without Fiberoptic Light

| | |
|---------|--------------------------|
| 110-200 | 25mm x 23cm/1.0in x 9in |
| 110-202 | 25mm x 30cm/1.0in x 12in |
| 110-206 | 38mm x 30cm/1.5in x 12in |
| 110-208 | 51mm x 30cm/2.0in x 12in |
| 110-219 | 19mm x 18cm/.75in x 7in |



Heaney/Simon Retractor

Fiberoptic Blade

| Product No. | Blade Size |
|-------------|---------------|
| 254-642 | 1.0in x 5.0in |



Lighted Freeman Flap Retractor

| | |
|----------|--------------------------|
| 110-320 | 12.0mm wide, 20cm/8.0in |
| 110-320A | Without fiberoptic light |

Marina Medical can customize any retractor. Please call your Account Manager for information regarding non-conductive coating, fiberoptics and sizing.

RETRACTORS & SKIN HOOKS - *Special Retractors*



Jaeger Lid Plate

11.0cm/4.25in

Product No.

110-046

110-046NC

110-046L

Description

Stainless

Non-conductive coating

Laser



Desmarres Lid Retractor

Length 14cm/5.5in

Stainless

Non-Conductive

Product No.

110-050

110-052

110-054

110-056

Description

10.0mm

12.0mm

14.0mm

16.0mm

Product No.

110-050NC

110-052NC

110-054NC

110-056NC

Insulated



Add **NC**
for non-
conductive
coating



Kasden Double-Ended Retractor

Product No.

110-084

Description

16.0cm/6.25in

Add **NC**
for non-
conductive
coating



Ragnell-Davis

Product No.

110-073

Description

15.0cm/6.0in

Add **NC**
for non-
conductive
coating



Senn-Mueller

Product No.

110-074

110-076

110-074NC

Description

3-Prong, Sharp

3-Prong, Blunt

Add **NC**
for non-
conductive
coating



110-058NC

Double-Ended Desmarres

Product No.

110-058

Description

15.0cm/6.0in

8/10mm blades

Tissue Wound Retractors

SELF-RETAINING SKIN RETRACTORS

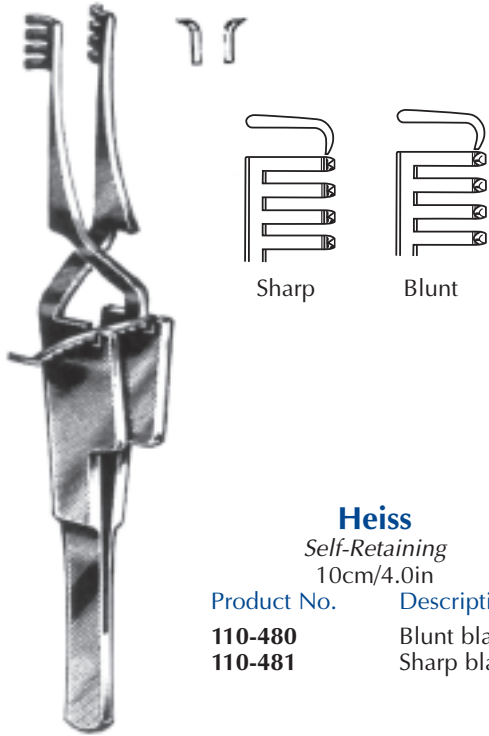

Heiss
Self-Retaining
10cm/4.0in

| Product No. | Description |
|-------------|--------------|
| 110-480 | Blunt blades |
| 110-481 | Sharp blades |



Alm
Self-Retaining
10cm/4.0in

| Product No. | Description |
|-------------|--------------|
| 110-483 | Blunt blades |
| 110-484 | Sharp blades |

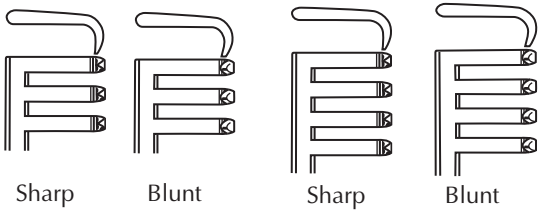

Weitlaner
2 x 3 Prongs
11.0cm/4.5in

| Product No. | Description |
|------------------------------|--------------|
| 110-509 | Sharp blades |
| 110-513 | Blunt blades |
| 3 x 4 Prongs 12.5cm/5.0in | |
| 110-609 | Sharp blades |
| 110-613 | Blunt blades |
| 3 x 4 Prongs 16.5cm/6.5in | |
| 110-614 | Sharp blades |
| 110-615 | Blunt blades |

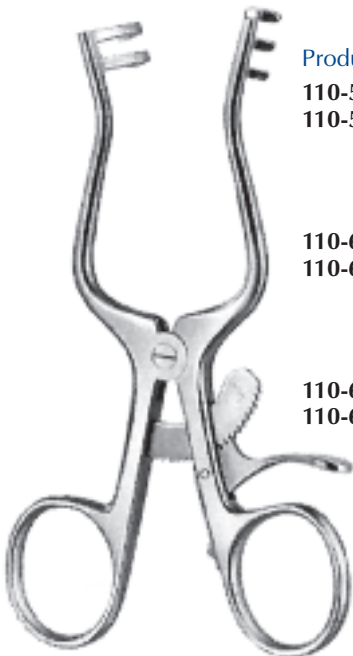

Gelpi

| Product No | Description |
|------------|--------------|
| 110-365 | 11.0cm/4.5in |
| 110-366 | 16.0cm/6.0in |
| 110-367 | 18.0cm/7.0in |



Bow Retractors

| Product No | Description |
|----------------------|-------------------|
| <i>without teeth</i> | |
| 190-390 | 1.125in/28mm wide |
| 190-391 | 1.25in/ 32mm wide |
| 190-392 | 1.375in/35mm wide |
| <i>with teeth</i> | |
| 190-393 | 1.125in/28mm wide |
| 190-394 | 1.25in/ 32mm wide |
| 190-395 | 1.375in/35mm wide |

RETRACTORS & SKIN HOOKS - *Skin Hooks & Retractors*



 Add **NC**
 for non-conductive
 coating

Fomon
 16.0cm/6.25in
 Product No.
190-163
 Description
 Single-Ended Ball

Product No.
190-167
 Description
 Double-Ended Ball



Frazier
 12.5cm/5.0in
 Product No.
190-168
 Description
 Dura Hook, Blunt

Product No.
190-169
 Description
 Dura Hook, Sharp



Tyrell (Iris)
 15.0cm/6.0in
 Product No.
190-170
 Description
 Single, Very Delicate,
 Round Handle



Graefe (Iris)
 12.5cm/5.0in
 Product No.
190-179
 Description
 Single, Very Delicate,
 Flat Handle

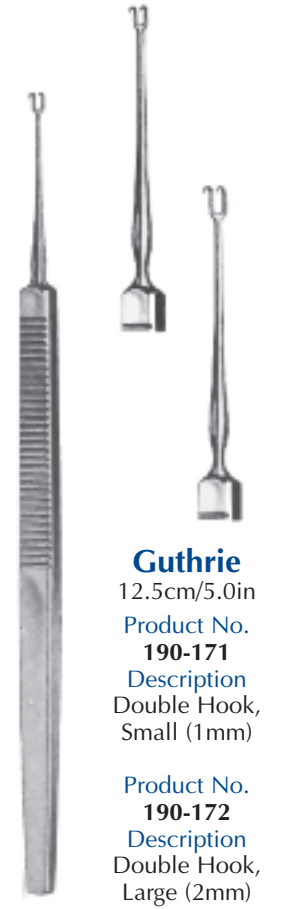

Guthrie
 12.5cm/5.0in
 Product No.
190-171
 Description
 Double Hook,
 Small (1mm)

Product No.
190-172
 Description
 Double Hook,
 Large (2mm)



Lahey
 12.0cm/4.75in
 Product No.
190-173
 Description
 Single Prong,
 Round Handle

Product No.
190-177
 Description
 Double Prong,
 Round Handle



Barsky
 16.0cm/6.25in
 Product No.
190-1832
 Description
 Nasal tenaculum,
 2 sharp prongs,
 9mm width



Rollet (Knapp)
 14.0cm/5.75in
 Product No.
190-174
 Description
 4-Prong, Sharp

Product No.
190-178
 Description
 4-Prong, Blunt



Kleinert-Kutz
16.0cm/6.5in
Product No.
190-176
Description
Single Prong

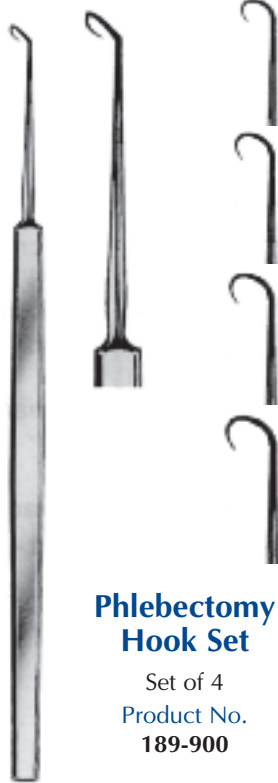

Phlebectomy Hook Set
Set of 4
Product No.
189-900



Add **NC**
for non-
conductive
coating

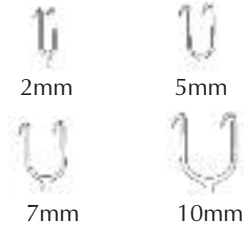

Joseph
15.0cm/6.0in
Product No. Description
190-180 Single Prong
190-181 Double Prong, 2.0mm width
190-182 Double Prong, 5.0mm width
190-183 Double Prong, 7.0mm width
190-1831 Double Prong, 10.0mm width



Cottle-Neivert Retractor/Needle Guide
21.0cm/8.25in
Product No.
190-165

Millard Double Thumb Hook (Kilner-Martinez)

10mm wide, length
8.5cm/3.5in
Product No.
190-219



Cottle Thumb Hook
Product No. Description
190-218 Double Prong, Sharp, 8.0mm w/ Adjustable Thumb Ring

Double Prong Thimble Hook

Product No. Description
190-217 Double prong, Sharp, 18.0mm



RETRACTORS & SKIN HOOKS - *Rake Retractors*



Gorney Rake Spring Neck
 4 sharp prongs
 Product No. **110-332**
 Description
 1.5in wide, 3.0in length

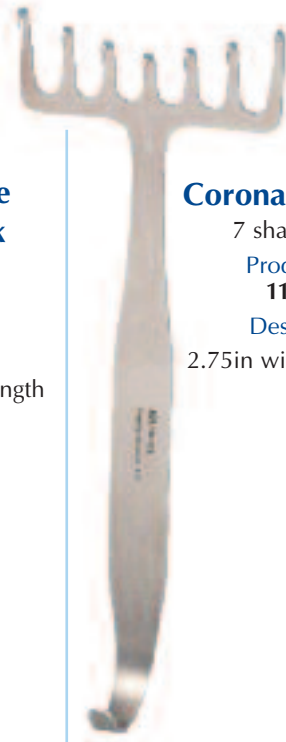

Coronal Brow Lift
 7 sharp prongs
 Product No. **110-338**
 Description
 2.75in wide, 7.0in long



Anderson Claw
 Product No. **110-342**
 Description
 3 prongs, 12.0cm/4.75in
 Product No. **110-344**
 Description
 5 prongs, 12.0cm/4.75in



Freeman Rake

| Product No. | Description |
|----------------|---|
| 110-333 | 4 Sharp Prongs, 1.5in width, 4.0in length |
| 110-334 | 4 Blunt Prongs, .75in width, 7.0in length |
| 110-335 | 4 Sharp Prongs, 1.5in width, 7.0in length |
| 110-336 | 4 Sharp Prongs, .875in width, 7.0in length |
| 110-337 | 4 Sharp Prongs, 1.0in width, 4.25in length |
| 110-340 | 4 Sharp Prongs, .75in width, 2.0in length with thumb ring |



Yancoskie Abdominoplasty Retractor

| Product No. | Description |
|----------------|--|
| 110-331 | 6 Sharp Prongs, 15.0cm/6.0in width, 18.0cm/7in. length |



Nasal Retractors
Periosteal Elevators
Otobraders
Mirrors
Ear Loops
Curettes
Rasps
Chisels & Osteotomes
Cartilage Crushers
Rongeurs & Bone Cutters
Rhinoplasty Sets
Alligator & Cupped Forceps

COAR, NOSE & THROAT

EAR, NOSE & THROAT - Nasal Series Specialty Retractors



Converse Alar Retractor

Double ended, sharp,
12.0cm/4.75in
Product No.
110-648



Add **NC** for non-conductive coating

Maliniac Nasal Retractor

11.0cm/4.25in

Product No. Blade Size
110-651 11.0mm x 44.0mm blade,
110-651L **With Fiberoptic Light**



Add **NC** for non-conductive coating

Converse Nasal Retractors

9.5cm/3.75in Length

| Product No. | Description |
|----------------|-------------------|
| 190-304 | 16mm x 10mm Blade |
| 190-305 | 30mm x 12mm Blade |
| 190-308 | 40mm x 13mm Blade |
| 190-309 | 55mm x 13mm Blade |

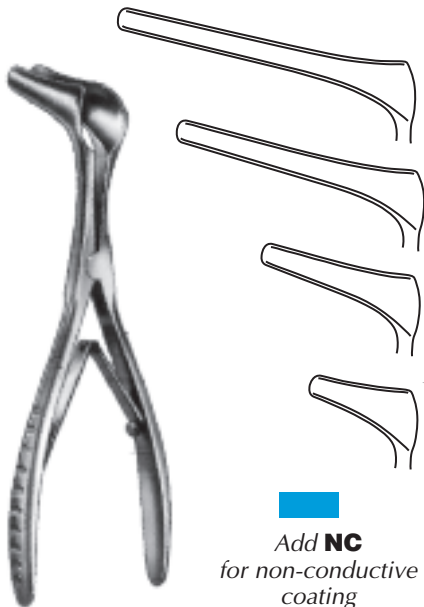

Add **NC** for non-conductive coating

Killian Nasal Speculum

Narrow Blades, Full Internal Groove
14.0cm/5.5in

| Product No. | Description |
|----------------|-------------|
| 190-293 | 40mm Blade |
| 190-294 | 55mm Blade |
| 190-295 | 75mm Blade |
| 190-296 | 90mm Blade |

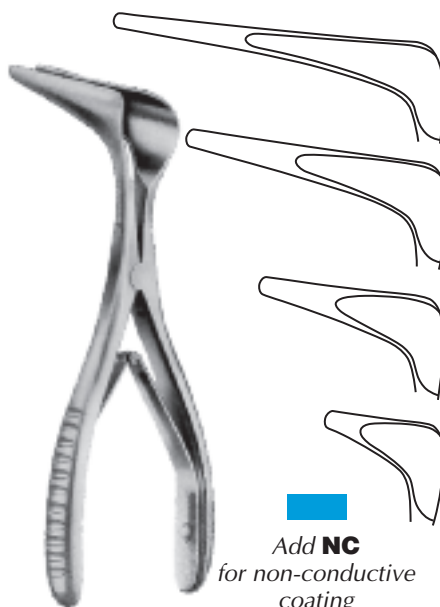

Add **NC** for non-conductive coating

Cottle Nasal Speculum

Narrow Blades, Partial Internal Groove
15.0cm/6.0in

| Product No. | Description |
|----------------|-------------|
| 190-310 | 35mm Blade |
| 190-311 | 50mm Blade |
| 190-312 | 75mm Blade |
| 190-306 | 90mm Blade |

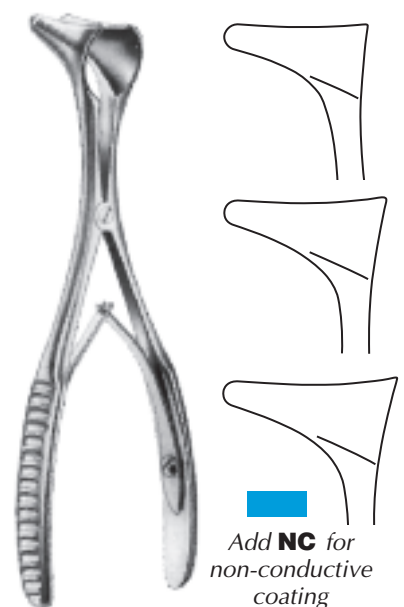

Add **NC** for non-conductive coating

Vienna Nasal Speculum

14.0cm/5.5in

| Product No. | Description |
|----------------|--------------------|
| 190-301 | Small Blade, 20mm |
| 190-302 | Medium Blade, 25mm |
| 190-303 | Large Blade, 30mm |

Periosteal Elevators



Joseph
 18.0cm/7.0in
 Product No. **190-248**
 Description
 Cottle Handle,
 Curved, 4.0mm wide blade

Freer
 18.0cm/7.0in
 Double-Ended
 Product No. **190-250**
 Description
 S/B, 5.0mm tip,
 Round handle

McKenty
 20.0cm/8.0in
 Product No. **190-253**
 Description
 Curved,
 3.0mm wide blade,
 Flat handle

Cottle Periosteal
 19.0cm/7.5in
 Product No. **190-254**
 Description
 Slightly curved,
 4.0mm tapered
 blade

Cottle Septum
 23.0cm/9.0in
 Product No. **190-255**
 Description
 Double-Ended,
 Graduated in Cm

Williger Elevator
 16cm/6.25in
 Product No. **190-249**
 Description
 4.0mm Sharp Blade,
 Slightly curved

Parkes Nasal
 15.0cm/6.0in
 Product No. **110-085**
 Description
 Strongly curved,
 6.0mm wide blade

EAR, NOSE AND THROAT

Billeau Ear Loops

Flexible, 16.5cm/6.5in



| Product No. | Description |
|----------------|-------------|
| 190-101 | Size #1 |
| 190-102 | Size #2 |
| 190-103 | Size #3 |

Buck Ear Curettes

16.5cm/6.5in



Sharp, Straight

Product No.

- 190-104-00**
- 190-104**
- 190-105**
- 190-106**
- 190-107**
- 190-108**
- 190-109**

Description

- #00, Sharp, Straight
- #0, Sharp, Straight
- #1, Sharp, Straight
- #2, Sharp, Straight
- #3, Sharp, Straight
- #4, Sharp, Straight
- #5, Sharp, Straight



Blunt, straight

Product No.

- 190-114A**
- 190-115**
- 190-116**
- 190-117**
- 190-118**

Description

- #0, Blunt, Straight
- #1, Blunt, Straight
- #2, Blunt, Straight
- #3, Blunt, Straight
- #4, Blunt, Straight



Sharp, Angled

Product No.

- 190-110**
- 190-111**
- 190-112**
- 190-113**
- 190-114**

Description

- #0, Sharp, Angled
- #1, Sharp, Angled
- #2, Sharp, Angled
- #3, Sharp, Angled
- #4, Sharp, Angled



Blunt, Angled

Product No.

- 190-1190**
- 190-1191**
- 190-1192**
- 190-1193**
- 190-1194**

Description

- #0, Blunt, Angled
- #1, Blunt, Angled
- #2, Blunt, Angled
- #3, Blunt, Angled
- #4, Blunt, Angled

Double-Ended Disposable Ear Curettes

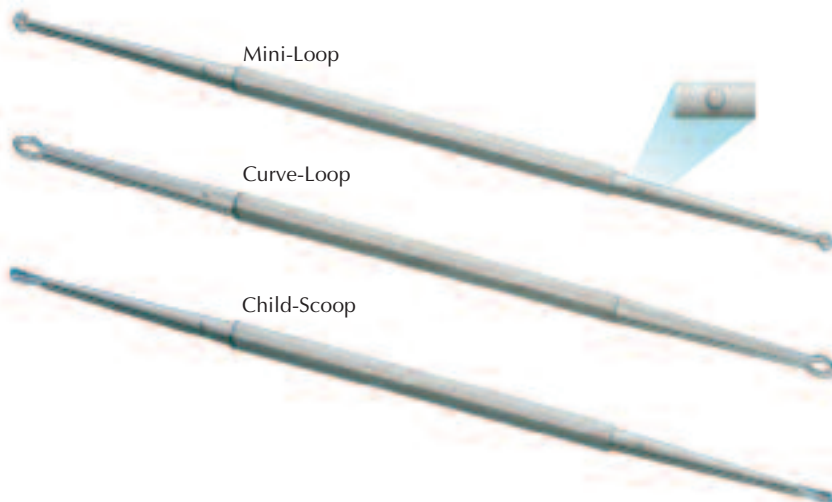

Mini-Loop

Curve-Loop

Child-Scoop

Product No.

- P103-8043**
- P103-8042**
- P103-8041**

Description

- Mini-Loop. For hardened wax
- Curve-Loop. For general procedures
- Child-Scoop. For smaller children and infants

50 per box



Laryngeal Mirrors with Handle



| Product No. | Description | Product No. | Description |
|-------------|-------------|-------------|-------------|
| 190-078 | #000 | 190-085 | #5 |
| 190-079 | #00 | 190-086 | #6 |
| 190-080 | #0 | 190-087 | #7 |
| 190-081 | #1 | 190-088 | #8 |
| 190-082 | #2 | 190-089 | #9 |
| 190-083 | #3 | 190-090 | #10 |
| 190-084 | #4 | | |

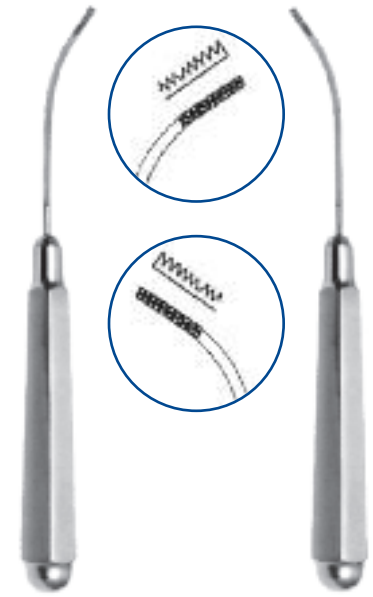

Dingman Otopraders

14.0cm/5.5in

| Product No. | Description |
|-------------|----------------------------------|
| 201-095 | Left and right pattern, set of 2 |

Glass Bead Mirror Warmer

- *Unsurpassed convenience in warming mirrors during laryngeal examinations*
- *Simply immerse the mirror into the hot beads for 3 to 5 seconds when needed*
- *Thermal wall remains cool and safe to touch*

| Product No. | Description |
|-------------|--------------------------------------|
| P1006131 | Mirror Warmer and Glass Beads (110V) |
| P1006132 | Mirror Warmer and Glass Beads (220V) |
| P1006105 | Replacement Beads |





EAR, NOSE AND THROAT - *Nasal Rasps*

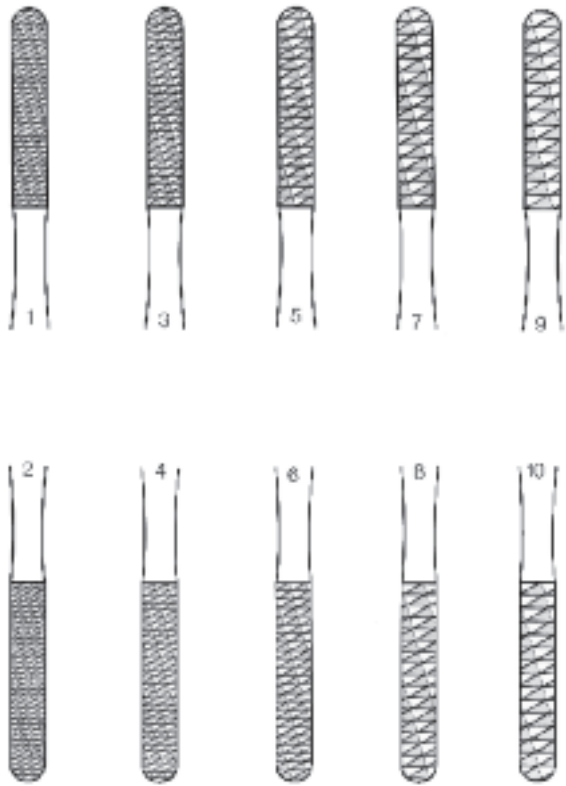

Fomon Nasal Rasps - Diamond Jaw

Double-Ended, Tungsten Carbide
20.0cm/8.0in

| Product No. | Description |
|-------------|--------------------|
| 200-201 | 1/2, Very Fine |
| 200-203 | 3/4, Medium Fine |
| 200-205 | 5/6, Medium |
| 200-207 | 7/8, Medium Coarse |
| 200-209 | 9/10, Very Coarse |

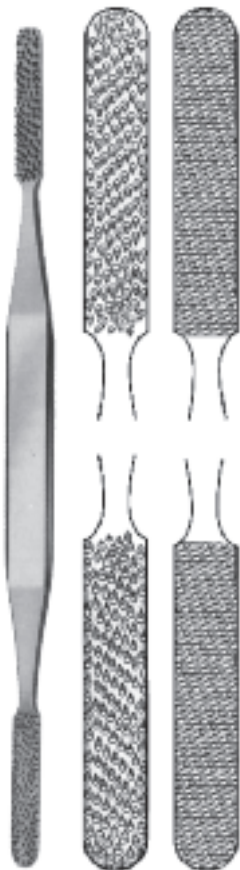

Fomon Nasal - 4-Sided

20.0cm/8.0in
Double-Ended
Product No. **200-215**
Description
Fine and coarse teeth in both flat and convex

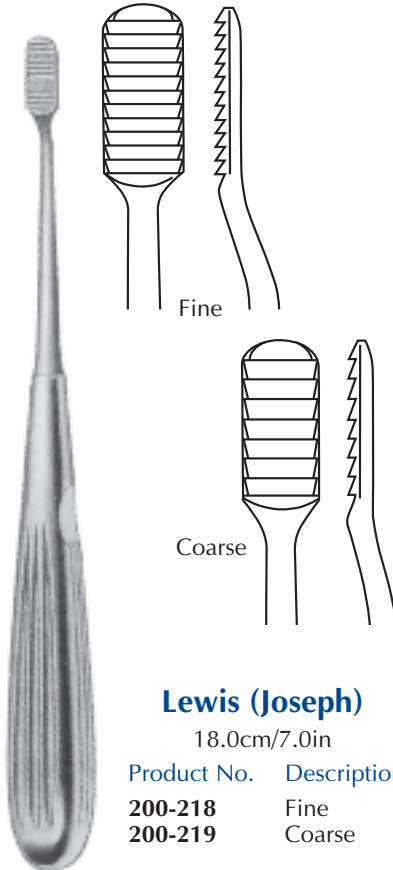

Lewis (Joseph)

18.0cm/7.0in
Product No. Description
200-218 Fine
200-219 Coarse



Joseph

16.0cm/6.25in
Product No. Description
200-220 Medium Serrations

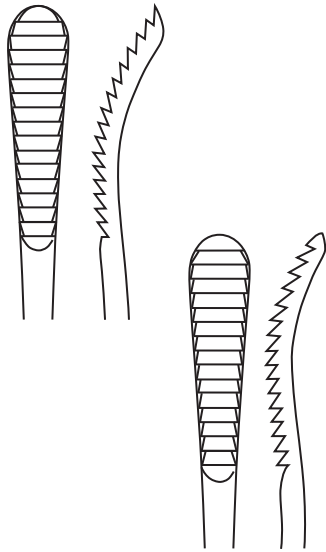

Aufricht Rasp

21.5cm/8.5in

| Product No. | Description |
|-------------|----------------------|
| 200-222 | Up Cutting, Curved |
| 200-223 | Down Cutting, Curved |

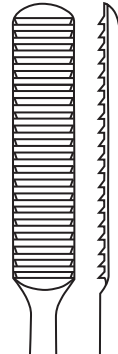

Cottle (Parkes)

21.0cm/8.5in

| Product No. | Description |
|-------------|--------------|
| 200-224 | Down Cutting |

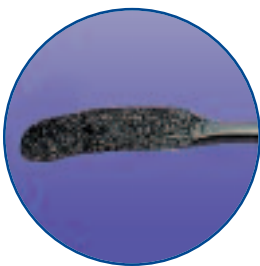

Peet Cottle Rasp

19cm/7.5in

| Product No. |
|-------------|
| 200-192 |



Description
Slightly Curved, Diamond Dust
Finishing Rasp

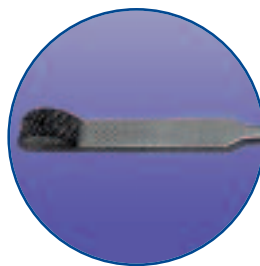

Glabellar Rasp

20.0cm/8.0in

| Product No. | Description |
|-------------|---------------------------------|
| 200-190 | Tungsten Carbide Button Rasp |

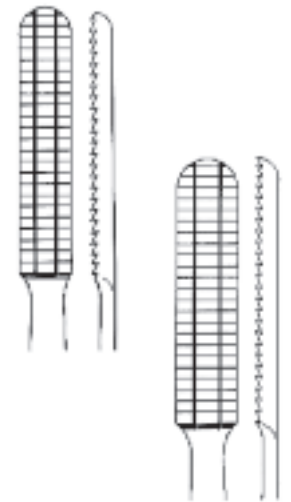

Maltz Rasp

18.0cm/7.0in

| Product No. | Description |
|-------------|--------------|
| 200-225 | Down Cutting |
| 200-226 | Up Cutting |



EAR, NOSE AND THROAT - *Chisels/Osteotomes*

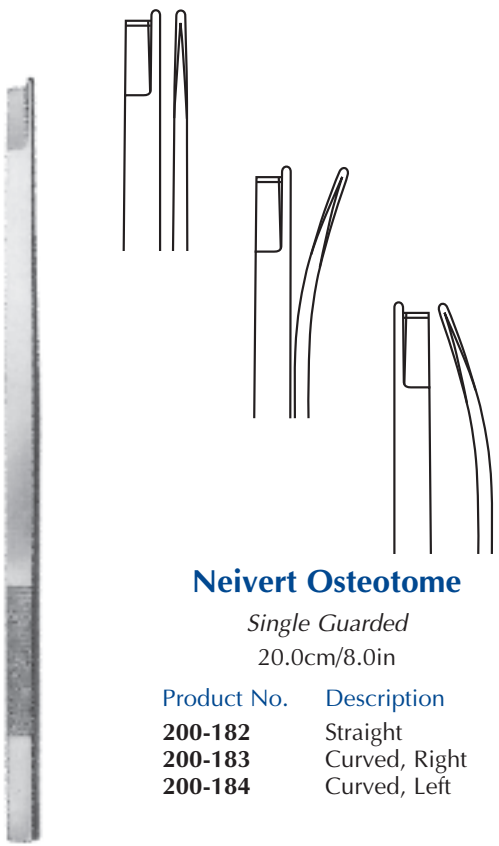

Neivert Osteotome

Single Guarded
20.0cm/8.0in

| Product No. | Description |
|-------------|---------------|
| 200-182 | Straight |
| 200-183 | Curved, Right |
| 200-184 | Curved, Left |



Ballenger Swivel Knife

19.5cm/7.75in

| Product No. | Description | |
|-------------|---------------|----------|
| | Bayonet Style | Straight |
| 190-313 | 3.0mm | 190-317 |
| 190-314 | 4.0mm | 190-318 |
| 190-315 | 5.0mm | 190-319 |
| 190-316 | 6.0mm | 190-3196 |

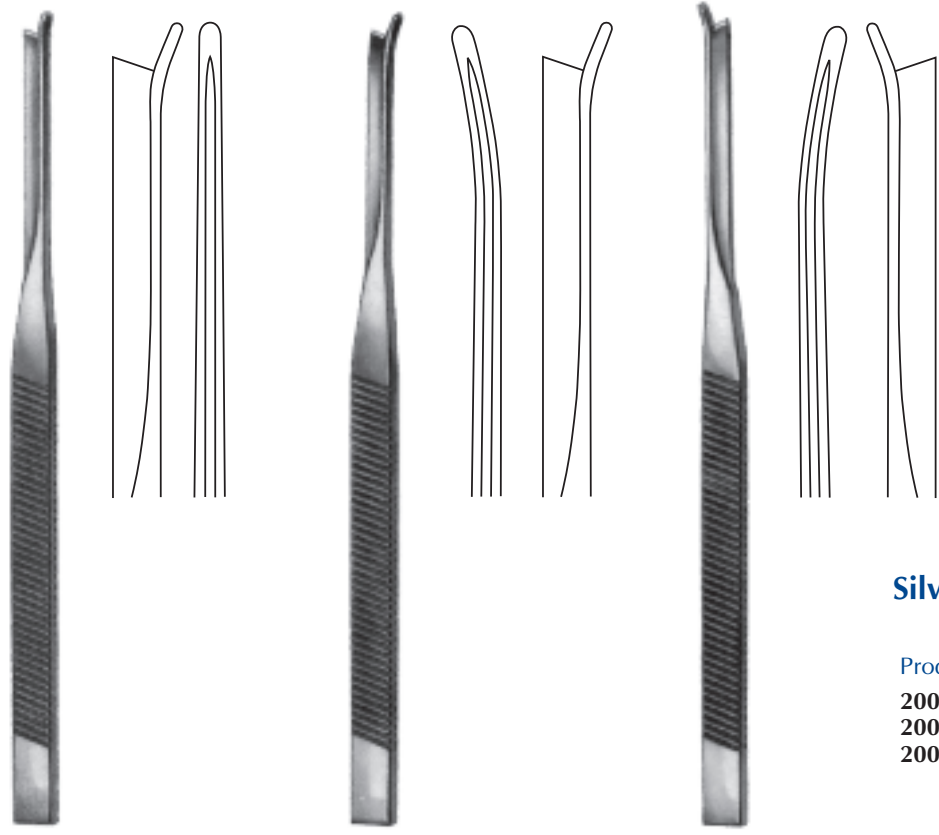

Silver Nasal Osteotome

18.0cm/7.0in

| Product No. | Description |
|-------------|---------------|
| 200-600 | Straight |
| 200-601 | Curved, Right |
| 200-602 | Curved, Left |



Cottle Osteotome

18.0cm/7.0in

| Product No. | Description |
|-------------|-------------|
| 200-165 | 2.0mm |
| 200-166 | 4.0mm |
| 200-167 | 6.0mm |
| 200-168 | 8.0mm |
| 200-169 | 10.0mm |

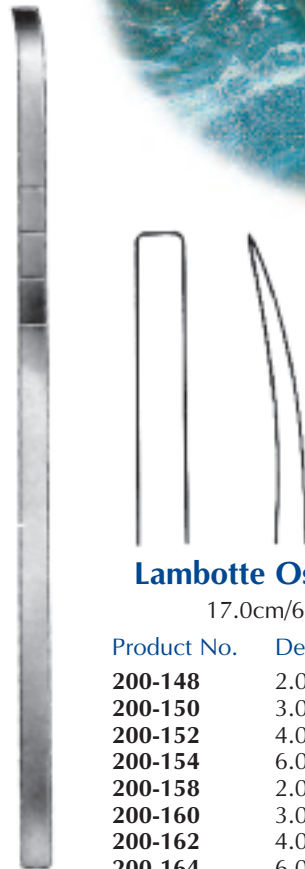

Lambotte Osteotome

17.0cm/6.75in

| Product No. | Description |
|-------------|-----------------|
| 200-148 | 2.0mm, straight |
| 200-150 | 3.0mm, straight |
| 200-152 | 4.0mm, straight |
| 200-154 | 6.0mm, straight |
| 200-158 | 2.0mm, curved |
| 200-160 | 3.0mm, curved |
| 200-162 | 4.0mm, curved |
| 200-164 | 6.0mm, curved |



Cinelli Osteotome

Double Guarded
16.0cm/6.25in

| Product No. | Description |
|-------------|-------------|
| 200-110 | 10.0mm |
| 200-112 | 12.0mm |
| 200-114 | 14.0mm |
| 200-116 | 16.0mm |

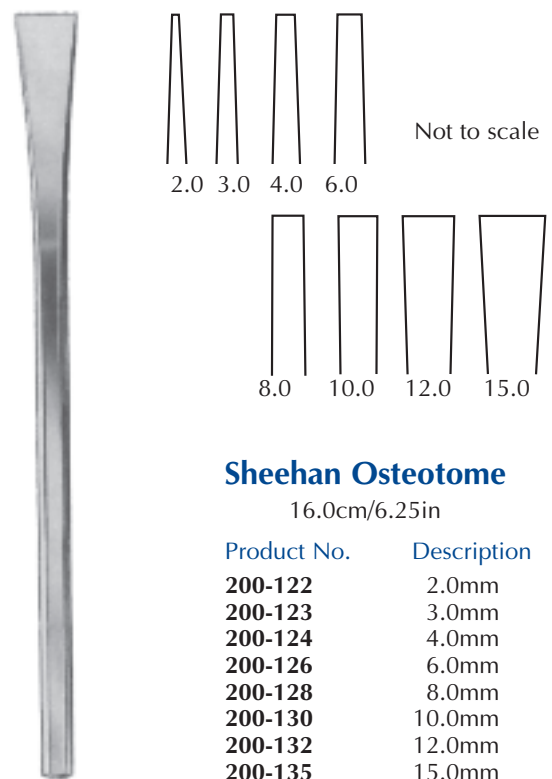

Sheehan Osteotome

16.0cm/6.25in

| Product No. | Description |
|-------------|-------------|
| 200-122 | 2.0mm |
| 200-123 | 3.0mm |
| 200-124 | 4.0mm |
| 200-126 | 6.0mm |
| 200-128 | 8.0mm |
| 200-130 | 10.0mm |
| 200-132 | 12.0mm |
| 200-135 | 15.0mm |



EAR, NOSE AND THROAT - *Mallets*



Marina

18.0cm/7.0in

Product No. **201-250**
Description
250 grams, 1.0in OD
Interchangeable Nylon Caps



Mead

18.5cm/7.25in

Product No. **201-252**
Description
230 grams, Interchangeable
Plastic Discs



Lucae

18.0cm/7.0in

Product No. **201-254**
Description
265 grams, 1.0in O.D.



Marina Delicate

18.0cm/7.0in

Product No. **201-251**
Description
218 grams, .75in O.D.
Interchangeable Nylon Caps



Baby Gerzog

16.5cm/6.5in

Product No. **201-256**
Description
172 grams, .75in O.D.



Marina Nylon/Steel

18.0cm/7.0in

Product No. **201-253**
Description
265 grams, 1.0in O.D.
One Face Steel,
One Face Plastic



Cartilage Crushers, Morselizers & Clamps



Cartilage Crushing Box

| Product No. | Description |
|-------------|-------------------------|
| 190-560 | Rectangular, smooth bed |



Tolsdorf Cartilage Crusher

| Product No. | Description |
|-------------|---------------------|
| 190-562 | Round, serrated bed |



Cottle Columella Clamp

| Product No. | Description |
|-------------|--------------|
| 190-340 | 10.0cm/4.0in |

Rubin Rhinoplasty Set



Rubin Rimometer

| Product No. | Description |
|-------------|-------------------------------|
| 289-258 | Alar Crimper, 11.0cm/4.5in |



Rubin Alar Morselizer
Tungsten Carbide Jaws

| Product No. | Description |
|-------------|---------------|
| 289-260 | 21.0cm/8.25in |



Septal Morselizer

Tungsten Carbide Jaws with Guard

| Product No. | Description |
|-------------|---------------|
| 289-261 | 21.0cm/8.25in |

EAR, NOSE AND THROAT - *Rubin Rhinoplasty Set*



Rubin Strut Forceps

| | |
|----------------|--------------|
| Product No. | Description |
| 289-262 | 18.0cm/7.0in |



Rubin Nasal Frontal Osteotome

| | |
|----------------|--|
| Product No. | Description |
| 289-264 | U-Shaped - for lateral use near the Glabella |



Rubin Nasal Lateral Osteotome

| | |
|----------------|--|
| Product No. | Description |
| 289-266 | U-Shaped with sharp knife to narrow Dorsal width |



Rubin Dorsal Osteotome

18.0cm/7.0in

| | |
|----------------|-------------|
| Product No. | Description |
| 289-246 | 8.0mm |
| 289-247 | 10.0mm |
| 289-248 | 11.0mm |
| 289-250 | 12.0mm |
| 289-251 | 14.0mm |
| 289-252 | 16.0mm |



Rubin Nasal Rasp

| | |
|----------------|----------------------|
| Product No. | Description |
| 289-254 | 30% oblique, concave |
| | 20.0cm/8.0in |



Rubin Nasal Frontal Rasp

| | |
|----------------|----------------------|
| Product No. | Description |
| 289-256 | Glabella button rasp |
| | 19.0cm/7.25in |

Rongeurs & Bone Cutters



Mini-Friedman

| | |
|----------------|--------------|
| Product No. | Description |
| 200-312 | 12.0cm/5.0in |



Friedman

| | |
|----------------|--------------|
| Product No. | Description |
| 200-314 | 14.0cm/5.5in |



Cleveland

| | |
|----------------|--------------|
| Product No. | Description |
| 200-316 | 14.0cm/5.5in |



Ruskin

Double Action

| | |
|----------------|----------------------|
| Product No. | Description |
| 200-324 | Curved, 18.0cm/7.0in |



Lempert

| | |
|----------------|------------------------|
| Product No. | Description |
| 200-310 | Straight, 18.0cm/7.0in |
| 200-311 | Curved, 18.0cm/7.0in |



Beyer

Double Action

| | |
|----------------|----------------------|
| Product No. | Description |
| 200-320 | Curved, 18.0cm/7.0in |



Liston

| | |
|----------------|-------------------------|
| Product No. | Description |
| 200-410 | Straight, 14.0cm/5.5in |
| 200-411 | Straight, 17.0cm/6.75in |
| 200-420 | Curved, 14.0cm/5.5in |
| 200-421 | Curved, 17.0cm/6.75in |

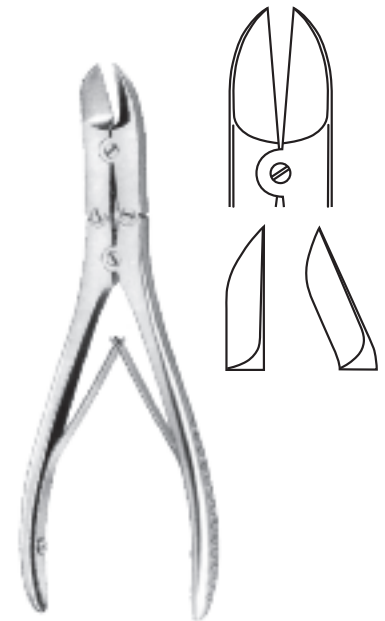

Ruskin-Liston

Double Action

| | |
|----------------|-------------------------|
| Product No. | Description |
| 200-430 | Straight, 15.0cm/6.0in |
| 200-431 | Curved, 15.0cm/6.0in |
| 200-440 | Straight, 18.0cm/7.25in |
| 200-441 | Curved, 18.0cm/7.25in |

EAR, NOSE AND THROAT - *Truswell Trocar & Alligator/Cupped Forceps*



Hartmann Alligator Forceps

| Product No. | Description |
|-------------|------------------------|
| 190-324 | 8.5cm/3.5in, Micro Jaw |
| 190-320 | 14.0cm/5.5in |
| 190-322 | 17.0cm/6.75in |
| 190-330 | 8.5cm/3.5in |

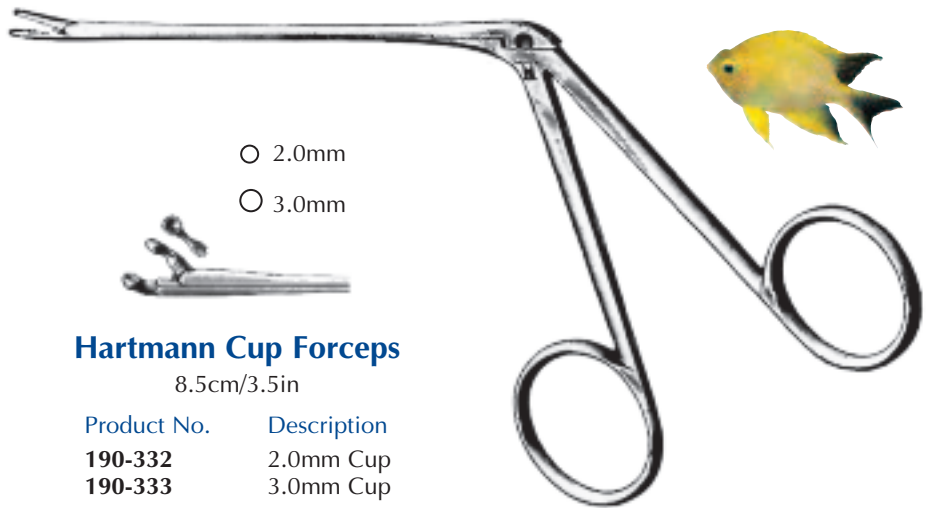

Hartmann Cup Forceps

8.5cm/3.5in

| Product No. | Description |
|-------------|-------------|
| 190-332 | 2.0mm Cup |
| 190-333 | 3.0mm Cup |

Noyes Nasal Forceps

| Product No. | Description |
|-------------|---------------------------|
| 190-328 | 1 x 2 Teeth, 14.5cm/5.5in |

Truswell Implant Insertion Trocar



| Product No. | Description |
|-------------|--|
| 190-327-1 | With Trocar triangle shape: 5.0mm x 95.0mm |
| 190-327-2 | With Trocar triangle and conical shape: 5.0mm x 95.0mm |

This 5mm Trocar and Sheath has been custom designed to ease the passage of facial implants. The instrument with removable trocar is introduced through a 3.0mm incision at one end of the implant site. The triangulated trocar tunnels to an incision at the exit point of the implant site. A release button allows the removal of the trocar, leaving an empty sheath. An alligator grasper is introduced into the distal end of the sheath. The entire insertion instrument is removed, leaving the grasping forceps in position to accept the implant to be pulled through the newly created tunnel. Created by Dr. William Truswell.

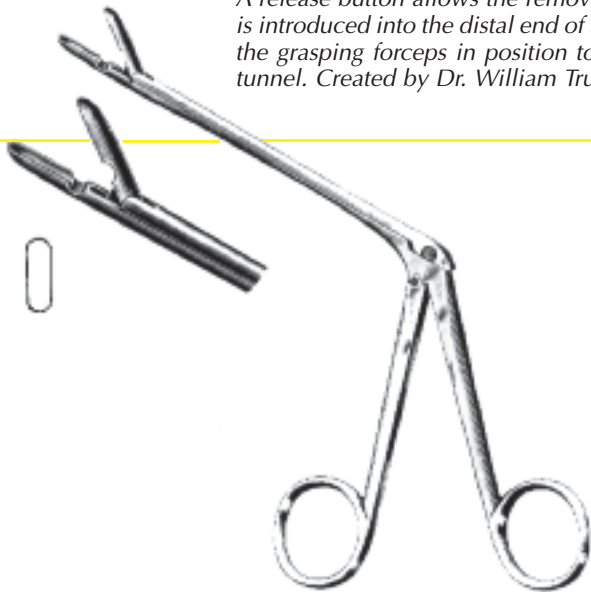

Takahashi

19.0cm/7.5in

| Product No. | Description |
|-------------|-------------------------|
| 200-572 | 4 x 10mm Jaws, Straight |



Carroll Tendon

11.0cm/4.5in

| Product No. | Description |
|-------------|--|
| 190-326 | Down Curved, used to pull lip prostheses |



DERMATOLOGY

Biopsy Punches
Dermal Currettes
Extractors
Nail Nippers
Scalpel Handles

DERMATOLOGY - *Biopsy Punches & Bowls*



Sterile, Disposable, Biopsy Punch

Seamless, Sharp

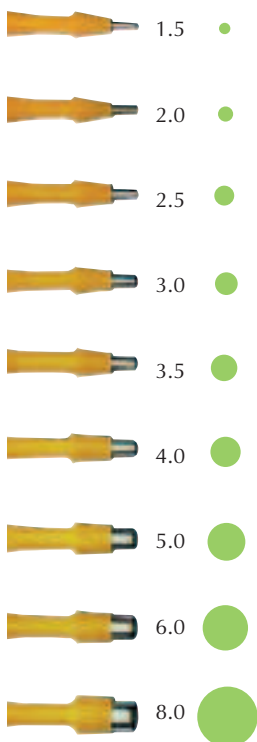

Available in all sizes, box of 25

Product No. Punch Size

| | |
|----------------|-------|
| 034-015 | 1.5mm |
| 034-020 | 2.0mm |
| 034-025 | 2.5mm |
| 034-030 | 3.0mm |
| 034-035 | 3.5mm |
| 034-040 | 4.0mm |
| 034-050 | 5.0mm |
| 034-060 | 6.0mm |
| 034-080 | 8.0mm |

Actual Sizes

Keys Reusable

Stainless Steel Biopsy Punch

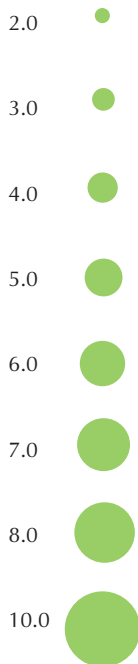

Product No.

Punch Size

| | |
|----------------|--------|
| 033-012 | 2.0mm |
| 033-013 | 3.0mm |
| 033-014 | 4.0mm |
| 033-015 | 5.0mm |
| 033-016 | 6.0mm |
| 033-017 | 7.0mm |
| 033-018 | 8.0mm |
| 033-020 | 10.0mm |

Actual Sizes

Keys Dermal Biopsy Punch Set

Product No. **033-010B**

- 2mm to 8mm Punches
- 2 Handles... Can telescope into each other
- Specimen Retriever
- Aluminum block, well organized
- Totally autoclavable
- Very cost effective



Emesis Basin

Stainless Steel

| Product No. | Description |
|----------------|--------------------|
| 020-060 | 6.0 x 3.5 x 1.75in |
| 020-061 | 8.0 x 3.6 x 1.75in |
| 020-065 | 10.0 x 4.5 x 2.0in |

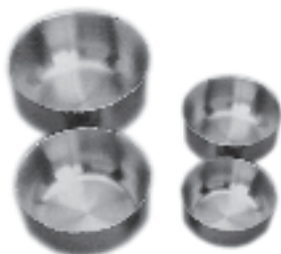

Sponge Bowl

Stainless Steel

| Product No. | Description |
|----------------|--------------|
| 020-070 | 5.75 x 2.5in |
| 020-071 | 4.5 x 2.0in |
| 020-072 | 6.5 x 3.0in |
| 020-073 | 7.5 x 3.0in |



Iodine Cup

Stainless Steel

| Product No. | Description |
|----------------|-------------|
| 020-080 | 6oz |
| 020-081 | 14oz |



Medicine Cup

Stainless Steel

| Product No. | Description |
|----------------|----------------|
| 020-085 | Graduated, 2oz |

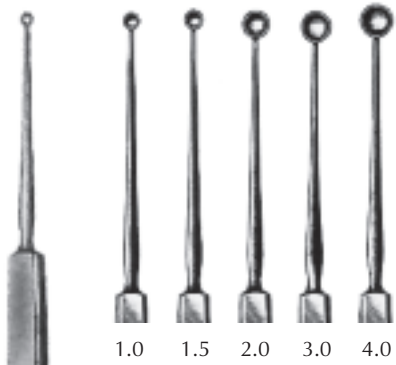

Meyhoefer
12.5cm/5.0in, Round, Sharp Edge
Closed Curette

| Product No. | Description |
|-------------|-------------|
| 190-184 | 1.0mm |
| 190-185 | 1.5mm |
| 190-186 | 2.0mm |
| 190-187 | 3.0mm |
| 190-188 | 4.0mm |

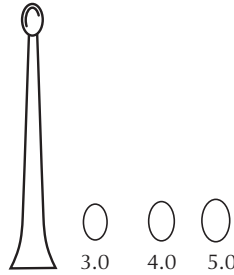

Marina Dermal
16.0cm/6.25in, Sharp
Oval Spoon, Closed

| Product No. | Description |
|-------------|-----------------|
| 190-190 | #0 - 3.0mm O.D. |
| 190-191 | #1 - 4.0mm O.D. |
| 190-192 | #2 - 5.0mm O.D. |



Fox
14.0cm/5.5in
Oval Tip

| Product No. | Description |
|-------------|-------------|
| 190-201O | 1.0mm |
| 190-202O | 2.0mm |
| 190-203O | 3.0mm |
| 190-204O | 4.0mm |
| 190-205O | 5.0mm |
| 190-206O | 6.0mm |

| Product No. | Description |
|-------------|-------------|
| 190-201R | 1.0mm |
| 190-202R | 2.0mm |
| 190-203R | 3.0mm |
| 190-204R | 4.0mm |
| 190-205R | 5.0mm |
| 190-206R | 6.0mm |



Frazier Dura Separator
Product No. 190-220
Description
17.0cm/6.75in



2.0mm



4.0mm



6.0mm

Single Use Curette Blades

The convenience of a disposable curette with the strength of a reusable curette.

- No need to re-sharpening
- No cleaning required
- Use with any #3 blade handle
- Most popular sizes available

| Product No. | Description |
|-------------|-------------|
| C32 | 2.0mm |
| C34 | 4.0mm |
| C36 | 6.0mm |



10 blades per box

DERMATOLOGY - Extractors

COMEDONE EXTRACTORS



Schamberg

| Product No. | Description |
|-------------|-----------------------|
| 190-140 | Extra fine with Crimp |
| 190-150 | Delicate with Crimp |
| 190-151 | Medium with Crimp |
| 190-152 | Heavy with Crimp |
| 190-154 | Delicate w/o Crimp |



Unna

| Product No. | Description |
|-------------|--|
| | Double-Ended |
| 190-156 | Double-Ended Oval, 14.5cm/5.75in |
| 190-155 | Double-Ended Round hole, 12.0cm/4.75in |



Saalfield

| Product No. | Description |
|-------------|------------------------------|
| | Round Extractor with Spear |
| 190-158 | Spear w/ Oval, 11.0cm/4.25in |
| 190-159 | Spear w/ Oval, 14.5cm/5.75in |
| 190-160 | Spear w/ Round, 10.0cm/4.0in |

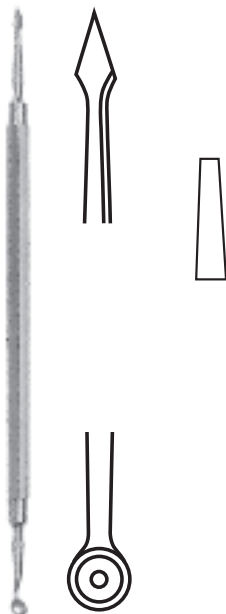

Walton (Katsch)

Round Extractor with Spear
16.0cm/6.25in

| Product No. | Description |
|-------------|---|
| 190-157 | Double-Ended with Spear Cap and Round Expressor |



Shalita Expressor

Round extractor with slot

16.0cm/6.25in

Product No.

190-611

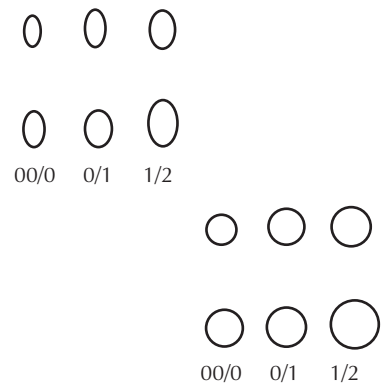

Marina Spoon

13.5cm/5.25in, Double-Ended, Sharp
Oval Tip

| Product No. | Description |
|-------------|-------------|
| 190-2130 | 00/0 |
| 190-2140 | 0/1 |
| 190-2150 | 1/2 |

Round Tip

| Product No. | Description |
|-------------|-------------|
| 190-213R | 00/0 |
| 190-214R | 0/1 |
| 190-215R | 1/2 |



Double Spring
Long, Narrow, Straight
 Jaws
 Product No. **190-500**
 Description 11.0cm/4.25in
 Product No. **190-501**
 Description 15.0cm/6.0in



Turnbull Barrel Spring
Curved Jaws
 Product No. **190-502**
 Description 12.0cm/4.75in
 Product No. **190-503**
 Description 14.0cm/5.5in



English Anvil Nail Splitter
 Straight Jaws
 Product No. **190-505**
 Description 13.0cm/5.25in



Heavy Pattern w/ Lock
 Curved Jaws
 Product No. **190-506**
 Description 14.5cm/5.75in

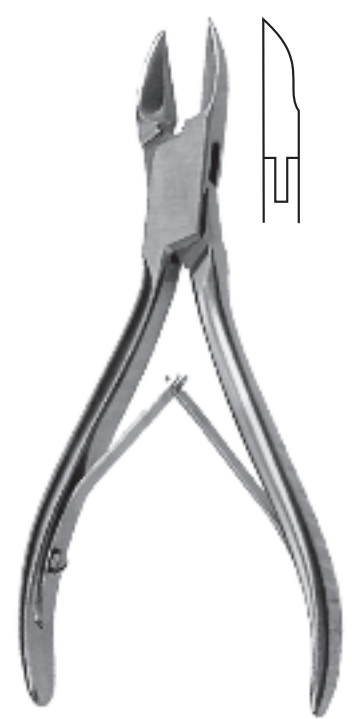

Double Spring
 Straight Jaws
 Product No. **190-507** Description 13.0cm/5.0in
 Product No. **190-510** Description 10.0cm/4.0in

DERMATOLOGY - Scalpel Handles



040-070



040-080



040-070L



040-070R



040-060



040-070RO



040-090



040-098

#3 Handle Graduated

040-070
For blades #10-18
12.5cm/5.0in

#4 Handle

040-080
For blades #20-25
13.5cm/5.25in

#3 Handle Long

040-070L
For blades #10-18
20.0cm/8.0in

#3 Handle Round

040-070R
For blades #10-18
14.5cm/5.75in

#3 Handle Round, Graduated

040-060
For blades #10-18
14.5cm/5.75in

#3 Handle Round, Oblique

040-070RO
For blades #10-18
14.5cm/5.75in

#7 Handle

040-090
For blades #10-18, 16.0cm/6.25in

Beaver Blade Handle

040-098
12.5cm/5.0in
040-099
15.0cm/6.0in

Sterile, Disposable Safety Scalpels



Blade size #10 **040-110D**



Blade size #11 **040-111D**



Blade size #15 **040-115D**

Pre-assembled stainless steel blades on plastic handles packaged sterile in peel-apart packaging. Available in boxes of 10

Sterile Disposable Scalpel Blades

Sterile, Disposable



#10 Scalpel
040-110
Box of 100

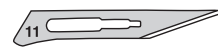

#11 Scalpel
040-111
Box of 100



#15 Scalpel
040-115
Box of 100

Scalpel Blade Removers

The secure and confident way to remove blades



15.0cm/6.0in
Product No.
040-101



5.0cm/2.0in
Product No.
040-100











Cannulas
Tubing
Aspirators
Infusion Pumps
Binders
Facial Supports
Bras

LIPOSUCTION & GARMENTS

LIPOSUCTION & GARMENTS - *Cannulas & Tubing*

Cannulas

Each cannula is manufactured from the finest quality stainless steel. Each cannula is precisely machined, polished and assembled to your own specifications. Choose from the most popular styles below, or create your own custom cannulas. Each cannula carries a lifetime warranty against defect.

| | |
|--|---|
|  | 20-1205-00 3 Port Radial (Mercedes) |
|  | 20-1207-00 Triport |
|  | 20-1206-00 Pyramid |
|  | 20-1201-00 2 Hole Standard |
|  | 20-1200-00 1 Hole Standard |
|  | 20-1240-00 Cane |
|  | 20-1211-00 Cobra K + |
|  | 20-1222-00 Spatula |





Infusion Cannulas

| | |
|--|--|
|  | 20-1218-00 Multi Hole Infusion |
|  | 20-1257-00 Open Ended |

All infusion tips come with deluxe luer lock tip base.

Micro Cannulas

All Micro Cannulas are mounted on deluxe luer lock hubs to withstand lateral stress. The distal ends of all cannulas have been filled to eliminate dead space. Micro Cannulas are available in a wide range of lengths, diameters and curves.

| | |
|--|---|
|  | 20-1515-00 Infiltration |
|  | 20-1501-00 Aspiration Harvesting |
|  | 20-1503-00 Side Port Re-injection |
|  | 20-1504-00 Re-injection Style II |
|  | 20-1507-00 V-Dissection |

One-Piece Cannula Handles

Choose the appropriate handle to accompany your cannula



Champagne
Ergonomic



1" Aluminum handle

Two-piece Cannula Handles



1" Delrin plastic



Two-Piece Cannula Base
Detaches from handle
7/8" Tip Base

Luer Lock Handles

Delrin Infusion Aspiration handle



Aluminum Luer Lock



On/Off Infusion Handle
Aluminum, with stop-cock



Trumpet Valve
On/Off Infusion valve

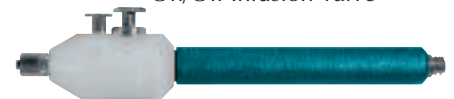

Select from 52 tips styles, 4 tip shapes, 12 standard lengths, 14 standard diameters, 5 basic curve options, 22 handles. Choose vent holes or not, or simply create your own custom cannula. Call your **Marina Medical** Account Manager for

Aspirators, Infusion & Tubing



Hercules™ Aspirator

Product No. 20-5007-00

Three high-powered, dual-cylinder piston pumps make this aspirator the most powerful on the market. Quiet and with a dent and scratch resistant casing. 5-year warranty on parts and labor.



Infusion Pump

Product No. 20-6000-00

Variable flow rate from 0-850 ml/min. System includes:

- 2 Infusion Needles
- 2 aluminum leuc lock handles
- 3 Spinal Needles
- Infusion Tubing (case of 5)
- Pneumatic foot switch
- Custom IV stand



V-Pal Sub Sonic Surgical System

Product No. 40-1001-00

The V-Pal utilizes a vibratory concentric motion that allows surgical instruments to pass effortlessly through soft tissue. Designed to fit the surgeon's hand, V-Pal combines a low vibration motor with a vibratory handpiece. An insulated sleeve is not required since overheating is never a problem. The V-Pal, using an offset mass cannula design, causes the surgical instrument to move in a 3mm concentric motion. This motion is profoundly different than the simple forward/backward motion found in reciprocating systems. This system randomly spreads cannula energy, reducing the battering-ram motion of reciprocating systems.

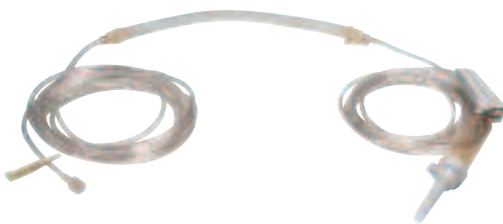

Infiltration Tubing

| Product No. | Description |
|-------------|--------------------------|
| 24-6001-00 | 188" length (Case of 10) |

Ready to use. No assembly required.
Single spike with silicon sleeve.



Aspiration Tubing

(Case of 10)

Baxter™

| Product No. | Description |
|-------------|-------------|
| 24-5103-00 | 9 ft limp |
| 24-5102-02 | 12 ft. flex |
| 24-5105-00 | 14 ft limp |

Sorenson™/Quick-Fit™

| Product No. | Description |
|-------------|-------------|
| 24-5104-00 | 9 ft limp |
| 24-5102-01 | 12 ft. flex |
| 24-5106-00 | 14 ft limp |

LIPOSUCTION & GARMENTS - *Garments for Liposuction* PLASTIC AND THORACIC

Hand made from the highest quality fabrics.



Liposuction Sleeve

Hook and eye adjustable closure. Must supply arm measurements for accurate size.

Product No. **GA-502**

Liposuction Slip-on Sleeve

Can be used with style 502.

Product No. **GA503**



Men's One-Piece Body Control

Features non-slip shoulder straps and a snap-crotch fly front. Constructed of nylon and spandex.

Sizes: S, M, L, XL, XXL

Product No. **GA302**



Men's Vest

Features adjustable Velcro® shoulder straps and front zipper closing. Made of soft cotton Lycra® spandex material.

An E. Marie Design.

Sizes: S, M, L, XL, XXL

Product No. **GA959**

Where applicable, add **S** for Small, **M** for Medium, **L** for Large, **XL** for Extra Large, and **XXL** for Double-Extra Large

Facial Support Binders



Otoplasty Band

Ear and face support. Men's and Ladies.
One size fits all.

Product No. **GA007**



Chin and Neck Support

Seamless. Men's and Ladies.
Sizes: M; L.

Product No. **GA203M**
GA203L



Chin and Neck Band

Soft nylon Lycra® spandex material.
Men's and Ladies.

Product No. **GA202**



Breast Binder

Ladies "Touch & Stay". Continuous adjustable (22" to 44") control. Strong Velcro® adjustment. Width is 3". Made of strong elastic material. One adjustable size.

Product No. **GA1750**



Men's or Ladies' Touch-and-Stay® Binder

Features continuous adjustable (22" to 44" or 30" to 50") control. Please specify waist size at time of ordering. Strong Velcro® adjustment.

Sizes: 6", 9", 12" width.

| Product No. | Description |
|----------------|-----------------|
| GA802SM | S/M (22" - 44") |
| GA802ML | M/L (30" - 50") |

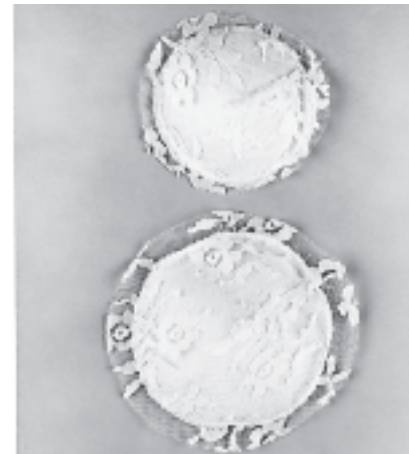

Breast Enhancers

A hidden beauty product by EMS Surgical, used by many post-mastectomy breast reconstruction patients. Patented. Specify Cup sizes: A, B, C, D.

Product No. **GATTO**

Compression Garments



3" regular waist



6" high waist

Girdles

Hook and eye, with zipper closure. Available with 3" regular waist or 6" high waist. Above knee or below knee. Available in white, black, or beige.

Sizes: S, M, L, XL.

Product No. **GA92W**
Product No. **GA92HW**



Men's Brief

High wadded. Zipper front opening. Sizes: S, M, L, XL.

Product No. **GAH21**



Men's or Women's To the Knee Girdle

Hook and eye, adjustable. Sizes: S, M, L, XL.

Product No. **GA90KG**

Add **S** for Small, **M** for Medium, **L** for Large, **XL** for Extra Large

LIPOSUCTION & GARMENTS - *Surgical Bras*



Style #9 Bra

Built-up, strain-free shoulder straps. Cotton/spandex with double-lined front. Front closure. 34-38" ABC cup; 40-46" BCD cup.
Product No. **GA9**



Style #958 - E-Z-On™

Lace trim, adjustable Velcro® shoulder straps. Cotton and Lycra® spandex with front zipper closing. Also available with Velcro® front closure or hook and eye front. Cup available. S: 32-34"; M: 34-36"; L: 38-40"; XL: 40-42"; Queen: 44"; Super: 48-50"
Product No. **GA958**



Style #1524 Bra

Features built-up, strain-free shoulder straps. Constructed of nylon and Lycra® spandex. Hook and eye front closing. One cup size only. Sizes: 34-46"
Product No. **GA1524**



D-Bra

Easy to install. Can be used as a wrap and straps slip up after recovery. Latex free. Velcro® front. White only. S; M; L; XL.
Product No. **GADBra**



New D-Bra

Easy to install, 88% nylon, 12% Spandex. Available in white or black. Sizes: 32/34, 36/38, 40/42
Product No. **GAD2**



L-Bra

Slimmer version of our #958. Adjustable shoulder straps. Available with hook and eye closure. Cotton/Lycra®. White only. S: 32-34"; M: 34-36"; L: 38-40"; XL: 40-42"; Queen: 44"; Super: 48-50"
Product No. **GALBra**

Where applicable, add **S** for Small, **M** for Medium, **L** for Large, **XL** for Extra Large, and **XXL** for Double-Extra Large

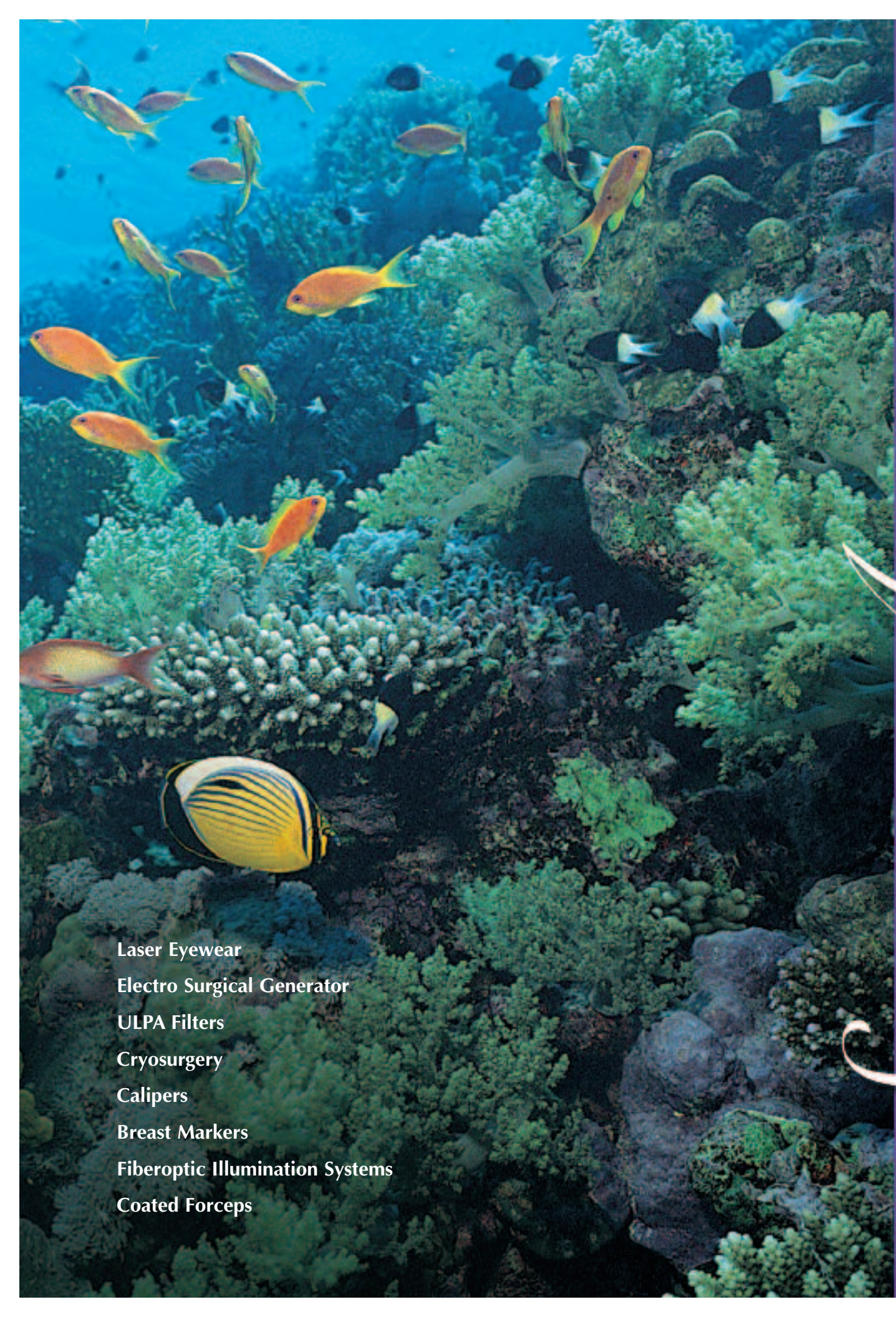

Laser Eyewear
Electro Surgical Generator
ULPA Filters
Cryosurgery
Calipers
Breast Markers
Fiberoptic Illumination Systems
Coated Forceps

SURGICAL ACCESSORIES

SURGICAL ACCESSORIES - Calipers



Castroviejo

Graduated 0-20mm

| Product No. | Description |
|-------------|--------------|
| 190-546 | 8.5cm/3.25in |



Jameson

Graduated in Inches/mm

| Product No. | Description |
|-------------|--------------|
| 190-548 | 9.5cm/3.75in |



Thorpe

Graduated in mm

| Product No. | Description |
|-------------|--------------|
| 190-550 | 9.5cm/3.75in |



Surgical Ruler

Dual Scale in Inches/mm

| Product No. | Description |
|-------------|-------------------------------|
| 270-420 | 15.0cm/6.0in, stainless steel |
| 270-422 | 20.0cm/8.0in, stainless steel |



McKissock Breast Caliper

| Product No. | Description |
|-------------|-------------|
| 201-138 | 38.0mm |
| 201-142 | 42.0mm |
| 201-145 | 45.0mm |



Halpern Breast Caliper

| Product No. | Description |
|-------------|-----------------|
| 201-168 | 38.0mm diameter |
| 201-164 | 34.0mm diameter |

Markers



Barron Areola Marker

Product No.

201-046

Description

Four diameter sizes:
40.0mm, 44.0mm, 48.0mm, 52.0mm



Freeman Areola Marker

Product No.

201-038

201-039

201-042

201-045

Description

38.0mm

38/42mm

42.0mm

45.0mm



D'Assumpcao Flap Marker

Product No. Description

110-397

16.0cm/6.25in



Pitanguy Flap Demarcator

Product No.

110-398

110-399

Description

Small, 15.0cm/6.0in

Large, 25.5cm/10.0in

Suture Needles



Slightly Curved



Curved



Suture Passing Needle (Reverdin)

2.0mm hole tip

Product No.

200-020

200-022

200-024

200-026

Description

Slightly Curved, 15.0cm

Slightly Curved, 21.0cm

Curved, 15.0cm

Curved, 21.0cm



SURGICAL ACCESSORIES - Ocular Shields (for external placement)



FOR NON-LASER APPLICATIONS

- Autoclavable plastic shields
- 1mm thick well-polished edges
- Opaque black or transparent yellow
- Includes suction cup

| Product No. | Description |
|-----------------|-----------------|
| OK23-201 | X-Small: 21.5mm |
| OK23-202 | Small: 25.0mm |
| OK23-204 | Medium: 27.0mm |
| OK23-206 | Large: 28.0mm |

Add **B** for black, **Y** for yellow



- Autoclavable metal shields
- Designed to conform to the globe with a vault over the cornea, the posterior surface and the rounded edges are highly polished, to assure patient's comfort and safety
- With no bulky or heavy handle, each shield includes a suction cup for easy insertion and removal

| Product No. | Description |
|-----------------|------------------------|
| OK21-261 | X-Small: 22.0 x 19.5mm |
| OK21-262 | Small: 24.0 x 21.0mm |
| OK21-264 | Medium: 25.5 x 22.0mm |
| OK21-266 | Large: 26.5 x 23.0mm |
| OK21-268 | X-Large: 28.5 x 26.0mm |

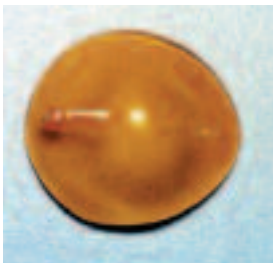

Ocular Shield with Handles

| Product No. | Description |
|------------------|-----------------|
| OK23-201H | X-Small: 21.5mm |
| OK23-202H | Small: 25.0mm |
| OK23-204H | Medium: 27.0mm |

Available in yellow or black

FOR NON-LASER APPLICATIONS



Non-Laser Disposable Eye Shields

Product No. **G31-7300**

- For non-laser use only
 - Easy peel adhesive
 - Latex free and hypoallergenic
 - Allows access to bridge, brow and temples
- Pack of 100

FOR LASER APPLICATIONS



Disposable Laser Eye Shields

Product No. **G31-8300**

- Laser-safe for medical lasers with wavelengths between 190-11,000nm
 - Protection level: (OD>7@190-11,000nm)
 - Latex free and hypoallergenic
- Pack of 50



Add **L** for left, **R** for right

Laser Eye Care Shields

| Product No. | Description |
|------------------|----------------------|
| OK21-262H | Small: 24.0 x 21.0mm |
| OK21-264H | Med: 25.5 x 22.0mm |
| OK21-266H | Large: 26.5 x 23.0mm |

- Vaulted at cornea, marked with size and safety ring at edge
- Offset handle facilitates insertion and removal
- Handle is near lower lid to allow closure without upper lid pressing on handle



SpectraShield™

- Made of opaque lightweight alloy
- Protects against all popular lasers
- Adjustable nose piece and safety strap
- CR certified against direct laser radiation

| Product No. | Description |
|-----------------|--------------------------------------|
| G31-7308 | Black with 4 piece replacement foams |
| G31-7313 | White with 4 piece replacement foams |
| G31-7311 | Replacement foams (12 pc.) |

Laser Eyewear



LightSpeed™ Technology

The adaptation of Liquid Crystal technology from the aerospace and computer world for use in safety eyewear. LightSpeed™ technology allows users to work safer and more efficiently in Intense Pulse Light (IPL) environments.



| Product No. | Description |
|-------------|--|
| G31-90900 | LightSpeed Electronic, OTE eyewear. Responds to IPL light in less than a millisecond |

Cooling Eye and Face Masques



Face Liner

- Maintains Masque's cool temperature and protects the face
- Allows patient to wear the Masque for hours at a time
- Is washable and reusable

| Product No. | Description |
|-------------|-----------------------------------|
| OK29-113 | Liner for Face Masque (pack of 6) |



Cooling Squares

- Important adjunct during Botox and collagen injections, chemical peels, laser hair removal, tattoos and other laser procedures

| Product No. | Description |
|-------------|-----------------------------|
| OK29-112 | Cooling Squares (pack of 4) |

- Important facts:**
- Hypoallergenic and non-toxic
 - Cooling relieves pain and swelling by reducing inflammatory response in blood vessels and limiting blood flow to affected areas

"Clinical tests verify 72 hours of continuous cooling after surgery promotes patient's rapid healing and comfort" — Dr. Tina S. Alster, Founder of Washington Institute of Dermatologic Laser Surgery

Eye and Face Masques



- Stays colder longer than comparable products
- Remains flexible at freezing temperatures
- Distributes coolant evenly
- Velcro straps hold the masque comfortably on the face permitting unrestricted activity



| Product No. | Description |
|-------------|-------------|
| OK29-114 | Eye Masque |

| Product No. | Description |
|-------------|-------------|
| OK29-111 | Face Masque |

Coated Durette® II External Shields

Treated posterior surface of the shields diffuse whatever light penetrates through the skin for greater comfort.

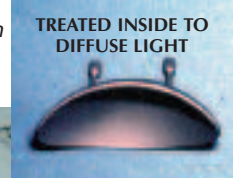

| Product No. | Description |
|-------------|--|
| OK22-345 | Coated Durette® II external laser shields. Includes 1 pair external shields, 2 elastic headbands and a plastic sterilization tray. |

The OPSOFT Mouthguard

- For protection during hair removal and cutaneous treatment with laser, IPL, IPL/RF or RF systems
- Eliminates pain from the laser fluence (and other energy) of the teeth, gums and buccal mucosa
- Better than dental rolls
- Soft rubbery polymer easily conforms to the buccal area
- May be used over dental braces, repair and implants



| Product No. | Description |
|-------------|-------------------------|
| OK60-104 | Single use. 10 per pack |

SURGICAL ACCESSORIES



ESU

MODEL 2001e ElectroSurgical Unit

- 120 watts maximum power output
- Five output modes
- Digital diagnostic error codes
- Hand Control with Optional Foot Control
- One-year warranty

| Product No. | Description |
|-------------|---|
| 300-300A | 110V, includes disposable hand-control pencil, patient pad and manual |

300-300B 220V

Specifications:

Maximum power output by operating mode:

| | |
|------------------------|------------------------|
| Pure Cut = 120 watts | Blend = 90 watts |
| Coagulation = 80 watts | Fulguration = 40 watts |
| | Bi-Polar = 30 watts |



PURE-VAC™ Smoke Evacuation System



"Cart mountable". Includes footswitch. Strong, quiet unit with "single use" filter. Excellent for use when cross contamination may be a problem.

Product No. 300-349

Hand Control ElectroPencil

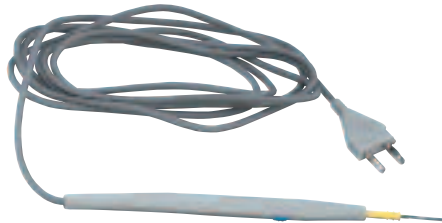

| Product No. | Description |
|-------------|---|
| 300-510 | ElectroPencil for hand or foot control to be used with ESU unit |
| 300-516 | Reusable, 3 Prong Fitting |
| 300-515 | Sterile, disposable, 3 Prong Fitting, box of 20 |



SURGIFRESH™ Mini Turbo

110V-120V/50&60HZ
Includes Footswitch

| Product No. | Description |
|-------------|-------------|
| 300-350 | 110V-120V |
| 300-351 | 220V |

Wheel Kit Assembly

Product No. 300-352

Reusable Electrodes - Cutaneous Surgery

Standard 3/32" diameter shaft. Working length: 2-2 1/2". One per pack. Improved full shaft insulation. Tapered shaft fits easily in any handpiece.



Product No.
P900-6424
Description
Blade



Product No. Description
P900-6403 Small Ball
P900-6404 Large Ball



Product No. Description
P900-6408 Straight Needle, broad
P900-6405 Fine Needle, short
P900-6411 Adjustable Needle
P900-6410 Broad Needle, short
P900-6409 Broad Needle, long



K30-8012 4 1/2" Tungsten, insulated, Angled Tip 45°



K30-8013 6 5/8" Tungsten, insulated, Straight



K30-8015 4" Tungsten, insulated, Curved



K30-8016 5 7/8" Tungsten, insulated, Curved



K30-8017 4 7/8" Tungsten, insulated, Angled Tip 45°

Micro Dissection Needles



K30-8000 1 1/4" Tungsten, insulated, Straight



K30-8006 1 5/8" Tungsten, insulated, Straight



K30-8007 1 5/8" Tungsten, insulated, Angled Tip 45°



K30-8008 2" Tungsten, insulated, Straight



K30-8009 2" Tungsten, insulated, Angled Tip 45°

ULPA Filters, Tubing & Accessories



ULPA-Smoke™

Product No. **305-833**
 Description Non-sterile
 ULPA filter with activated Carbon.
 For use with Surgifresh™ system
 (3 to a case)



ULPA-YAG™

Product No. **300-821**
 Description Non-sterile
 VLSI Grade 2 ULPA filter with odor control activated Carbon for use with Erbium: YAG Laser System.
 For Surgifresh™ unit.
 (1 per case)

Please contact your Marina Medical Account Manager for a complete list of all your ESU and Smoke Evacuation Accessories



For use with all PURE-VAC™ Smoke Evacuation Systems

ULPA-Clear™

Product No. **300-822**
 Description Non-sterile
 VLSI Grade 2 ULPA **1 HOUR** disposable filter with odor control activated Carbon.



Disposable Pre-Filter

7/8in (22.0mm) port
 Product No. **300-837**
 Description
 6in O.D., case of 10



Tubing Connector (Reducers)

Description Product No.
 3/8in to 1 1/3in **300-838**
 7/8in to 1 1/3in **300-839**

Box of 3



Footswitch

For Surgifresh™
 Product No. **300-823**

For PURE-VAC™
 Product No. **300-824**

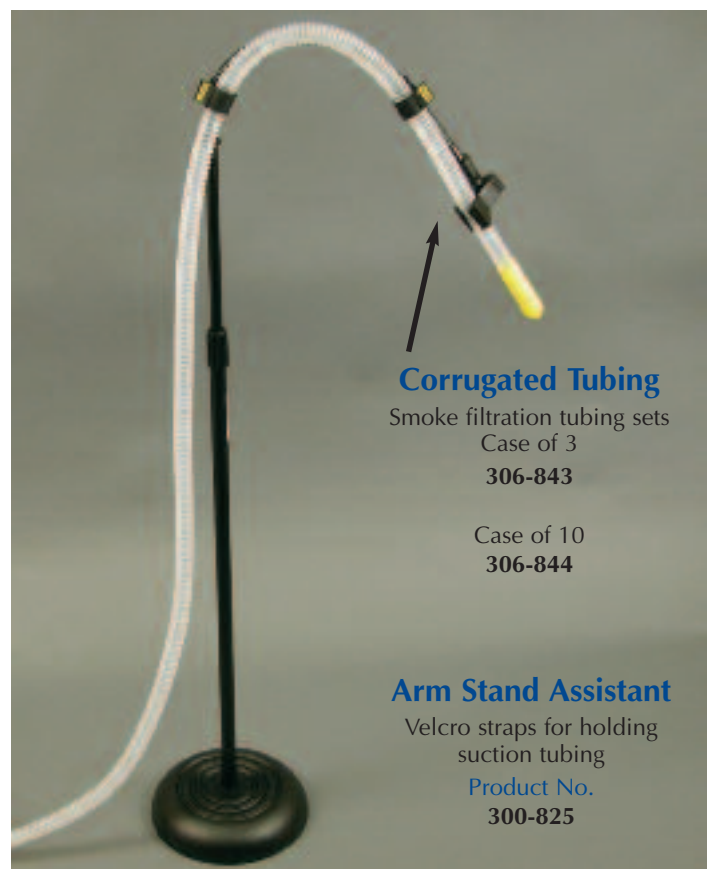

Corrugated Tubing

Smoke filtration tubing sets
 Case of 3
306-843

Case of 10
306-844

Arm Stand Assistant

Velcro straps for holding suction tubing
 Product No. **300-825**

SURGICAL ACCESSORIES - Cryosurgery



P-100-6065



P-100-6060

Nitrospray Plus

- Improved seal eliminates O-ring positioning
- Grooved head, curved trigger
- Easy to use, comfortable to hold
- Three year warranty

Static holding time: 8-12 hours. Intermittent use: 3-6 hours of patient treatment time.

| Product No. | Description |
|------------------|--|
| P100-6060 | 16oz fill capacity. Includes 5 spray tips, tip protector and base holder |
| P100-6065 | 10oz fill capacity. Includes 5 spray tips, tip protector and base holder |
| P100-6066 | Pressure seal ring |

Spray Tips

Reusable and safe



| Product No. | Description |
|------------------|----------------------|
| P100-6516 | 16 gauge, purple |
| P100-6517 | 17gauge, white |
| P100-6518 | 18 gauge, gray |
| P100-6519 | 19 gauge, brown |
| P100-6520 | 20 gauge, yellow |
| P100-6525 | Spray tips, set of 5 |

Miscellaneous Accessories



| Product No. | Description |
|------------------|---------------------|
| P100-6527 | Spray Tip Protector |



| Product No. | Description |
|------------------|----------------------|
| P100-6530 | Bent Spray Extension |



| Product No. | Description |
|------------------|------------------------|
| P100-6700 | Needle Extender, rigid |



| Product No. | Description |
|------------------|---------------------------|
| P100-6521 | Brymill Accessory Adapter |

Cutaneous Probes

Reusable vent tube provided with each probe.



| Product No. | Description |
|------------------|----------------------|
| P100-6602 | Cutaneous Probe, 2mm |



| Product No. | Description |
|------------------|----------------------|
| P100-6604 | Cutaneous Probe, 4mm |



| Product No. | Description |
|------------------|----------------------|
| P100-6606 | Cutaneous Probe, 6mm |



| Product No. | Description |
|------------------|----------------------|
| P100-6608 | Cutaneous Probe, 8mm |



| Product No. | Description |
|------------------|-----------------------|
| P100-6610 | Cutaneous Probe, 10mm |



| Product No. | Description |
|------------------|------------------------|
| P100-6620 | Cutaneous Probe, Sharp |

One-Step Hair Restoration System

The One-Step Hair Restoration System is applicable to situations where there is thinning hair. There are four sizes of hair transplanters available ranging from 0.8mm diameter which is suitable for single hair graft, reconstruction eyebrows, eyelashes, beards, and the pubic region. The 1.0mm diameter is suitable for transplanting 1 - 2 hairs. The 1.3mm diameter is suitable for transplanting a bundle of 3 - 4 hairs. And the 1.5mm is suitable for transplanting a bundle of 5 - 6 hairs.

For Doctors:

- Easy to use: One-Step Hair Restoration System, no need to make holes separately
- Insure totally natural-looking hair transplants
- Time for a complete restoration is short
- Minimal bleeding
- Local anesthetic

For Patients:

- Provides a superior, undetectable natural result
- There is a fast healing time
- No additional maintenance required
- No bandage or dressing is required
- Minimal or no scarring



Sold as a kit or each needle sold separately

| Product No. | Description |
|-------------|-------------------------------------|
| 33-HN08 | Replaceable needle for 33-HT08 |
| 33-HN10 | Replaceable needle for 33-HT10 |
| 33-HN13 | Replaceable needle for 33-HT13 |
| 33-HN15 | Replaceable needle for 33-HT15 |
| 33-HT08 | Hans Hair Transplanter 0.8mm (each) |
| 33-HT10 | Hans Hair Transplanter 1.0mm (each) |
| 33-HT13 | Hans Hair Transplanter 1.3mm (each) |
| 33-HT15 | Hans Hair Transplanter 1.5mm (each) |
| 33-HT101 | Cutting Board |
| 33-HT408 | Blade Holder |

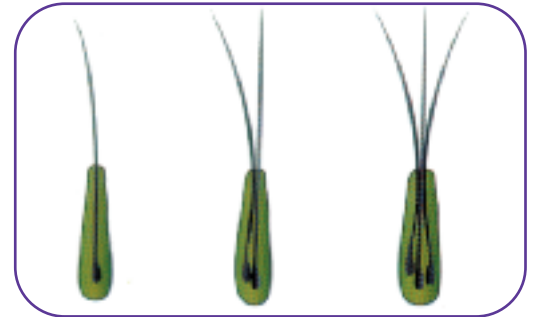

Hairgrafts (single or bundle hair).



A single hair graft being placed on the needle with smooth forceps.

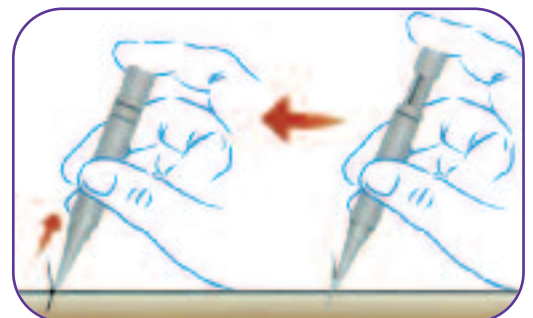

The HANS hair transplanter in place.

**Free Instructional CD
upon request.
Product No. 33-HTV**

SURGICAL ACCESSORIES - Sterilization & Infection Control



Manual Kwiklave (M/MK)

| Product No. | Description |
|------------------|---------------------------------|
| T1730M/MK | 2 gallon, 6.7" x 13.4" chamber |
| T2340M/MK | 5 gallon, 9.0" x 18.5" chamber |
| T2540M/MK | 6 gallon, 10.0" x 18.7" chamber |
| T3870M | 22gallon, 15.1" x 29.9" chamber |

MK Series reduces sterilization time by 50%

- Auto shut off
- Overheat cutoff
- Double safety lock
- Dual safety thermostats



Automatic Kwiklave (EA/EKA)

| Product No. | Description |
|-------------------|----------------------------------|
| 2340EA/EKA | 5 gallon, 9.0" x 18.5" chamber |
| 2540EA/EKA | 6 gallon, 10.0" x 18.7" chamber |
| 3870EA | 22 gallon, 15.1" x 29.9" chamber |

EKA Series reduces sterilization time by 50%

- Auto shut off
- Overheat cutoff
- Fills, sterilizes, exhausts and dries at the touch of a button
- Closed-door active drying system
- Pre-loaded cycles
- Dual safety thermostats



Valueklave 1730

| | |
|-------------|--------------|
| Product No. | T1730 |
| Description | 7" chamber |

- Fast cycle time. 9 minutes from a hot start (standard unwrapped cycle time)
- Automatic shut off at the end of both the sterilization and dry cycles
- Double safety lock
- Overheat cutoff
- Dual safety thermostats
- One year warranty on parts and labor
- Speed and quality you demand with the value you deserve



Chamber Brite Autoclave Cleaner

- Cleans and descales chamber, reservoir, and copper tubing of most steam autoclaves
- Pre-measured packs
- No pre-mixing required
- Odor free
- 10 Single Use package

Product No. **TCB0010**



Brite Shield Static Soak & Ultrasonic Cleaner

Product No.
P901-1100
Description
800gm container

- Ideal for removing bio-burden from hand instruments
- Polishes and protects with unique passivation process to restrict rust and corrosion

Sterilization Containers



Polyvinyl Containers

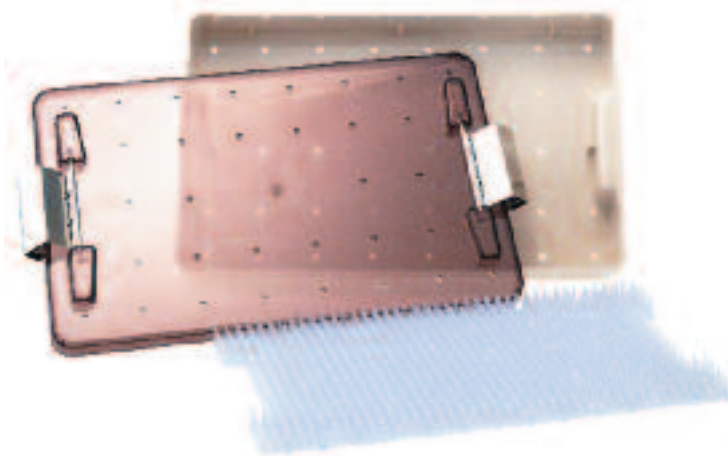

Autoclavable with silicone mat

| Product No. | Description |
|-------------|---------------------|
| 300-201 | 11.0 x 7.0 x 1.0in |
| 300-202 | 11.0 x 7.0 x 1.75in |

*Other sizes available.
Please contact your Marina
Medical Account Manager.*

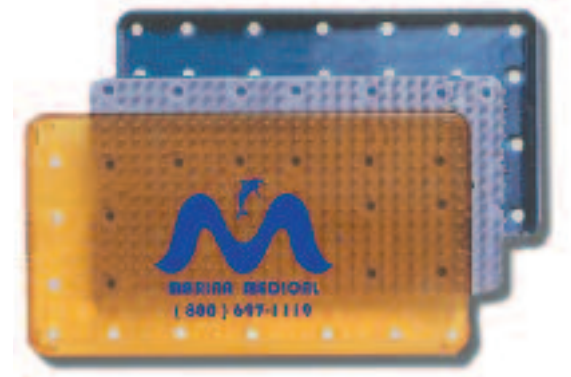

Autoclavable with silicone mat

| Product No. | Description |
|-------------|-------------------|
| 300-200 | 7.0 x 3.0 x 1.0in |

Aluminum Containers



| Product No. | Description |
|-------------|--|
| R642.07 | Container, perforated lid/bottom 500 x 155 x 75mm |



| Product No. | Description |
|-------------|---|
| R310.10 | Container, perforated lid, unperforated bottom 280 x 280 x 100mm, gray |
| R311.10 | Container, perforated lid, perforated bottom 280 x 280 x 100mm, gray |
| R310.10B | Basket for container size 280 x 280 x 100mm |

Instrument Identification Tape



Tape in rolls

| Product No. | Description | |
|-------------|-------------|--|
| 151-001 | White | |
| 151-002 | Blue | |
| 151-003 | Kelly Green | |
| 151-004 | Red | |
| 151-005 | Yellow | |
| 151-006 | Purple | |
| 151-007 | Orange | |
| 151-009 | Black | |

SURGICAL ACCESSORIES - *Fiberoptic Illumination Systems*

Marina Medical offers a complete line of headlight components to enable you to get the perfect headlight system for your needs. Choose the headlight, headband and fiberoptic cable style you prefer. Headlight fiberoptic cables have an ACMI™ light source end-fitting, but are available to fit other brands. Each headlight has a unique design to allow for a complete range of motion from side to side and up and down.



For Variable Bifurcated, add VB
to the product number.
For Variable, Single, add V
to the product number.
For Fixed Bifurcated, add FB
to the product number.
For Fixed Single, add F
to the product number.

All headlight systems include:

- Headlight module
- Headband
- Fiberoptic cable (single or bifurcated)
- 2 garment clips
- Duffel bag



Deluxe Plus Headband

- Ratchet style crown and rear tension adjustment
- Replaceable Breath-O-Prene comfort liners to wipe away sweat from front and back

Product No. 5-DHCK5000

Deluxe Headband

- Clip style crown tension adjustment
- Ratchet style rear tension adjustment
- Replaceable Breath-O-Prene comfort liners

Product No. 5-DHC5000



Standard Headband

- Economical design with plastic matte finish
- Clip style crown tension adjustment
- Ratchet style rear tension adjustment
- Replaceable leather-like comfort liner

Product No. 5-HLC5000



Ultra Comfort Headband

- Flexible design
- Breath-O-Prene fabric with unique "open construction" provides maximum breathability
- Fully washable to minimize skin irritation and moisture problems
- Ultra light weight for comfort

Product No. 5-UHC5000

Instrumentation Sets

Plastic Surgery Sets

- 050-304 Iris Scissors - Straight, Standard: 11.5cm/4.5in
- 050-305 Iris Scissors - Straight, Serrated: 11.5cm/4.5in
- 050-180 Metzenbaum Dissecting Scissors - Curved: 14.5cm/5.75in
- 050-426 Ragnell Flat Tip Scissors, Curved, 12.0cm/4.75in
- 400-932 Kaye Rhytidectomy Scissors, Curved, TC Blades : 15.0cm/6.0in
- 060-126 Adson Forceps with Tying Platform, No Teeth, Standard Tip, Serrated, 12.0cm/4.75in
- 060-137 Adson Tissue Forceps - Straight, 1x2 Teeth, Serrated Tying Platform: 12.0cm/4.75in
- 060-170 Adson-Brown Tissue Forceps - Straight, 9x9 Teeth: 12.0cm/4.75in
- 070-002 Halsted Mosquito Forceps - Straight, Standard: 13.0cm/5.25in
- 070-004 Halsted Mosquito Forceps - Curved, Standard: 13.0cm/5.25in
- 070-504 Backhaus Towel Clip: 9.0cm/3.5in
- 070-506 Backhaus Towel Clip: 13.5cm/5.25in
- 080-060 Webster Needle Holder - Serrated Jaws: 13.0cm/5.0in
- 080-100 Crilewood Needle Holder - Serrated Jaws: 15.0cm/6.0in
- 110-076 Senn Retractor - Blunt: 16.0cm/6.25in
- 110-122 U.S. Army Retractor - Set of Two: 21.5cm/8.5in
- 110-321 Volkman 4 Prong Retractor, Blunt : 21.5cm/8.5in
- 160-115 Allis Forceps - 4x5 Teeth: 15.0cm/6.0in
- 190-639 Frazier Suction Tube, 9fr
- 190-180 Joseph Skin Hook, Single Prong, 15.0cm/6.0in
- 190-182 Joseph Skin Hook, Double Prong, 5.0mm width, 15cm/6.0in

Blepharoplasty Sets

- 050-402 Stevens Tenotomy Scissors - Blunt/Blunt, Curved: 12.5cm/5.0in
- 060-411 Iris Tissue Forceps, 1/2 Curved, 1 x 2 Teeth, 10.0cm/4.0in
- 440-319 Blepharoplasty Forceps. Diamond Insert, Delicate Hooks on Adson Forceps
- 440-321 Blepharoplasty Forceps. TC Inserts , Standard Hooks on Adson Forceps with Platform
- 440-323 Blepharoplasty Forceps. Extra Fine Hooks on Castroviejo Forceps
- 400-927 Blepharo Scissors - Curved, Flat Narrow Tip, Serrated TC Blades: 13.5cm/5.25in
- 420-075 Halsey Needle Holder - Straight, Serrated Jaws, TC Inserts: 13.0cm/5.0in
- 070-005 Halsted Micro Mosquito Forceps - Curved, Delicate: 13.0cm/5.25in
- 070-504 Backhaus Towel Clip: 9.0cm/3.5in
- 110-050C Desmarres Lid Retractor - 10.0mm, Insulated: 14.0cm/5.5in
- 110-054C Desmarres Lid Retractor - 14.0mm, Insulated: 14.0cm/5.5in
- 110-046C Jaeger Lid Plate - Non-Conductive Coated Stainless Steel: 11.0cm/4.25in
- 190-168 Frazier Dura Hook - Blunt: 12.5cm/5.0in
- 190-546 Castroviejo Caliper
- 060-420 Green Fixation Forceps, without Lock : 10.0mm wide, 10.0cm/4in

Suture Sets

- 040-070 Scalpel Handle #3 - for Blade sizes # 10-18: 13.0cm/5.0in, Graduated in Cms
- 050-425 Ragnell Flat Tip Scissors, Straight, 12.0cm/4.75in
- 050-016SC Operating Scissors - Straight, Blunt/Sharp, Supercut: 14.5cm/5.75in
- 060-117 Adson Dressing Forceps - Straight, Fine: 12.0cm/4.75in
- 060-134 Adson Tissue Forceps - Straight, 1 x 2 Teeth, Fine: 12.0cm/4.75in
- 070-002 Halsted Mosquito Forceps - Straight, Standard: 13.0cm/5.25in
- 070-004 Halsted Mosquito Forceps - Curved, Standard: 13.0cm/5.25in, **Quantity 2**
- 070-036 Kelly Hemostatic Forceps - Straight: 14.0cm/5.5in
- 070-038 Kelly Hemostatic Forceps - Curved: 14.0cm/5.5in
- 070-504 Backhaus Towel Clip: 9.0cm/3.5in, **Quantity 2**
- 420-100 Crilewood Needle Holder - Straight, TC Inserts:15.0cm/6.0in

Mohs Surgery Sets

- 040-070 Scalpel Handle #3 - for Blade sizes #10-18: 13.0cm/5.0in, Graduated in Cms
- 040-101 Scalpel Blade Remover: 15.0cm/6.0in
- 050-012 Operating Scissors - Straight, Blunt/Sharp: 11.5cm/4.5in
- 050-702SC Iris Scissors - Curved, Supercut: 11.0cm/4.25in
- 060-136 Adson Tissue Forceps - Straight, 1 x 2 Teeth, Smooth platform: 12.0cm/4.75in
- 070-002 Halsted Mosquito Forceps - Straight, Standard: 13.0cm/5.25in
- 070-005 Halsted Micro Mosquito Forceps - Curved, Delicate: 13.0cm/5.25in
- 070-504 Backhaus Towel Clip: 9.0cm/3.5in
- 173-825 Bishop-Harmon Forceps - 1 x 2 .5mm Teeth: 9.0cm/3.5in
- 190-173 Lahey Single Skin Hook, 12.0cm/4.75in
- 190-202O Fox Dermal Curette, 2.0mm Tip
- 420-060 Webster Needle Holder - Straight, Serrated Jaws, TC Inserts: 13.0cm/5.0in
- 420-090 Baumgartner Needle Holder - Straight, Serrated Jaws, TC Inserts: 14.0cm/5.5in

A

| | |
|---|-------|
| Accessories | 75 |
| Adson Forceps | 26-27 |
| Adson-Brown Forceps | 26 |
| Agris-Dingman Transauxillary Breast Dissector | 41 |
| Alar Morselizer | 59 |
| Alligator/Cupped Forceps | 62 |
| Allis Clamps | 31 |
| Alm Skin Retractor | 45 |
| Aluminum Containers | 85 |
| Anderson Retractor | 48 |
| Areola Markers | 77 |
| Arm Stand Assistant | 81 |
| Aspirators, Infusion & Tubing | 71 |
| Aufricht Nasal Rasp | 55 |
| Aufricht Nasal Retractor | 42 |
| Autoclave | 84 |
| Autoclavable Cleaner | 84 |

B

| | |
|--------------------------------------|-------|
| Baby Gerzog Mallet | 58 |
| Baby Lexer | 15 |
| Baby Webster Needle Holder | 36 |
| Backhaus Towel Clip | 33 |
| Ballenger Swivel Knife | 56 |
| Barraquer (Kurth) Forceps | 30 |
| Barraquer Micro Needle Holder | 38 |
| Barron Areola Marker | 77 |
| Barsky Skin Hook | 46 |
| Beyer Rongeur | 61 |
| Biggs Mammoplasty Retractor | 40 |
| Billeau Ear Loops | 52 |
| Breast Binders | 73 |
| Biopsy Punches | 64 |
| Bi-Polar Forceps | 28 |
| Bishop-Harmon Suture Forceps | 29 |
| Blepharoplasty Forceps | 29 |
| Blepharoplasty Scissors | 17 |
| Bow Retractors | 45 |
| Bowls | 64 |
| Breast Retractors & Dissectors | 40-41 |
| Brite Shield | 84 |
| Buck Ear Currettes | 52 |

C

| | |
|-------------------------------------|-------|
| Calipers | 76 |
| Camera (Endo) | 10 |
| Cannulas & Tubing | 70 |
| Cannula Bases | 70 |
| Cannula Handles | 70 |
| Carmalt Splinter Forceps | 30 |
| Carroll Tendon Cupped Forceps | 62 |
| Cartilage Crushers | 59 |
| Cartilage Crushing Box | 59 |
| Castroviejo Caliper | 76 |
| Castroviejo Micro Scissors | 24 |
| Castroviejo Needle Holder | 38 |
| Castroviejo Suturing Forceps | 29 |
| Chamber Brite | 84 |
| Chisels/Osteotomes | 56-57 |
| Cinelli Osteotome | 57 |
| Closed Ring Gradle Scissors | 17 |
| Cleveland Rongeur | 61 |
| Comedone Extractors | 66 |
| Compression Garments | 73 |

| | |
|---|----|
| Containers, Sterilization | 85 |
| Converse Alar Retractor | 50 |
| Converse Nasal Retractors | 50 |
| Converse Scissors | 21 |
| Cottle Osteotome | 57 |
| Cottle Columella Clamp | 59 |
| Cottle Nasal Speculum | 50 |
| Cottle (Parkes) Rasp | 55 |
| Cottle Periosteal Elevator | 51 |
| Cottle Septum Elevator | 51 |
| Coronal Brow Lift Retractor | 48 |
| Cottle Dorsal Angled Shanks Scissors | 20 |
| Cottle-Neivert Retractor/Needle Guide | 47 |
| Cottle Thumb Hook | 47 |
| Crile-Rankin Hemostatic Clamp | 32 |
| Crilewood Needle Holder | 36 |
| Cryosurgery | 82 |
| Currettes | 52 |
| Curette Blades (Disposable) | 65 |
| Cushing Specialty Forceps | 31 |
| Cushing Bayonet Forceps | 31 |
| Cutaneous Probes | 82 |
| Cutaneous Surgery | 80 |

D

| | |
|---|-------|
| D'Assumpcao Flap Marker | 77 |
| Davis Scissors | 22 |
| Deaver Retractor | 43 |
| DeBakey Tissue Forceps | 27 |
| Dermal Currettes | 65 |
| Dermatology | 63-68 |
| Desmarres Chalazion Clamp | 34 |
| Desmarres Lid Retractor | 44 |
| Derf Needle Holder | 36 |
| Di Breast Clamp | 34 |
| Dingman Otopraders | 53 |
| Dissecting Scissors | 14-15 |
| Dorsal Osteotome (Rubin) | 60 |
| Double-Ended Desmarres Retractor | 44 |
| Double-Ended Disposable Ear Currettes | 52 |
| Double-Ended Breast Retractor | 40 |
| Double Prong Thimble Hook | 47 |
| Double Spring Nail Nippers | 67 |
| Dressing & Tissue Forceps | 26-27 |

E

| | |
|---|-------|
| Ear Currettes, Double-Ended, Disposable | 52 |
| Ear Loops, Billeau | 52 |
| Ear, Nose & Throat | 49-62 |
| Electrodes, Reusable | 80 |
| Electrosurgical Unit | 80 |
| Endoscopic | 4-10 |
| Endoscopic Dissectors | 6-7 |
| Endoscopic Endobrow | 5 |
| Endoscopic Equipment | 10 |
| Endoscopic Retractors | 8-9 |
| Endoplastic Graspers & Scissors | 5 |
| Endoscopic Sheaths | 4 |
| English Anvil Nail Splitter | 67 |
| Electrosurgical Unit (ESU) | 80 |
| Extractors | 66 |
| Eye Shields | 78 |

F

| | |
|---|-------|
| Feilchenfeld Splinter Forceps | 30 |
| Ferriera Style Retractor | 8-9 |
| Fiberoptic Cord (Autoclavable) | 9 |
| Fiberoptic Illumination Systems | 86 |
| Foerster Sponge Forceps | 34 |
| Fomon Lower Lateral Alar Scissors | 20 |
| Fomon Dorsal Angled Shanks Scissors | 20 |
| Fomon Nasal Rasps | 54 |
| Fomon Skin Hooks | 46 |
| Footswitch | 81 |
| Forceps & Clamps | 25-34 |
| Fox Currettes | 65 |
| Frazier Dura Separator | 65 |
| Frazier Skin Hook | 46 |
| Freer Elevators | 51 |
| Freeman Areola Marker | 77 |
| Freeman Flap Retractor (Lighted) | 43 |
| Freeman Rake Retractor | 48 |
| Friedman Rongeur | 61 |

G

| | |
|---|----|
| Garments for Liposuction | 72 |
| General Series (Scissors) | 12 |
| Gelpi Retractor | 45 |
| Gillies Needle Holder | 37 |
| Glabellar Rasp | 55 |
| Glass Bead Mirror Warmer | 53 |
| Goldman-Fox Scissors | 18 |
| Gorney Rake Spring Neck Retractor | 48 |
| Gorney Scissors | 22 |
| Gradle Scissors (Open & Closed) | 17 |
| Graefe (Iris) Skin Hook | 46 |
| Green Fixation Forceps | 29 |
| Griffith Brown Forceps | 29 |
| Guthrie Skin Hook | 46 |

H

| | |
|--|----|
| Halpern Breast Caliper | 76 |
| Hair Restoration | 83 |
| Hair Restoration Forceps | 28 |
| Halsey Needle Holder | 36 |
| Halsted Mosquito (Adson) Forceps | 32 |
| Halsted Mosquito Forceps | 33 |
| Hand Control ElectroPencil | 80 |
| Hartmann Alligator | 62 |
| Hartmann Cup Forceps | 62 |
| Hartmann Mosquito Forceps | 33 |
| Heaney/Simon Retractor | 43 |
| Heavy Pattern Nail Nippers w/ Lock | 67 |
| Heiss Retractor | 45 |
| Hemostatic Clamps | 32 |
| Hemostatic Forceps | 33 |
| Hercules™ Aspirator | 71 |

I

| | |
|--|-------|
| Infiltration Tubing | 71 |
| Infusion Cannulas | 70 |
| Infusion Pump | 71 |
| Instrument Identification Tape | 85 |
| Instruments for Forehead & Facelift Endoscopy4 | |
| Instrumentation Sets | 87-88 |
| Iris (Graefe) Forceps | 27 |

| | | | |
|---|-------|--|-----------|
| J | | | |
| Jaeger Lid Plate Retractor | 44 | Mixer Hemostatic Clamp | 32 |
| Jameson Caliper | 76 | Monitors (Endo) | 10 |
| Jansen Bayonet Forceps | 31 | Myomectomy Scissors | 17 |
| Jeweler Forceps..... | 28 | N | |
| Joseph Elevator..... | 51 | Nail Nippers..... | 67 |
| Joseph Skin Hook | 47 | Nasal Frontal Osteotome (Rubin) | 60 |
| Joseph Nasal Rasp | 54 | Nasal Lateral Osteotome (Rubin) | 60 |
| Jones Towel Clip | 33 | Nasal Rasps | 54-55, 60 |
| Joseph Scissors | 21 | Nasal Scissors | 20-21 |
| Joseph-Peck Scissors | 21 | Nasal Series Specialty Retractors | 50 |
| K | | Needle Holders..... | 35-38 |
| Kasden Double-Ended Retractor | 44 | Neivert Needle Holder | 37 |
| Kaye Scissors | 22 | Neivert Osteotome..... | 56 |
| Kelly Scissors | 16 | Nitrospray Plus | 82 |
| Kelly-Rankin Hemostatic Clamp | 32 | O | |
| Keyes Dermal Biopsy Punch Set | 64 | O'Brien Stitch Removal Scissors..... | 19 |
| Killian Nasal Speculum | 50 | Olsen-Hegar Needleholders w/Scissors | 38 |
| Kleinert-Kutz Skin Hook | 47 | Eye Shields | 79 |
| L | | Open Ring Gradle Scissors | 17 |
| LaGrange (S-curved shanks) Scissors | 16 | Open Ring Iris Scissors | 13 |
| Lahey Skin Hook | 46 | Operating Scissors | 12 |
| Lambotte Osteotome..... | 57 | P | |
| Laryngeal Mirrors with Handle | 53 | Parkes Nasal Elevator | 51 |
| Laser Eyewear | 78-79 | Suture Passing Needle | 77 |
| Lempert Rongeur | 61 | Peet Cottle Rasp | 55 |
| Lewis (Joseph) Nasal Rasp..... | 54 | Periosteal Elevators..... | 51 |
| Lighted Freeman Flap Retractor | 43 | Phlebectomy Hook Set | 47 |
| Light Sources | 10 | Pitanguy Flap Demarcator | 77 |
| Liposuction | 70 | Potts-Smith Forceps | 27 |
| Liposuction & Garments | 69-74 | R | |
| Lister Bandage Removal Scissors..... | 19 | Ragnell-Davis Retractor | 44 |
| Liston Bone Cutter | 61 | Ragnell (Kilner) Scissors..... | 15 |
| Littauer Cilia Forceps..... | 30 | Rake Retractors..... | 48 |
| Littauer Stitch Removal Scissors | 19 | Rees Scissors | 22 |
| Littler Scissors | 16 | Retractors | 42-43 |
| Lorna (Edna) Towel Clip | 33 | Retractors & Skin Hooks | 39-48 |
| Lucae Mallets | 58 | Reverdin Needle | 77 |
| Lucae Specialty Forceps | 31 | Reynolds Tenotomy Scissors | 18 |
| M | | Reynolds Transauxillary Breast Dissector | 41 |
| MacCollum-Dingman Transauxillary | | Rhytidectomy Scissors | 22-23 |
| Breast Dissector..... | 41 | Ribbon Retractors | 42 |
| Maliniac Nasal Retractors | 50 | Rimometer, Rubin | 59 |
| Mallets..... | 58 | Rochester-Oschner (Kocher) Clamp | 32 |
| Maltz Rasp | 55 | Rochester-Pean Hemostatic Clamp | 32 |
| Marina Dermal Currettes | 65 | Rollet (Knapp) Retractor | 46 |
| Marina Spoon Extractor | 66 | Rongeurs & Bone Cutters | 61 |
| Markers, Breast..... | 77 | Rubin Rhinoplasty Set | 59-60 |
| Mayo-Hegar Needle Holder | 37 | Ruler, Surgical..... | 76 |
| Mayo Scissors..... | 14 | Ruskin-Liston Bone Cutter | 61 |
| Mayo Noble Scissors | 14 | Ruskin Ronguer | 61 |
| McKenty Elevator | 51 | S | |
| Mead Mallet..... | 58 | Saalfeld Extractors | 66 |
| Metzenbaum Scissors | 14 | Self-Retaining Skin Retractors | 45 |
| Meyhoefer Currettes | 65 | Semken Forceps | 26 |
| Micro Cannulas | 70 | Senn-Mueller Retractor | 44 |
| Micro Dissection Needles | 80 | Septal Morselizer..... | 59 |
| Micro Forceps | 29 | Scalpel Handles..... | 68 |
| Micro Hook Scissors..... | 5 | Scalpels..... | 68 |
| Micro Metzenbaum Scissors | 5 | Scalpel Blade Remover | 68 |
| Micro Needle Holders | 38 | Schamberg Extractors..... | 66 |
| Micro-Ryder Needle Holder..... | 37 | Scissors..... | 11-23 |
| Micro Scissors | 24 | Shalita Expressor Extractor | 66 |
| Millard Double Thumb Hook | 47 | Sheehan Osteotome | 57 |
| Mini-Friedman Rongeur | 61 | Silver Nasal Osteotome | 56 |
| Mirrors & Accessories | 53 | | |
| McKissock Breast Caliper | 76 | | |
| | | Skin Hook Retractors..... | 46-47 |
| | | Smoke Evacuation Systems | 80 |
| | | Special Retractors | 44 |
| | | Specialty Forceps | 29 & 31 |
| | | Specialty Series Scissors | 16-17 |
| | | SpectraShield™ | 78 |
| | | Spencer Stitch Scissors | 19 |
| | | Splinter & Suture Removal Forceps | 30 |
| | | Spray Tips..... | 82 |
| | | Standard Iris Scissors Series | 13 |
| | | Sterilization Containers | 85 |
| | | Sterilization & Infection Control | 84 |
| | | Stevens Tenotomy Scissors | 18 |
| | | Stitch Removal Scissors Series | 19 |
| | | Strabismus Scissors | 15 |
| | | Strut Forceps (Rubin) | 60 |
| | | Suction Coagulator | 4 |
| | | Surgical Accessories | 75 |
| | | Surgical Bras..... | 74 |
| | | SURGIFRESH™ Smoke Evacuator | 80 |
| | | Swiss Cilia Forceps | 30 |
| | | T | |
| | | Takahashi Cupped Forceps | 62 |
| | | Taylor Bayonet Forceps | 31 |
| | | Taylor Forceps | 31 |
| | | Tebbetts Style Retractor | 8 |
| | | Telescope for Plastic Endoscopy..... | 4 |
| | | Tenotomy Scissors Series..... | 18 |
| | | Thorpe Caliper..... | 76 |
| | | Tissue Wound Retractors | 45 |
| | | Tolsdorf Cartilage Crusher..... | 59 |
| | | Towel Forceps | 33-34 |
| | | Truswell Trocar | 62 |
| | | Tubingen Tying Forceps..... | 29 |
| | | Turnbull Barrel Spring Nail Nippers..... | 67 |
| | | Tyrell (Iris) Skin Hook | 46 |
| | | U | |
| | | ULPA Filters, Tubing & Accessories | 81 |
| | | Unna Comedone Extractors..... | 66 |
| | | U.S. Army (Parker-Langenbeck) Retractor | 42 |
| | | V | |
| | | V-Pal Sub Sonic Surgical System | 71 |
| | | Vascular (Delicate) Needle Holder..... | 37 |
| | | Vannas Micro Scissors | 24 |
| | | Vienna Nasal Speculum..... | 50 |
| | | Virtus Splinter Forceps | 30 |
| | | W | |
| | | Walton (Katsch) Extractor | 66 |
| | | Webster Needle Holder | 36 |
| | | Weitlaner Retractor | 45 |
| | | Westcott Stitch Micro Scissors | 24 |
| | | Westcott Utility Micro Scissors | 24 |
| | | Wheel Kit Assembly | 80 |
| | | Wieder Tongue Depressor | 42 |
| | | Wilde Specialty Forceps | 31 |
| | | Williger Elevator | 51 |
| | | Wilmer (Converse) Angled on Flat Scissor | 21 |
| | | Wire Cutting Scissors | 16 |
| | | Y | |
| | | Yancoskie Abdominoplasty Retractor | 48 |



955 Shotgun Road
Sunrise, Florida 33326 USA

Tel: (954) 924-4418
Toll-Free: (800) 697-1119
Fax: (954) 924-4419
Toll-Free Fax: (800) 748-2089
www.marinamedical.com

PRESORTED
STANDARD
U.S. POSTAGE
PAID
FT. LAUD., FL
PERMIT NO. 5158