

# MARINA MULTIple reTRACtor™

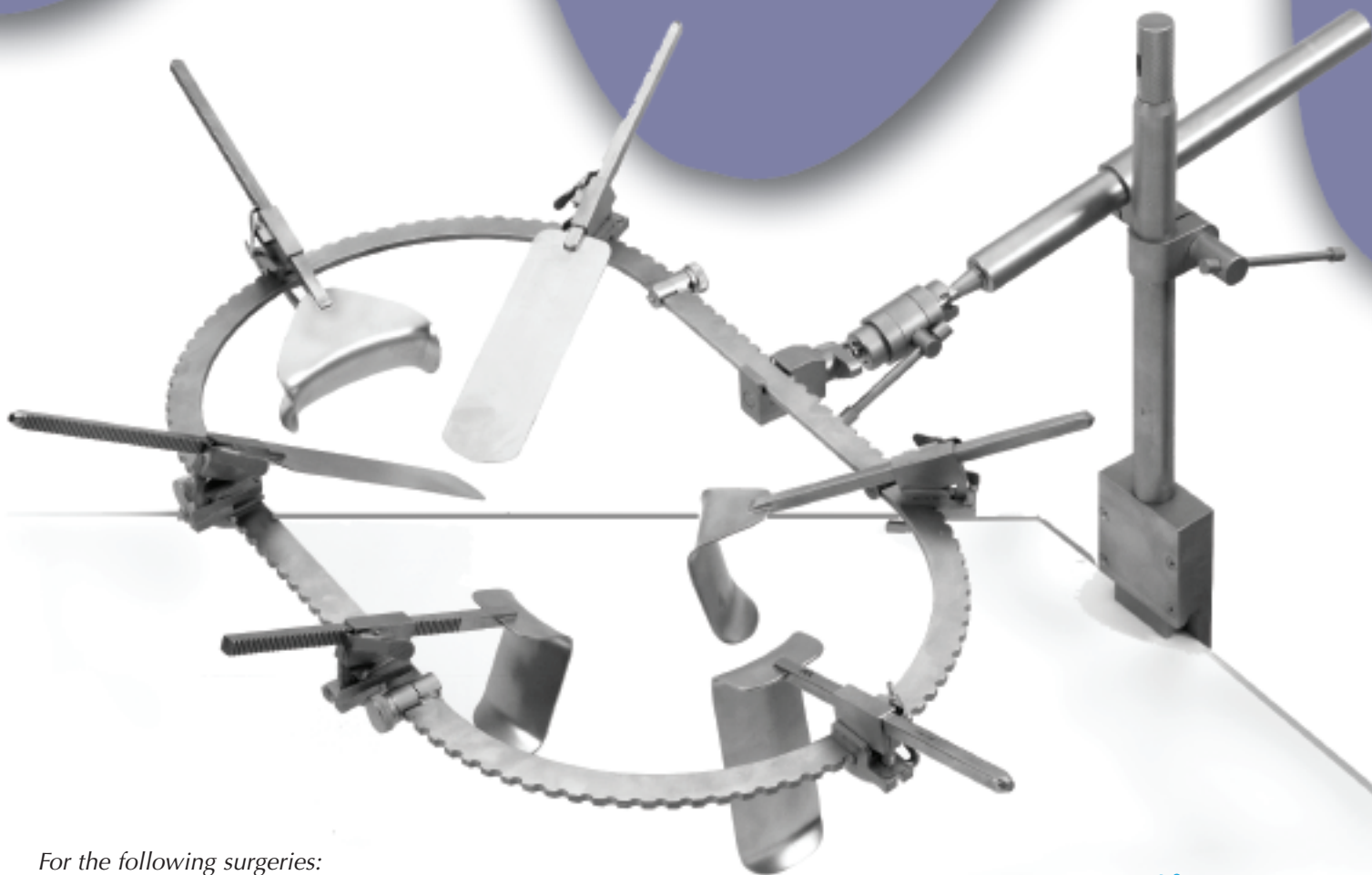

For the following surgeries:

- General
- Urology
- Bariatric
- Vaginal
- Rectal
- Pediatric



**MARINAMEDICAL**  
The New Wave In Surgical Instrumentation

*The Most Comprehensively Designed Surgical Retractor Available Today!*

# Marina Multi-Trac

The **Marina Medical Multiple Retractor Set** (Marina Multi-Trac) has been designed to provide the flexibility necessary for the Operating Room. With almost twenty different ring possibilities and hundreds of retractor blade styles to choose from the Multi-Trac is suited for use in many different specialties and can be configured to fit the special needs of almost any patient.

- Rings ..... 2
- Table Mounting Components ..... 3
- Retractor Blades ..... 4-6
- Sterilization Supplies ..... 6
- Retractor Sets ..... 7-8

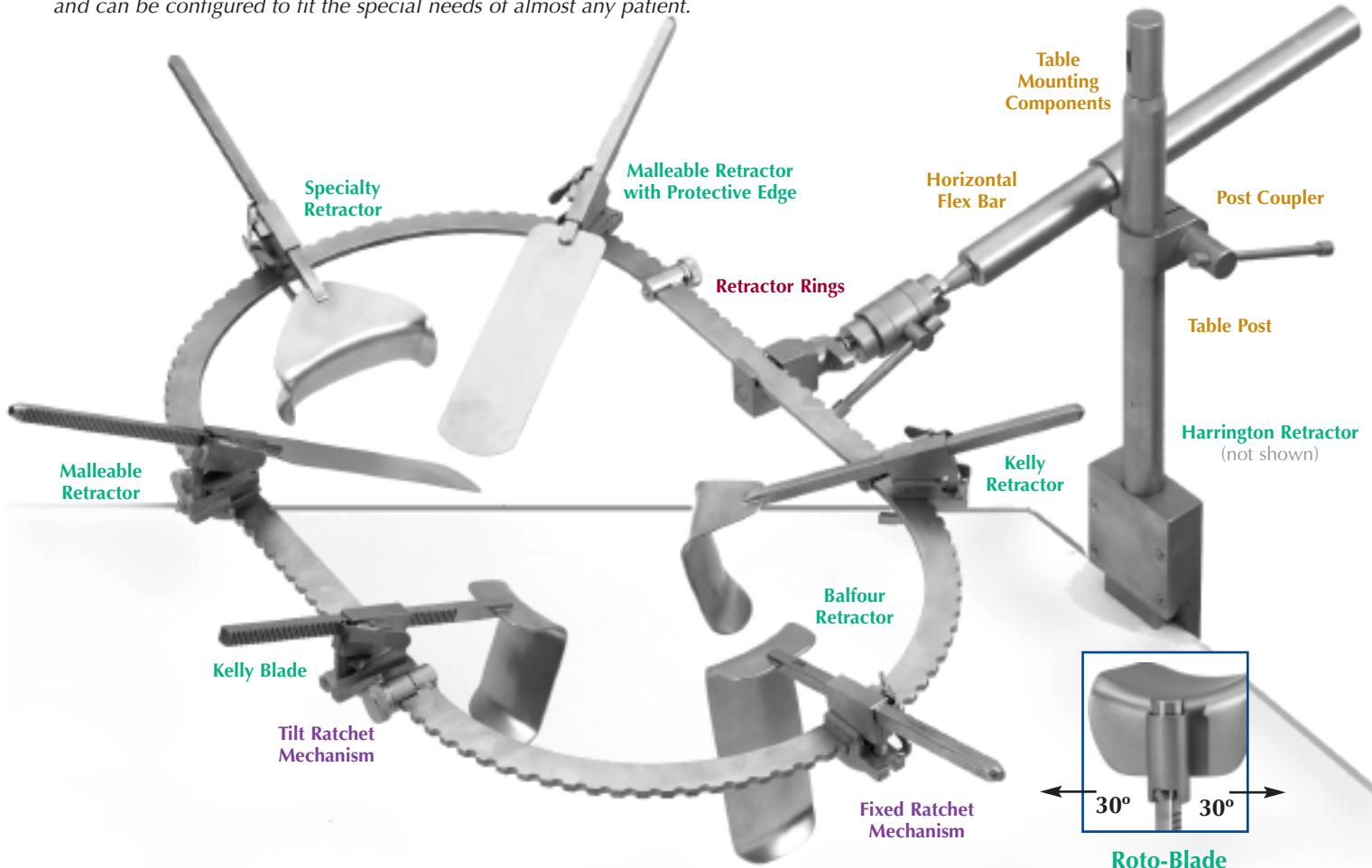

**Roto-Blade**  
Rotates 30° in either direction.  
Available with any blade configuration.

## Assembly Components

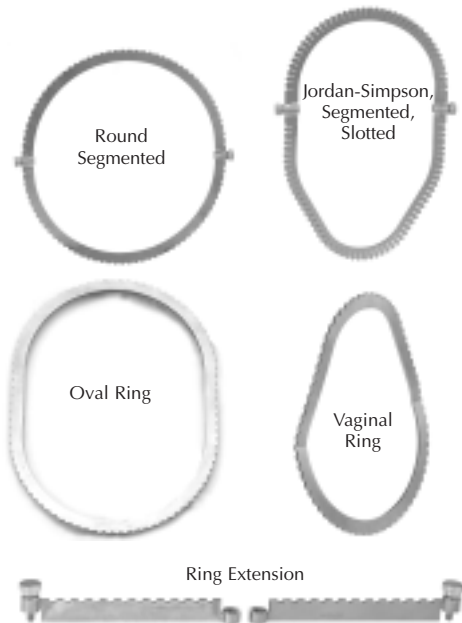

### Rings

Size	Dimension	Product No.
Round Ring, Small	8.5" I.D.	110-716A
Round Ring, Medium	10.5" I.D.	110-716B
Round Ring, Large	12.5" I.D.	110-716C
Oval Ring, Small	13.5" x 8.5"	110-716
Oval Ring, Medium	14.5" x 10.5"	110-717
Oval Ring, Large	18.5" x 12.0"	110-718
Segmented Ring, Medium	19.5" x 10.5"	110-731
Segmented Ring, Oval, Large	12.0" D Oval, 6" Segment	110-803A
Segmented Ring, Oval, Medium	10.0" D Oval, 8" Segment	110-803B
Segmented Ring, Oval, Small	8.0" D Oval, 4" Segment	110-803C
Segmented Ring, Round, Large	12.0"	110-803D
Segmented Ring, Round, Medium	10.0"	110-803E
Segmented Ring, Round, Small	8.0"	110-803F
Vaginal Retractor Ring	8.0" x 10.5	110-917
Jordan-Simpson Retractor Ring, Segmented, Slotted	8.5" I.D.	110-861
Straight Segmented/Extension	4" (pair)	110-803G
Straight Segmented/Extension	6" (pair)	110-803H
Straight Segmented/Extension	8" (pair)	110-803I

# Table Mounting Components

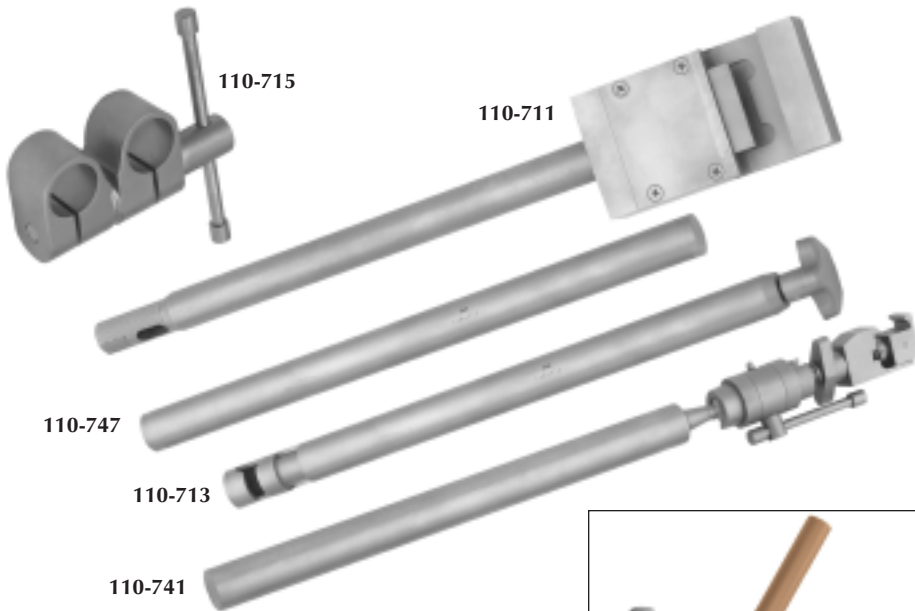

## Table Mounting Components

Item	Product No.
1" Post Coupler	110-715
Table Post, 1", Length: 18"	110-711
Table Post, 1", Length: 24"	110-711XL
Extension Bar (30.5cm/12")	110-747
Horizontal Bar	110-713
Horizontal Flex Bar	110-741

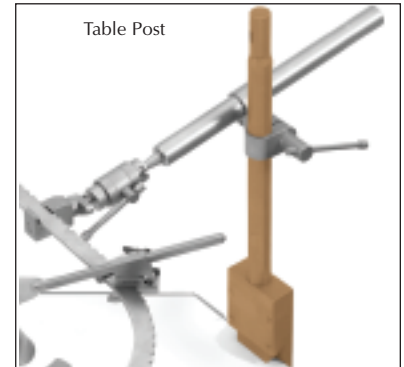
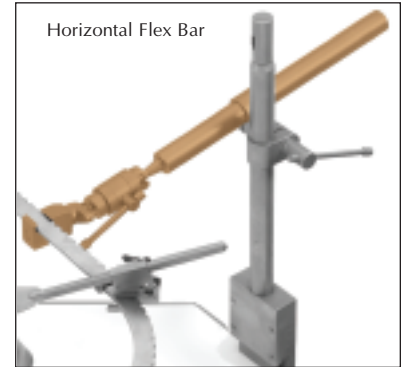
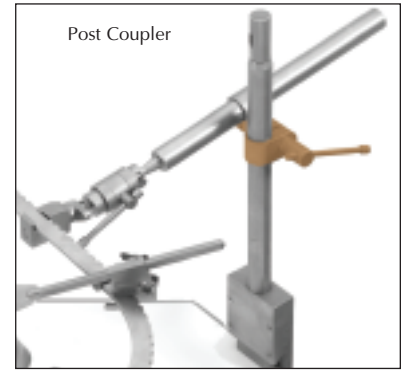

## Fixed Ratchet Mechanism

Allows extension or retraction along the horizontal axis at 2mm intervals.

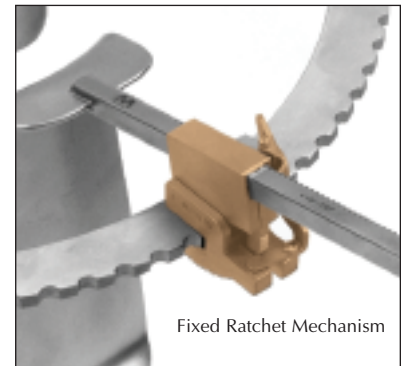
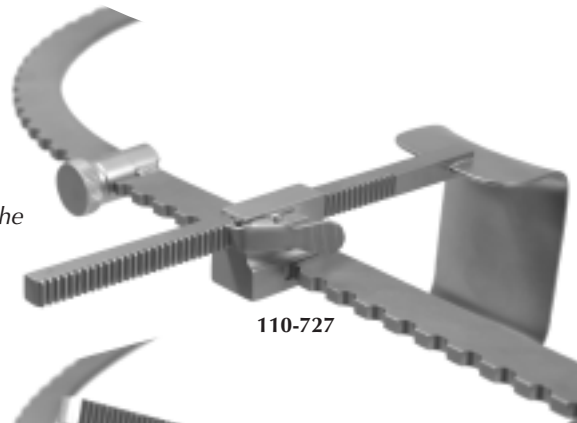

## Tilt Ratchet Mechanism

Allows extension or retraction along the horizontal axis and allows vertical movement of retractor blade with a second ratchet.

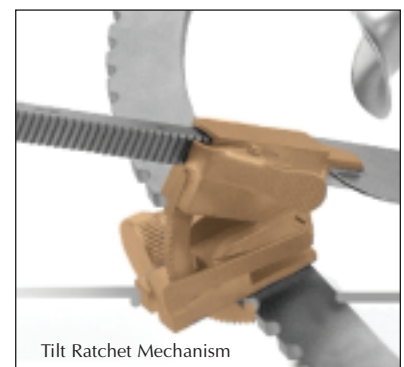

## Ratchet Mechanisms

Item	Product No.
Fixed Ratchet Mechanism	110-727
Tilt Ratchet Mechanism	110-729

# Marina Multiple Retractors

## Kelly Retractors Blades



Description (Width x Length)	Product No.
1" x 1 1/2" Kelly Retractor	110-720
2" x 3" Kelly Retractors	110-721
2" x 4" Kelly Retractors	110-723
2" x 5" Kelly Retractor	110-737
3" x 2 5/8" Kelly Retractor	110-738
2" x 6" Kelly Retractor	110-739
2 5/8" x 3" Kelly Retractor	110-740
1" x 2 1/2" Kelly Retractor	110-742
2" x 7" Kelly Retractor	110-745
2 1/2" x 3" Kelly Retractor	110-834
2" x 2" Kelly Retractor	110-834A
2.5" x 7" Kelly Retractor	110-835
2 1/2" x 8" Kelly Retractor	110-836
2" x 8" Kelly Retractor	110-836A
2 1/2" x 10" Kelly Retractor	110-837
0.75" x 1" Jordan-Richardson-Simpson Retractor	110-877
0.75" x 2" Jordan-Richardson-Simpson Retractor	110-878
1" x 1.25" Jordan-Richardson-Simpson Retractor	110-879

Add **R** to any blade for rotatable  
Custom sizes available

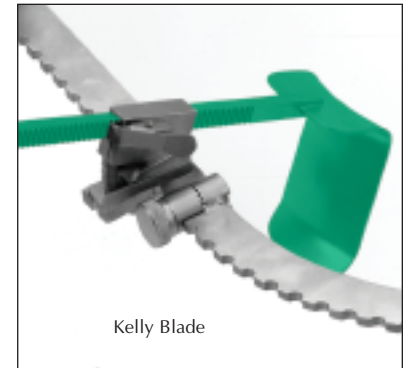

Kelly Blade

## Malleable Retractors Blades

All retractors come with protective edges



Description (Width x Length)	Product No.
2" x 6" Malleable Retractors	110-719
1 1/2" x 6" Malleable Retractor	110-733
3" x 6" Malleable Retractor	110-735
1.5" x 4" Malleable Retractor	110-805
1/2" x 3" Malleable Retractor	110-809
1" x 4" Malleable Retractor	110-810
1" x 5" Malleable Retractor	110-811
1" x 6" Malleable Retractor	110-812
6" x 12" Malleable Retractor	110-813
1" x 9" Malleable Retractor	110-814
2" x 7" Malleable Retractor	110-815
3" x 7" Malleable Retractor	110-816
2" x 9" Malleable Retractor	110-817
2" x 10" Malleable Retractor	110-817A
2" x 12" Malleable Retractor	110-818
3" x 10" Malleable Retractor	110-819
3" x 9" Malleable Retractor	110-819A
3" x 12" Malleable Retractor	110-820
4" x 10" Malleable Retractor	110-821
4" x 9" Malleable Retractor	110-822
4" x 10" Malleable Retractor	110-822A
6" x 12" Malleable Retractor	110-823
1/2" x 3" Malleable Retractor	110-848
3.5cm x 10cm Loughlin-Simpson Retractor	110-856
3.5cm x 13cm Loughlin-Simpson Retractor	110-857
3.5cm x 15cm Loughlin-Simpson Retractor	110-858

Add **R** to any blade for rotatable  
Custom sizes available

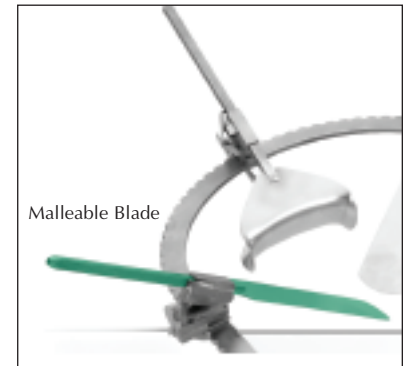

Malleable Blade

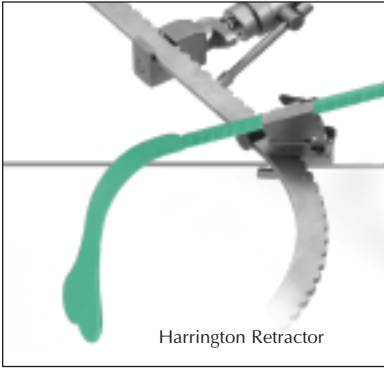

Harrington Retractor

## Harrington Retractor Blades

Description	Product No.
2 1/2" x 5 1/4" Harrington Retractor	110-743
1 1/2" x 5" Baby Harrington Retractor	110-825
2 1/2" x 9" Harrington Retractor	110-826
3 1/2" x 10" Harrington Retractor	110-826A

Add **R** to any blade for rotatable

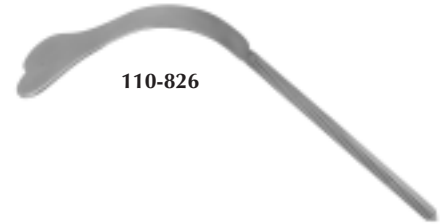

110-826

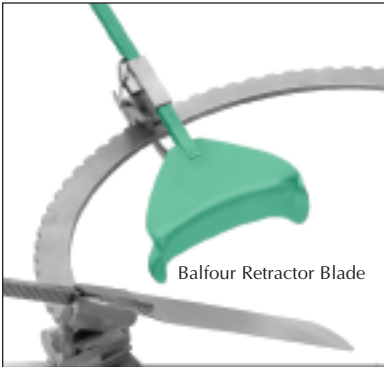

Balfour Retractor Blade

## Balfour Retractors Blades

Description	Product No.
3" x 4" Balfour Retractor	110-724
3 3/8" x 2 3/4" Balfour Retractor	110-725
3 3/8" x 1 1/2" Balfour Retractor	110-725B
3 3/8" x 4" Balfour Retractor	110-725C
4" x 3 3/4" Balfour Blade Retractor	110-827
Goulet-Simpson Retractor, Small 1"	110-867
Goulet-Simpson Retractor, Large 1.5"	110-868

Add **R** to any blade for rotatable



110-867

110-725C

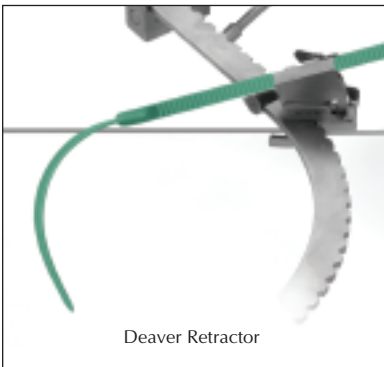

Deaver Retractor

## Deaver Retractor Blades

Description	Product No.
1" x 3.5" Deaver Blade Small	110-921
1" x 7" Deaver Blade Large	110-922
1" x 5" Deaver Blade Large	110-923
2" x 5" Deaver Blade Large	110-924

Add **R** to any blade for rotatable

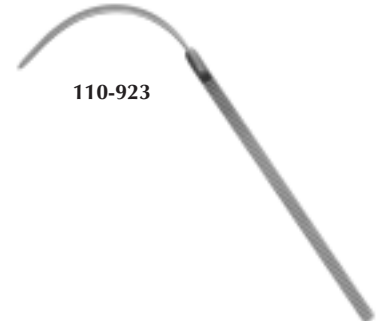

110-923

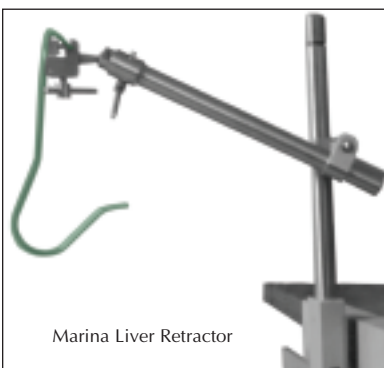

Marina Liver Retractor

## Marina Liver Retractors

Our **Marina Liver Retractors** offer the flexibility and usability that doctors demand. Light weight, solid construction and maximum visibility to ensure proper retraction of the liver with even weight distribution.

Description	Product No.
3mm, Small	CS69703
3mm, Medium	CS69704
3mm, Large	CS69705
5mm, Small	CS69706
5mm, Medium	CS69707
5mm, Large	CS69708





## Specialty Urological Retractor Blades

Description	Product No.
Yu-Holtgrewe Retractor, 2 1/2" x 7" Malleable w/ Simpson Handle	110-840
Carroll Prostatic Retractor, 1 1/2" wide spreads to 3 1/4" x 7" w/ Simpson Handle	110-843
Single Hook Malleable retractor w/ Ball Probe, w/ Simpson Handle	110-845
Double Hook Malleable Retractor, 8mm, w/ Ball Probe, w/ Simpson Handle	110-846

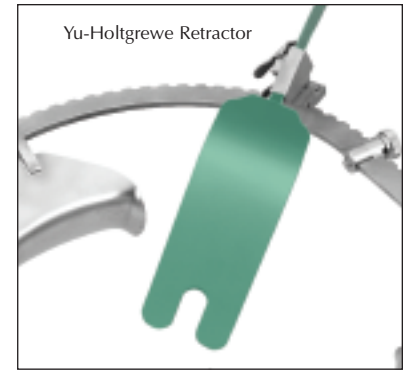

## General Surgery & Deep Pelvic Retractors

Description	Product No.
Gelpi Retractor	110-746
Simpson-St. Mark's Retractor, 5" w/ Lip	110-870
Simpson-St. Mark's Retractor, 6" w/ Lip	110-871
Simpson-St. Mark's Retractor, 7" w/ Lip	110-872
Simpson-St. Mark's Retractor, 7" w/ Lip Angled 15°	110-976
Simpson-St. Mark's Retractor, 7" Narrow w/ Lip	110-975
Simpson-St. Mark's Retractor, 9" w/ Lip	110-977
Simpson-St. Mark's Retractor, 9" w/ Lip, Angled 15°	110-978
Simpson-Wylie Vein Retractor, 1" x 5"	110-873
Simpson-Wylie Vein Retractor, 1" x 6"	110-874
Simpson-Wylie Vein Retractor, 1" x 7"	110-875
Simpson-Wylie Vein Retractor, 1" x 9"	110-876
Simpson-Wylie Radiolucent Vein Retractor, 1" x 5"	110-873RA
Simpson-Wylie Aluminum Radiolucent Vein Retractor, 1" x 6"	110-874RA
Simpson-Wylie Aluminum Radiolucent Vein Retractor, 1" x 7"	110-875RA
Simpson-Wylie Radiolucent Vein Retractor, 1" x 9"	110-876RA
Simpson-Murphy Gall Bladder Retractor, 2" wide	110-980

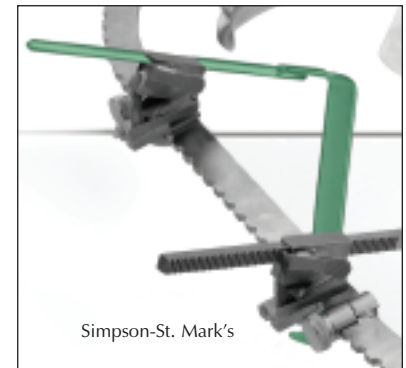

Add **R** to any blade for rotatable

## Sterilization Supplies

### Sterilization Filters

Disposable Sterisheet™, natural, 100% cellulose material, water repellent. Available with or without dual chemical indicator dot on filter. (For both EtO and Steam cycles)

Description	Product No.
9.5" x 9.5", with indicator, 100 per case	CA3010
9.5" x 9.5", without indicator, 100 per case	CA3001

### Pull Tight™ Locks

A plastic seal that fits through the channel on the locking pin and locks. Must be broken to open container. Available with or without dual chemical indicator dot.

Description	Product No.
White, with indicator, 100 per case	CA1030
White, without indicator, 100 per case	CA1034

### Internal Indicator Strips

With dual chemical indicator.

Description	Product No.
4 1/4" W x 1 11/16" L, 250 per case	CA2010

### External Processing Cards

With dual chemical indicator strip.

Description	Product No.
2 3/4" x 1 3/16", 250 per case	CA2000

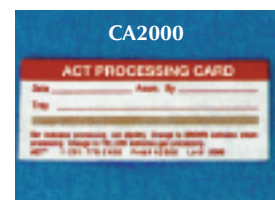

# Marina Retractor Sets

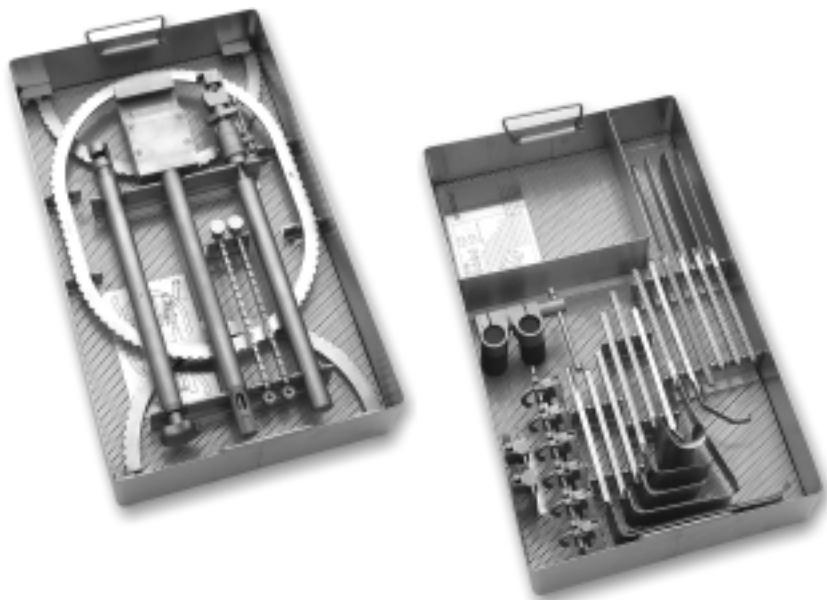

## Marina Multi-Trac Retractor Set

Description	Product No.
Table Post, 1", Length: 18"	110-711
Horizontal Flex Bar	110-741
Horizontal Bar	110-713
1" Post Coupling	110-715
Medium Oval Ring (14.5" x 10.5")	110-717
Segmented Ring (49.5cm x 26.5cm / 19.5" x 10.5")	110-731
Ratchet Mechanisms (2)	110-727
Tilt Ratchet Mechanisms (6)	110-729
2" x 3" Kelly Retractors (2)	110-721
2" x 4" Kelly Retractors	110-723
2" x 5" Kelly Retractor	110-737
2" x 6" Kelly Retractor	110-739
Balfour Retractor, 3 3/8" x 2 3/4"	110-725
1 1/2" x 6" Malleable Retractor	110-733
2" x 6" Malleable Retractors (2)	110-719
3" x 6" Malleable Retractor	110-735
2 1/2" x 5 1/4" Harrington Retractor	110-743
Gelpi Retractor	110-746

### Accessories

Table Fixation & Ring Case	110-760
Blades & Accessories Case	110-770

## Marina Vaginal Multi-Trac Retractor Set

Description	Product No.
Vaginal Retractor Ring, 8" x 10.5"	110-917
Posterior Blade, 1" x 4.5"	110-925
Lateral Retractor Blade, 1" x 3" ( 2 per Set )	110-919
Deaver Blade, Small, 1" x 3.5"	110-921
Deaver Blade, Large, 1" x 5"	110-923

### Other blades useful for vaginal surgery:

Malleable Retractor, 1" x 5" w/ Protective Edge	110-811
Malleable Retractor, 1" x 6" w/ Protective Edge	110-812
Malleable Retractor, 1/2" x 3" w/ Lip	110-848
Malleable Retractor, 1" x 4" w/ Protective Edge	110-810
Malleable Retractor, 1.5" x 4" w/ Protective Edge	110-805
Single Hook Malleable Retractor w/ Ball Probe, w/ Simpson Handle	110-845
Double Hook Malleable Retractor, 8mm, w/ Ball Probe, w/ Simpson Handle	110-846

## Marina Bariatric Multi-Trac Retractor Set

Description	Product No.
Table Post, 1", Length: 18"	110-711
Horizontal Bar	110-713
1" Post Coupling	110-715
Horizontal Flex Bar	110-741
Medium Oval Ring, 14.5" x 10.5"	110-717
Vertical Extension Bar, 30.5cm / 12"	110-747
Malleable Retractor, 2" x 10" w/ Protective Edge	110-817A
Malleable Retractor, 3" x 10" w/ Protective Edge	110-819
Malleable Retractor, 4" x 10" w/ Protective Edge	110-822A
Kelly Retractor, 2" x 3"	110-721
Kelly Retractor, 2" x 4"	110-723
Kelly Retractor, 2" x 8"	110-836A
Balfour Blade Retractor, 4" x 3 3/4"	110-827
Harrington Retractor, 3 1/2" x 10"	110-826A

### Optional:

Exchange 24" Table Post for 18" Table Post	110-711XL
--	-----------

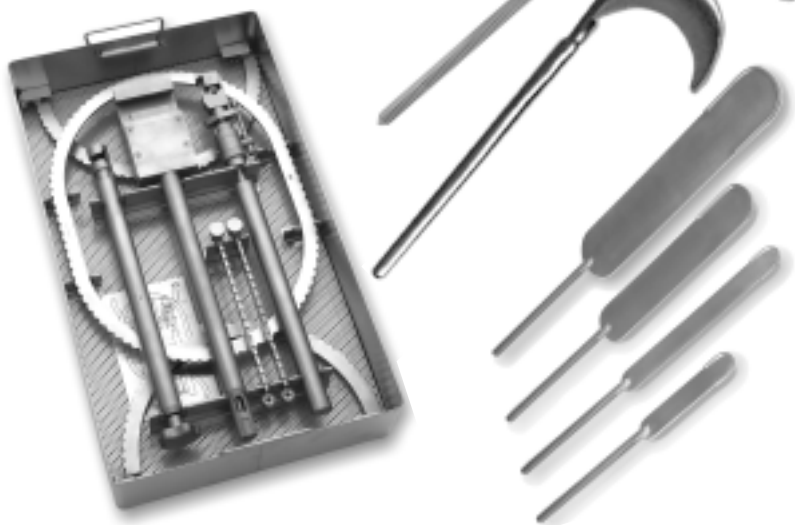

Jordan-Simpson Perineal Set



## Jordan-Simpson Perineal Retractor Set

<i>Description</i>	<i>Product No.</i>
Jordan-Simpson Segmented Retractor Ring, Slotted	<b>110-861</b>
Jordan-Simpson 3 Prong Retractor w/ Rotational Handle (2)	<b>110-862</b>
Jordan-Simpson 4 Prong Retractor w/ Rotational Handle (2)	<b>110-863</b>
Jordan-Simpson Right Angled Retractor 1"	<b>110-864</b>
Jordan-Simpson Right Angled Retractor 1 1/2"	<b>110-865</b>
Jordan-Richardson-Simpson Retractor, 1" x 1 1/2"	<b>110-866</b>
Goulet-Simpson Retractor, Small 1"	<b>110-867</b>

Walther-Simpson Perineal Set

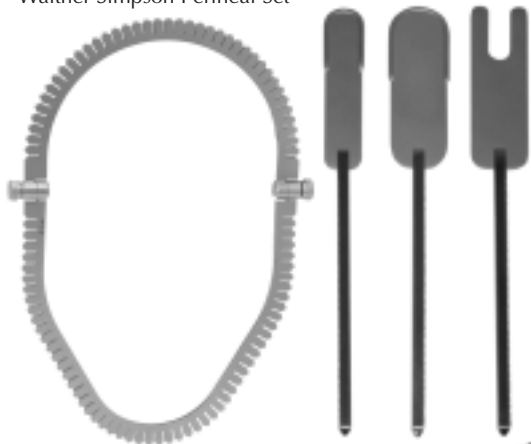

## Walther-Simpson Perineal Retractor Set

<i>Description</i>	<i>Product No.</i>
Jordan-Simpson Segmented Retractor Ring, Slotted	<b>110-861</b>
Malleable Retractor, 1" x 4" w/ Protective Edge (2)	<b>110-810</b>
Malleable Retractor, 1.5" x 4" w/ Protective Edge	<b>110-805</b>
1 1/2" x 4" Walther-Simpson Notched Retractor	<b>110-854</b>

Marina Rectal Multi-Trac Retractor Set

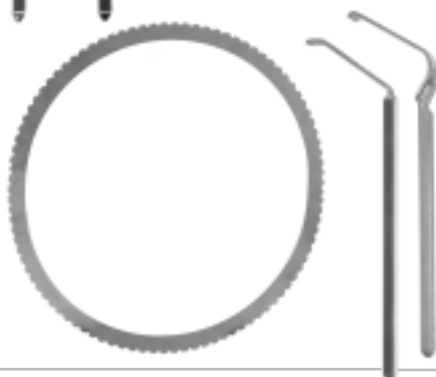

## Marina Rectal Multi-Trac Retractor Set

<i>Description</i>	<i>Product No.</i>
Rectal Ring , Round, 8.5" Diameter, Slotted	<b>110-881</b>
Fenestrated Rectal Blade, 7cm, angled (4)	<b>110-882</b>
Solid Rectal Blade, 7cm, Angled, w/Teeth (4)	<b>110-883</b>

## Sterilization Containers & Baskets

The many components of the **Multi-Trac Retractor Set** can all be neatly arranged into autoclave sized containers with diagrams that direct instrument handlers on proper placement of each component. A major convenience in care and maintenance of the Retractor Set.

<i>Description</i>	<i>Product No.</i>
Table Fixation & Ring Case	<b>110-760</b>
Blades & Accessories Case	<b>110-770</b>

